

TLS-450PLUS Console

Troubleshooting Guide

Notice

Veeder-Root makes no warranty of any kind with regard to this publication, including, but not limited to, the implied warranties of merchantability and fitness for a particular purpose.

Veeder-Root shall not be liable for errors contained herein or for incidental or consequential damages in connection with the furnishing, performance, or use of this publication.

Veeder-Root reserves the right to change system options or features, or the information contained in this publication.

This publication contains proprietary information which is protected by copyright. All rights reserved. No part of this publication may be photocopied, reproduced, or translated to another language without the prior written consent of Veeder-Root.

Contact TLS Systems Technical Support for additional troubleshooting information at 800-323-1799.

DAMAGE CLAIMS / LOST EQUIPMENT

Thoroughly examine all components and units as soon as they are received. If any cartons are damaged or missing, write a complete and detailed description of the damage or shortage on the face of the freight bill. The carrier's agent must verify the inspection and sign the description. Refuse only the damaged product, not the entire shipment.

Veeder-Root must be notified of any damages and/or shortages within 30 days of receipt of the shipment, as stated in our Terms and Conditions.

VEEDER-ROOT'S PREFERRED CARRIER

1. Contact Veeder-Root Customer Service at 800-873-3313 with the specific part numbers and quantities that were missing or received damaged.
2. Fax signed Bill of Lading (BOL) to Veeder-Root Customer Service at 800-234-5350.
3. Veeder-Root will file the claim with the carrier and replace the damaged/missing product at no charge to the customer. Customer Service will work with production facility to have the replacement product shipped as soon as possible.

CUSTOMER'S PREFERRED CARRIER

1. It is the customer's responsibility to file a claim with their carrier.
2. Customer may submit a replacement purchase order. Customer is responsible for all charges and freight associated with replacement order. Customer Service will work with production facility to have the replacement product shipped as soon as possible.
3. If "lost" equipment is delivered at a later date and is not needed, Veeder-Root will allow a Return to Stock without a restocking fee.
4. Veeder-Root will NOT be responsible for any compensation when a customer chooses their own carrier.

RETURN SHIPPING

For the parts return procedure, please follow the appropriate instructions in the "General Returned Goods Policy" pages in the "Policies and Literature" section of the Veeder-Root **North American Environmental Products** price list. Veeder-Root will not accept any return product without a Return Goods Authorization (RGA) number clearly printed on the outside of the package.

1 Introduction	
Related Manuals	1-1
Contractor Certification Requirements	1-1
Safety Precautions	1-2
Safety Warnings	1-2
2 System Description	
System Parts Identification	2-1
About Screen	2-11
Console Power And Relay Wiring Inputs	2-11
Configuration DIP Switch Settings	2-11
Basic Troubleshooting Procedures	2-12
Intrinsic Safety Check	2-12
Visual Inspection of Console Interior	2-13
3 Fuses	
Power Supply Fuses	3-1
Module Fuses	3-1
4 Diagnostics	
AccuChart	4-1
Available Diagnostic Screens	4-1
BIR	4-1
Available Diagnostic Screens	4-1
LPR Sensor	4-1
Available Line Pressure Sensor Diagnostic Reports	4-2
Mag Sensor	4-2
Available Mag Sensor Diagnostic Reports	4-2
Meter	4-2
Available Diagnostic Screens	4-2
Miscellaneous	4-2
Module	4-2
Available Diagnostic Screens	4-3
PLLD	4-3
Available PLLD Diagnostic Reports and screens	4-3
Probe	4-3
Available Probe Diagnostic Reports And Screens	4-3
Relays and Inputs	4-4
Available Diagnostic Screens	4-4
Sensors	4-4
Available Sensor Diagnostic Reports	4-4
Tank	4-4
Available Tank Diagnostic Reports.....	4-4
Tank Test	4-4
Available Tank Test Diagnostic Reports.....	4-5
5 Warning and Alarm Messages	
Device Identifiers	5-1
Displayed Alarm Messages	5-2

6 Console Troubleshooting	
Boot-Up LED Sequence	6-1
TLS-450PLUS Troubleshooting Guide	6-2
7 Component Removal	
Safety Warnings	7-1
Precautions Against Static Electricity	7-1
Before Turning Off Power	7-2
Removing The Ack Switch Panel/Display (Right) Door And CPU Board	7-3
Removing The AC Input Filter And Power Supply Board	7-5
Removing The Printer/Blank (Left) Door	7-9
Removing The Backup Battery	7-10
Removing The Features iButton	7-11
Removing The SD Card	7-12
Removing The SATA Drive	7-13
8 Console Diagnostics Using The TLSTECH Diagnostic Tool	
Downloading and Using Putty	8-1
Reconfigure the Laptop PC Prior To Using TLSTECH	8-1
Laptop/PC Setup for A Windows 7 Operating System	8-1
Laptop/PC Setup for A Windows XP Operating System	8-4
Using Putty And The TLSTECH Diagnostic Tool	8-6
TLSTECH Menu Examples	8-8
Menu selection 1	8-9
Menu selection 4	8-9
Menu selection 5	8-10
Menu selection 6	8-10
Menu selection 7	8-10
Menu selection 8	8-11
Menu selection 9	8-12
9 Probe Troubleshooting	
Field Troubleshooting Probe-Out Alarms	9-3
Minimum Detected Fluid Levels	9-5
Mag Probe Channel Counts in Common Liquids	9-6
10 Sensor Troubleshooting	
Sensor Alarm Will Not Clear	10-1
Sensor Out Alarms	10-1
Setup Data Warning	10-1
Unstable Sensor Readings	10-1
Cleaning Fuel Contaminated Discriminating Sensors	10-2
Discriminating Sensors 794380-320, -322, -350, -352	10-2
Discriminating Solid-State Sensor - Optical (P/N 794380-343, -344)	10-2
Sensor Troubleshooting	10-2
Comm Alarms	10-2
Mag Sensor	10-2
11 CSLD Troubleshooting	
CSLD Tank Limitations	11-1
Maximum Tank Capacity	11-1
Monthly Throughput Guidelines	11-1
CSLD Block Diagrams	11-1
CSLD Diagnostic Aids	11-4

Tank Setup Check Before Troubleshooting	11-8
CSLD Alarms	11-8
Alarm: CSLD RATE INCR WARN	11-9
Alarm: NO CSLD IDLE TIME.....	11-10
Alarm: PERIODIC LEAK TEST FAIL.....	11-11
Status Message: NO RESULTS AVAILABLE	11-11
Static Leak Test	11-12
When to Manually Clear the CSLD Rate Table	11-12
Contacting Tech Support	11-13
Actual CSLD Test Problems Analyzed	11-14
CSLD Problem 1 - TANK 1 CSLD FAIL.....	11-14
Diagnostics.....	11-14
Analysis of Rate Table (IA51).....	11-16
Analysis of Rate Test (IA52).....	11-17
Solution.....	11-17
CSLD Problem 2 - Manifolder Tanks 1 And 2 Are Failing	11-17
Diagnostics.....	11-17
CSLD Problem 3 - Increase Rate Warning for Manifolder Tanks 2 and 3.....	11-19
CSLD Problem 4 - No CSLD Idle Time	11-20
CSLD Problem 5 - Tank 1 Is Failing.....	11-22
CSLD Problem 6 - CSLD Periodic Failure Tank 1.....	11-24
CSLD Problem 7 - No CSLD Results	11-29
CSLD Problem 8 - CSLD Failure Tank 1.....	11-30
CSLD Problem 9 - Tank 1 Fail.....	11-33
CSLD Problem 10 - Tank 8 Failing.....	11-36
CSLD Problem 11 - Periodic Test Fail Tank 2.....	11-37
CSLD Problem 12 - Periodic Test Fail on Tank 1.....	11-38

Figures

Figure 2-1. Console Front Panel	2-1
Figure 2-2. Printer Door Assembly	2-2
Figure 2-3. Display Door Assembly	2-3
Figure 2-4. Console Board Locations (With Power Supply Protective Cover Removed)	2-4
Figure 2-5. AC Input Board	2-5
Figure 2-6. Power Supply Board	2-6
Figure 2-7. I/O Backplane Board	2-7
Figure 2-8. Comm Backplane Board	2-8
Figure 2-9. TLS-450PLUS Console - Selectable Comm Modules	2-9
Figure 2-10. TLS-450PLUS Console - Fixed Comm Modules	2-9
Figure 2-11. CPU Board	2-10
Figure 2-12. Configuration DIP Switch Settings	2-11
Figure 7-1. USB Board - USB Ports	7-2
Figure 7-2. DB Backup Screen	7-2
Figure 7-3. Remove Optional Printer And Display Cables From CPU Board	7-3
Figure 7-4. Remove Ground Wire From Ack Switch/Display Door	7-4
Figure 7-5. Remove Top And Bottom Optional Display Door Hinge Screws	7-4
Figure 7-6. Remove USB Module Cables From CPU Board	7-5
Figure 7-7. Remove Ethernet Module Cables From CPU Board	7-5
Figure 7-8. Remove AC Channel Cover	7-6
Figure 7-9. Removing AC Input Filter	7-7
Figure 7-10. Removing Power Supply Board	7-8
Figure 7-11. Replacing Power Supply shield over Power Supply board	7-9

Figure 7-12. Removing Printer Door Ground Wire7-10
 Figure 7-13. Removing Printer Door Ground Wire7-10
 Figure 7-14. Locating Features iButton And Backup Battery7-11
 Figure 11-1. CSLD Decision Process Block Diagram11-2
 Figure 11-2. CSLD Leak Test Timing Sequence11-3
 Figure 11-3. CSLD Rate Table Example11-5
 Figure 11-4. CSLD Rate Test Example11-6
 Figure 11-5. CSLD Volume Table Example11-7
 Figure 11-6. CSLD Moving Average Table Example11-8

Tables

Table 2-1. Selectable Comm Module Permissible Slots and Port Availability2-9
 Table 2-2. TLS-450PLUS Wiring Inputs2-11
 Table 3-1. Power Supply/AC Input board fuses3-1
 Table 3-2. I/O Module Fuses3-1
 Table 5-1. System Alarms5-2
 Table 5-2. Tank Alarms5-3
 Table 5-3. Liquid Sensor Alarms5-5
 Table 5-4. Vapor Sensor Alarms5-6
 Table 5-5. External Input Alarms5-6
 Table 5-6. Groundwater Sensor Alarms5-6
 Table 5-7. Type A Sensor Alarms5-7
 Table 5-8. Type B Sensor Alarms5-7
 Table 5-9. Relay Alarms5-8
 Table 5-10. Pressure Line Leak Alarms5-8
 Table 5-11. Mag Sensor Alarms5-9
 Table 5-12. Line Pressure Sensor Alarms5-10
 Table 5-13. Printer Alarms5-10
 Table 5-14. Pump Alarms5-10
 Table 5-15. Line Alarms5-10
 Table 5-16. Communication Alarms5-10
 Table 5-17. Contact Alarms5-11
 Table 5-18. Auto Events Alarms5-11
 Table 5-19. Product Alarms5-11
 Table 5-20. DIM Alarms5-11
 Table 6-1. Front Panel LED Normal Boot-Up Sequence6-1
 Table 6-2. TLS-450PLUS Troubleshooting6-2
 Table 9-1. Mag Probe Troubleshooting9-1
 Table 9-2. Mag Probe Minimum Detected Fluid Levels9-5
 Table 9-3. Mag Probe Channel Counts in Common Liquids9-6
 Table 11-1. Tank Capacity / Monthly Throughput Limitations*11-1

1 Introduction

This manual contains troubleshooting information for the TLS-450PLUS console. Most of the components discussed in this manual are to be replaced if faulty. The intent of this manual is to help you identify replaceable parts and assemblies and to provide accepted troubleshooting methods where applicable. Information on individual plug-in modules is covered in manuals accompanying those components and/or systems.

Related Manuals

Troubleshooting of a TLS-450PLUS console requires knowledge of the system site prep and installation as well as setup and operation of all installed options. Refer to the Tech Docs CD-ROM (V-R P/N 331650-001) for all relevant manuals:

577013-934	TLS-450 & TLS-450PLUS Consoles Site Prep Certification Manual
577013-950	TLS-450/TLS-450PLUS/TLS4 Console Serial Interface Manual
577014-048	TLS-450 to TLS-450PLUS Console Upgrade Instructions
577014-072	TLS-450PLUS Operator's Quick Help
577014-073	TLS-450PLUS Console Site Prep And Installation Manual
577014-074	TLS-350 to TLS-450PLUS Console Upgrade Instructions
577014-075	TLS-450PLUS Console Troubleshooting Guide
577014-076	TLS-450PLUS Console Board and Software Replacement/Upgrade Manual
577014-077	TLS-450PLUS Console Module Replacement Instructions
577014-078	TLS-450PLUS Console Hardware Replacement Guide
577013-344	PLLD Troubleshooting Manual
577013-401	TLS Consoles Point-of-Sale (POS) Application Guide

Contractor Certification Requirements

Veeder-Root requires the following minimum training certifications for contractors who will install and setup the equipment discussed in this manual:

Installer Certification (Level 1): Contractors holding valid Installer Certification are approved to perform wiring and conduit routing; equipment mounting; probe, sensor and carbon canister vapor polisher installation; wireless equipment installation; tank and line preparation; and line leak detector installation.

Technician Certification (Level 2/3): Contractors holding valid Technician Certifications are approved to perform installation checkout, startup, programming and operations training, system tests, troubleshooting and servicing for all Veeder-Root Series Tank Monitoring Systems, including Line Leak Detection. In addition, Contractors with the following sub-certification designations are approved to perform installation checkout, startup, programming, system tests, troubleshooting, service techniques and operations training on the designated system.

- Wireless 2
- Tall Tank

VR Vapor Products Certification: Contractors holding a certification with the following designations are approved to perform installation checkout, startup, programming, system tests, troubleshooting, service techniques and operations training on the designated system.







- ISD – In Station Diagnostics
- PMC – Pressure Management Control
- CCVP - Veeder-Root Vapor Polisher

- Wireless – ISD/PMC Wireless
- A current Veeder-Root Technician Certification is a prerequisite for the VR Vapor Products course.

Warranty Registrations may only be submitted by selected Distributors.



Safety Precautions

The following safety symbols may be used throughout this manual to alert you to important safety hazards and precautions

 <p>EXPLOSIVE Fuels and their vapors are extremely explosive if ignited.</p>	 <p>FLAMMABLE Fuels and their vapors are extremely flammable.</p>
 <p>ELECTRICITY High voltage exists in, and is supplied to, the device. A potential shock hazard exists.</p>	 <p>TURN POWER OFF Live power to a device creates a potential shock hazard. Turn Off power to the device and associated accessories when servicing the unit.</p>
 <p>WARNING Heed the adjacent instructions to avoid damage to equipment, property, environment or personal injury.</p>	 <p>STATIC SENSITIVE COMPONENTS Wear grounded anti-static wrist strap before handling the printed circuit board and mounted components</p>
 <p>READ ALL RELATED MANUALS Knowledge of all related procedures before you begin work is important. Read and understand all manuals thoroughly. If you do not understand a procedure, ask someone who does..</p>	

Safety Warnings

 **WARNING**

  	<p>This system operates near highly combustible fuel storage tanks.</p> <p>FAILURE TO COMPLY WITH THE FOLLOWING WARNINGS AND SAFETY PRECAUTIONS COULD CAUSE DAMAGE TO PROPERTY, ENVIRONMENT, RESULTING IN SERIOUS INJURY OR DEATH.</p> <p>To ensure proper installation, operation, and continued safe use of this product:</p> <ol style="list-style-type: none"> 1. Read and follow all instructions in this manual, including all safety warnings. 2. Have equipment installed by a contractor trained in its proper installation and in compliance with all applicable codes including: the National Electrical Codes; federal, state, and local codes; and other applicable safety codes. 3. Before working on this console, turn off, tag and lockout power to the console. 4. Substitution of components may impair intrinsic safety. 5. Do not modify or use service parts other than those provided by Veeder-Root.
--------------------------------------------------------------------------------------------------------------------------------------------------------------------------------------------------------------------------------------------------------------------	-----------------------------------------------------------------------------------------------------------------------------------------------------------------------------------------------------------------------------------------------------------------------------------------------------------------------------------------------------------------------------------------------------------------------------------------------------------------------------------------------------------------------------------------------------------------------------------------------------------------------------------------------------------------------------------------------------------------------------------------------------------------------------------------------------------------------------------------------------------------------------------------------------------------------------------------------------------------------------------------------------------------------------------------

2 System Description

System Parts Identification

The following figures identify the components and printed circuit boards of the TLS-450PLUS console.

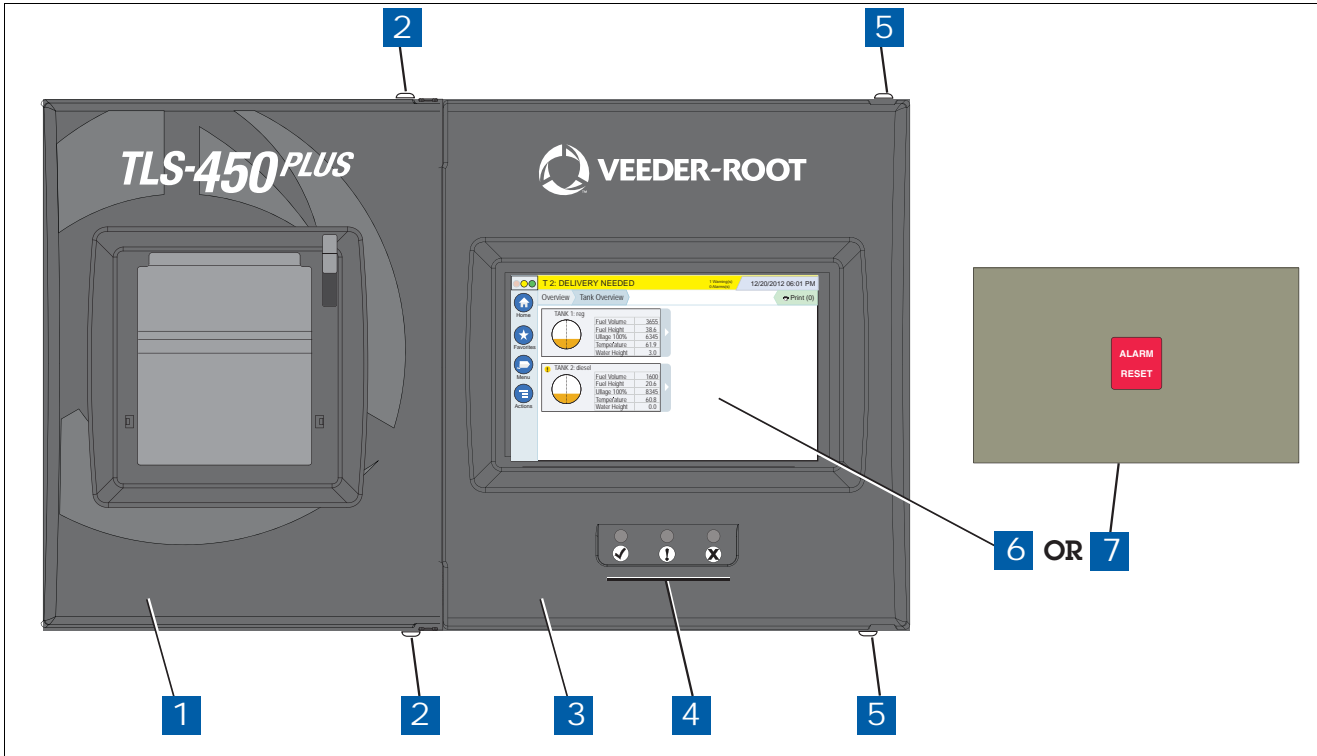

Figure 2-1. Console Front Panel

Legend For Figure 2-1			
Item	Description	Item	Description
1	Left door (showing optional printer)	6	Optional Graphical User Interface (GUI) touch display
2/5	T-15 Torx screws, remove to open doors and access system components	7	Acknowledge (ACK) Switch panel
3	Right door		
4	LED Status indicators: ✓ System Normal (Green); ✘ Warning (Yellow); ! Alarm (Red)		

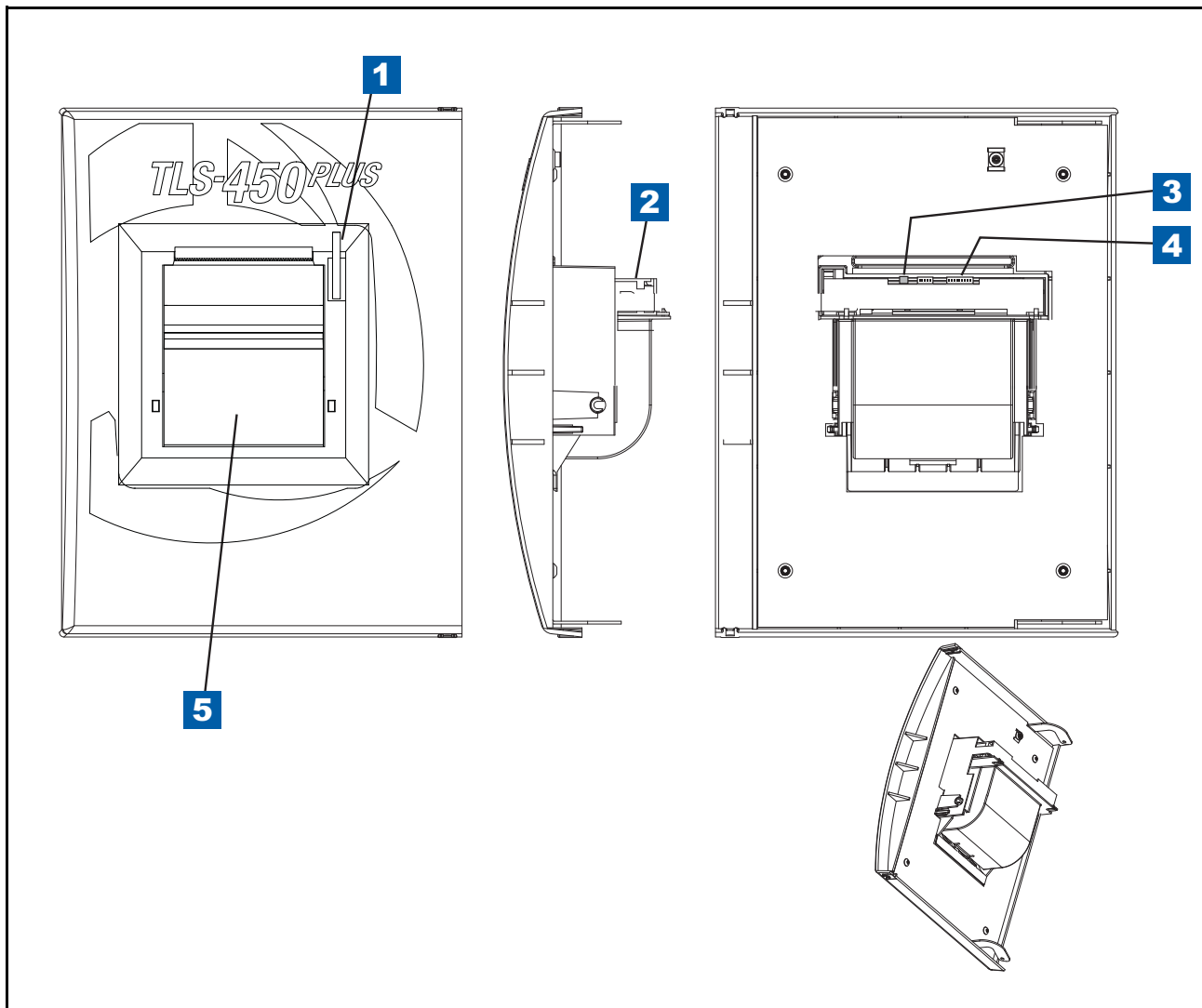

Figure 2-2. Printer Door Assembly

Legend For Figure 2-2			
Item	Description	Item	Description
1	Paper roll release lever	4	Connector for data input cable to USB1 on CPU board
2	Printer assembly	5	Paper cover
3	Connector for power input cable to J1 on Power Supply board		

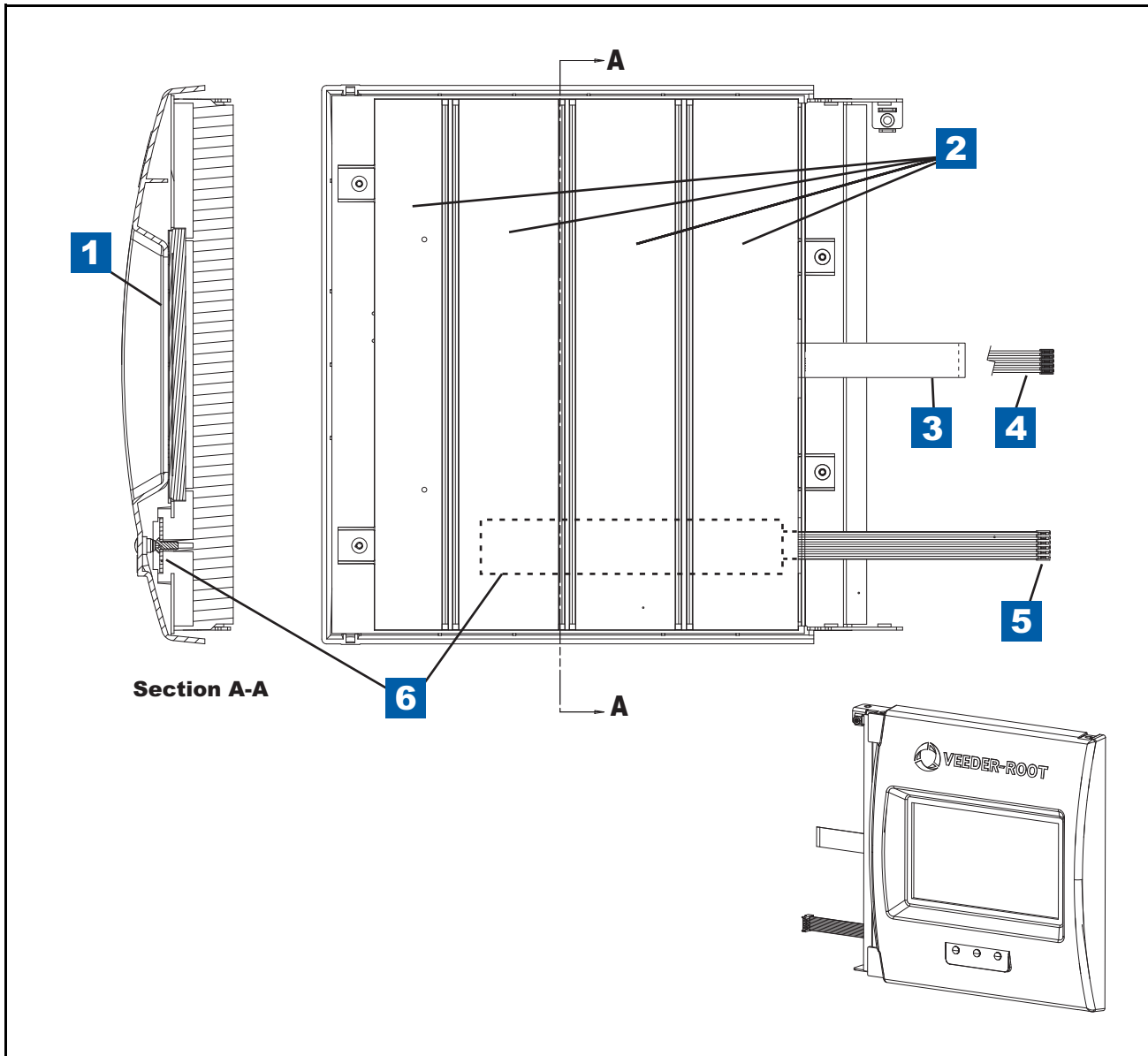

Figure 2-3. Display Door Assembly

Legend For Figure 2-3			
Item	Description	Item	Description
1	Touch screen display assembly	4	Cable to Ack Switch Panel connector on CPU board (item 16 in Figure 2-11)
2	Input Module Connection Labels	5	Cable to LED Backlight connector on CPU board (item 11 in Figure 2-11)
3	Cable to Data Display connector on CPU board (item 6 in Figure 2-11). Data Display is an option.	6	Front panel system status LED board assembly

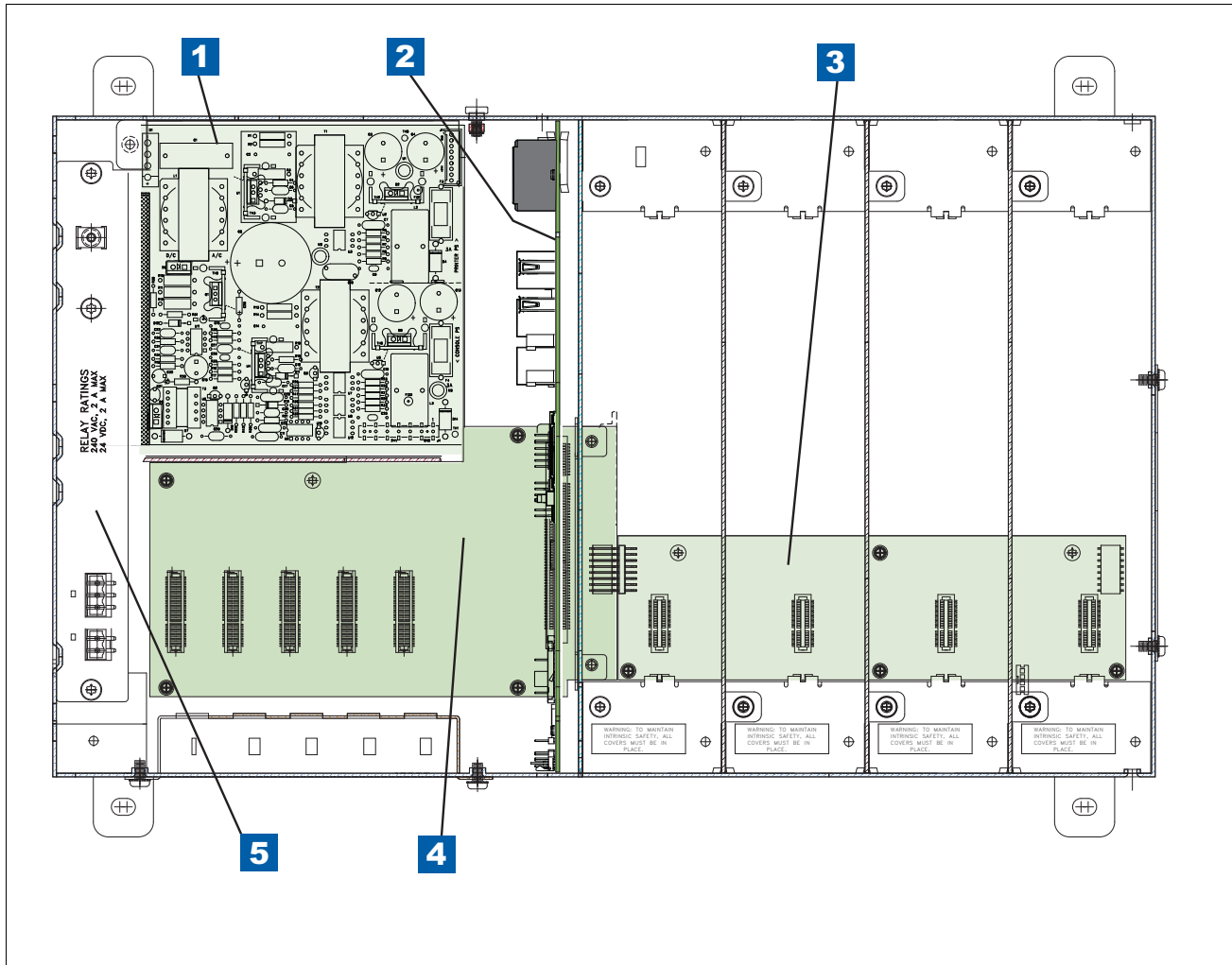

Figure 2-4. Console Board Locations (With Power Supply Protective Cover Removed)

Legend For Figure 2-4			
Item	Description	Item	Description
1	Power Supply board (access cover removed)	4	Comm Backplane board
2	CPU board	5	AC Input board assembly (access cover removed)
3	I/O Backplane board		

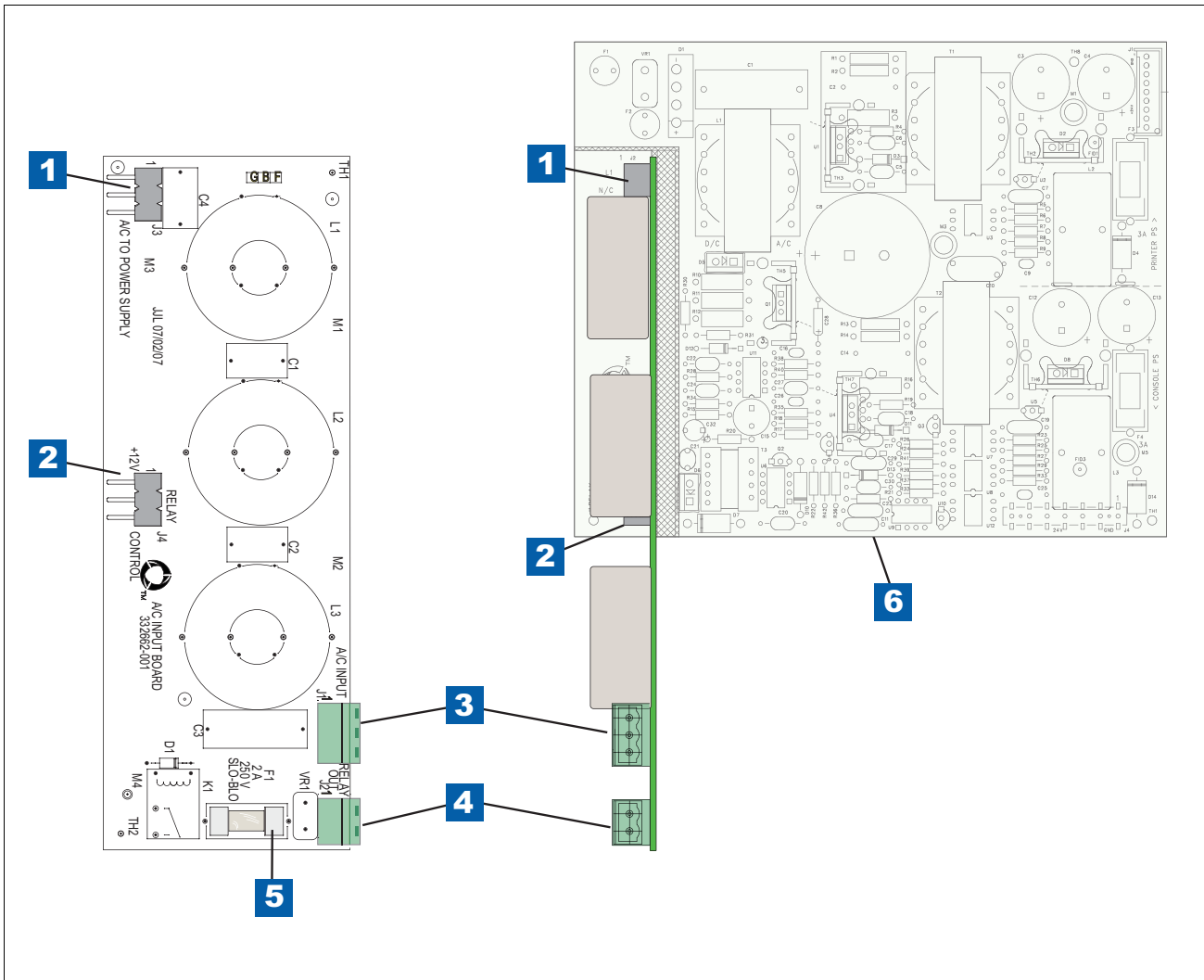

Figure 2-5. AC Input Board

Legend For Figure 2-5			
Item	Description	Item	Description
1	Console AC Input plugs into J2 on Power Supply board	5	Relay output fuse, 2A 250V Slo-Blo
2	Output relay control plugs into J3 on Power Supply board	6	AC Input board plugs into Power Supply board as shown
3	AC input power connector		
4	Output relay control connector		

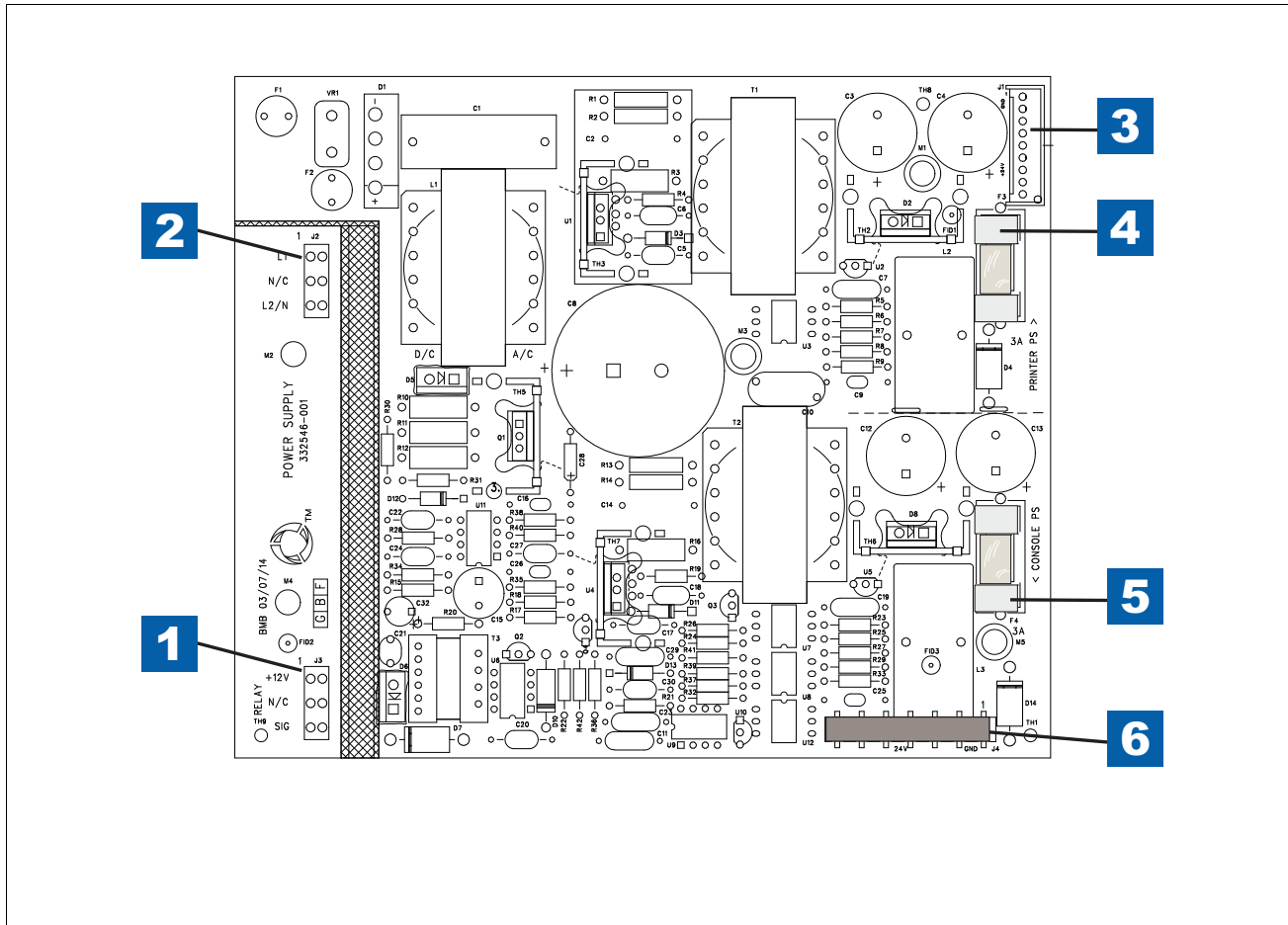

Figure 2-6. Power Supply Board

Legend For Figure 2-6			
Item	Description	Item	Description
1	Low voltage relay control connector (Relay connector on AC input board connects here)	4	Printer power supply fuse, 3A Slo-Blo
2	AC Input power connector (Line AC input connector on AC input board connects here)	5	Console power supply fuse, 3A Slo-Blo
3	Printer power connector J1	6	Power output connector (connects to Comm Backplane board)

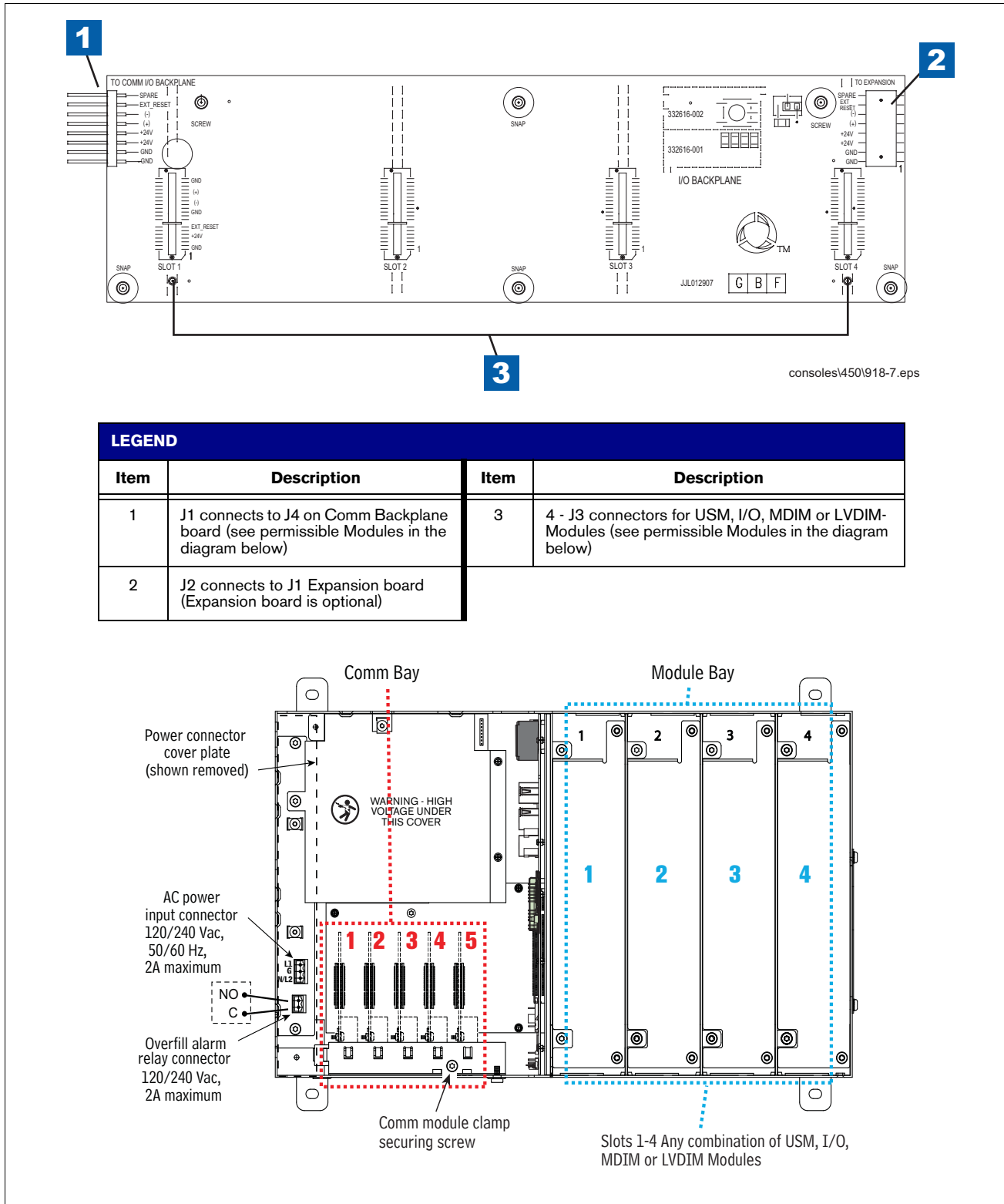

Figure 2-7. I/O Backplane Board

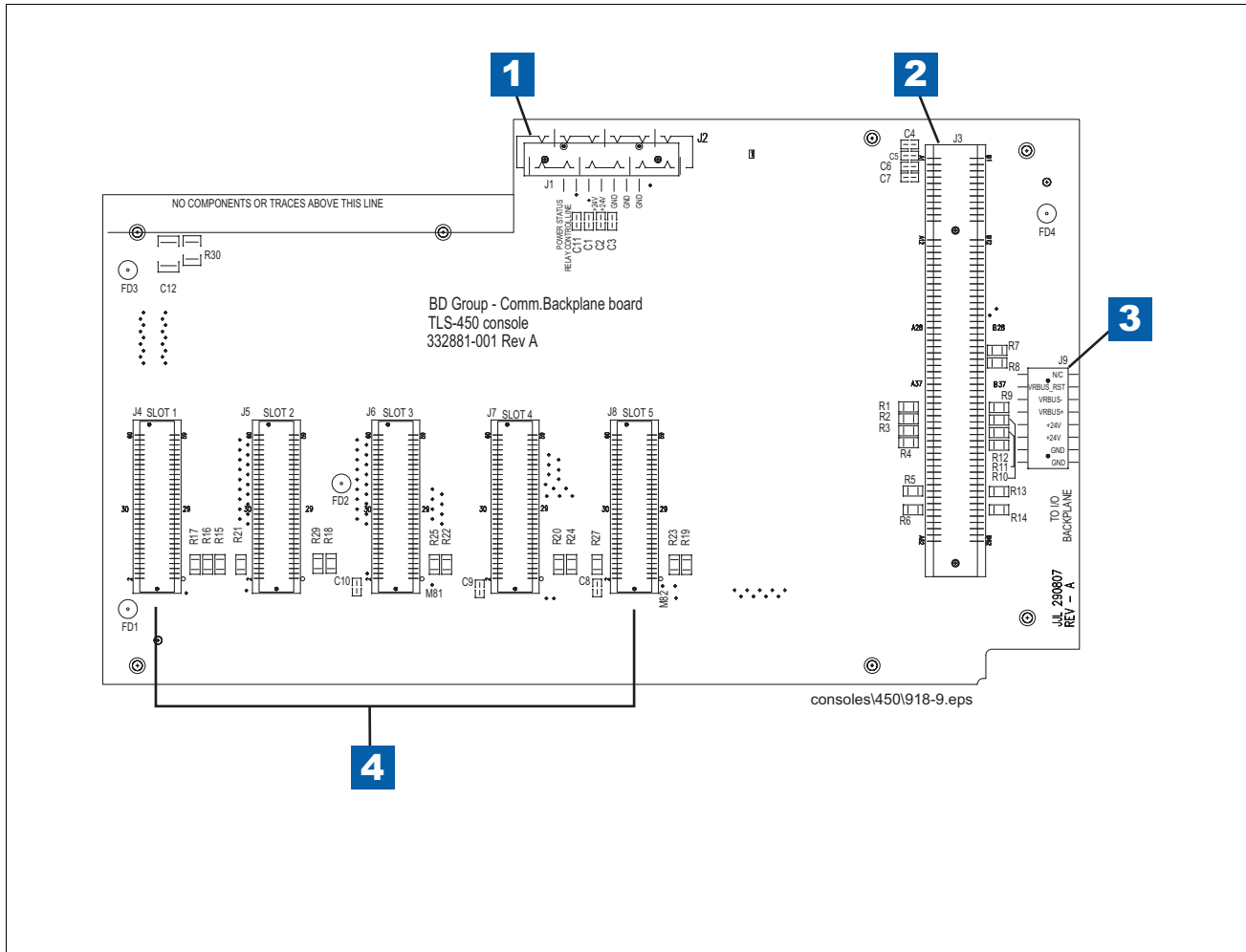

Figure 2-8. Comm Backplane Board

Legend For Figure 2-8			
Item	Description	Item	Description
1	J2 connector connects to J4 on Power Supply board	4	J4 - J8 connectors for optional Comm modules (Comm modules keyed for certain slots) See Figure 2-9 for user selectable Comm Modules. See Table 2-1 for permissible slots/ports for user selectable Comm Modules
2	J3 connector for CPU board		
3	J9 connector connects to J1 connector on I/O Backplane board		See Figure 2-10 for fixed Comm Modules.

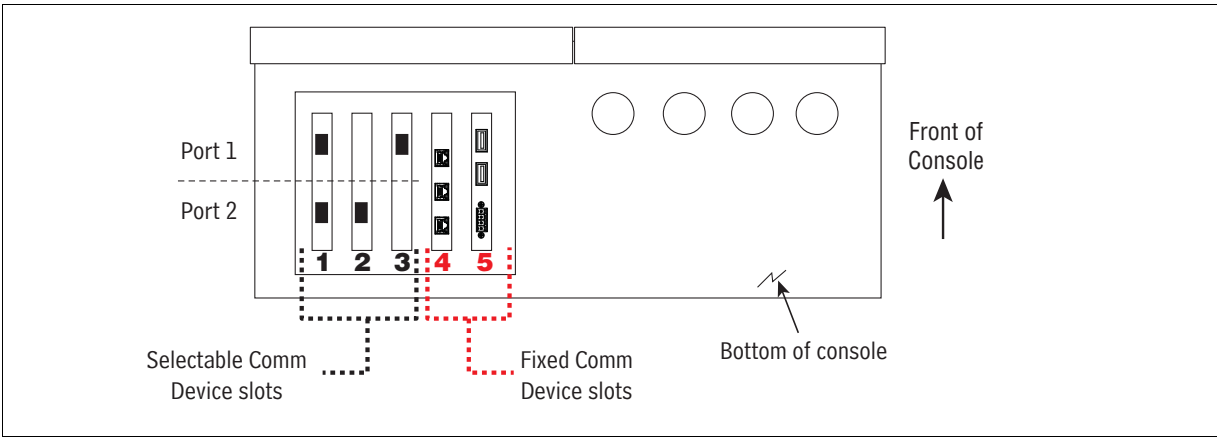

Figure 2-9. TLS-450PLUS Console - Selectable Comm Modules

Table 2-1. Selectable Comm Module Permissible Slots and Port Availability

Comm Module	Comm Type	Slot 1		Slot 2		Slot 3	
		Port		Port		Port	
		1	2	1	2	1	2
RS-232 Single Port (also EDIM, Satellite S-SAT and Satellite H-JBox apps.)	Serial	NC	C	NC	C	NC	C
RS-232 Dual Port (also EDIM, Satellite S-SAT and Satellite H-JBox apps.)		C	C	C	C	NC	C
RS-485 Single Port		NC	C	NC	C	NC	C
RS-485 Dual Port		C	C	C	C	NC	C
RS-232/RS-485 Dual Port		C (RS-232)	C (RS-485)	C (RS-232)	C (RS-485)	NC	C (RS-485)
SiteFax / Modem		NC	C	NC	C	NC	C
CDIM	DIM	C	NC	C	NC	----	----
IFSF LON		C	NC	C	NC	C	NC

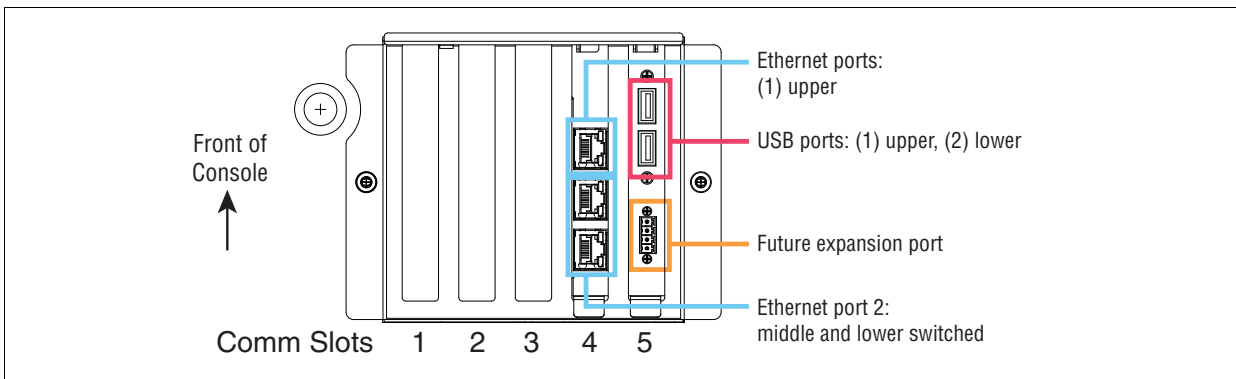

Figure 2-10. TLS-450PLUS Console - Fixed Comm Modules

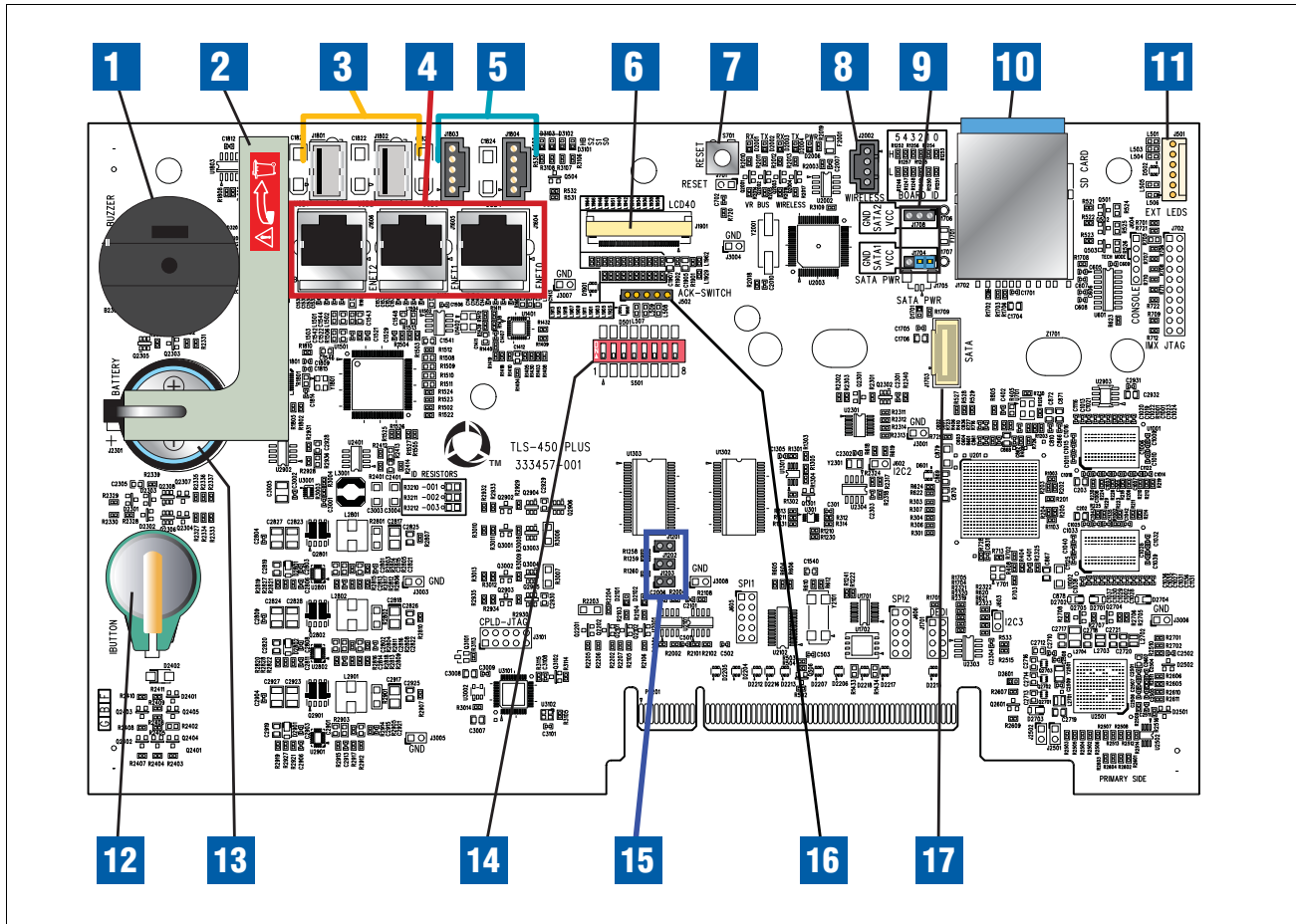

Figure 2-11. CPU Board

LEGEND			
Item	Description	Item	Description
1	Console beeper	10	SD Card (in metal enclosure)
2	Battery isolator strip - to be removed prior to startup	11	LED Backlight cable connector (optional display)
3	USB Type A connectors (2)	12	Features iButton
4	Ethernet (RJ-45) connectors (3)	13	Backup Battery
5	USB (0.1" pitch header) connectors (2)	14	Configuration DIP switches
6	Display cable connector (optional display)	15	SD card/SATA selection jumpers (J1201, J1202 & J1203)
7	Reset button	16	Acknowledge Switch panel cable connector
8	USB module - wireless cable connector	17	SD/SATA board connector
9	SATA Type Jumpers (J1704 & J1708)		

About Screen

The About Screen displays the console's software version and information on installed features. From the Home screen touch **Menu>Overview>About** to view the About screen.

Console Power And Relay Wiring Inputs

Table 2-2 below details TLS-450PLUS power and relay wiring connections and requirements.

Table 2-2. TLS-450PLUS Wiring Inputs

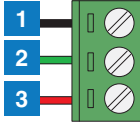
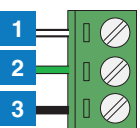
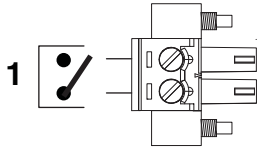
Connector	Description
<p>Input Power</p>	<p>AC power supply:100 to 249Vac, 50/60Hz, 2A maximum 240 Vac input: 1 - N/L2 (black), 2 - Ground (green), 3 - L1 (red)</p>  <p>120 Vac Input: 1 - N/L2 (white), 2 - Ground (green), 3 - L1 (black)</p> 
<p>HV Relay Output</p>	<p>1 relay output: 120/240 Vac, 5A; 30 Vdc, 5A; Fuse ratings 5A, 250 Vac Type T (Slo-BlO)</p> 

Configuration DIP Switch Settings

Verify the Configuration DIP switches (see item 14 in Figure 2-11) are set as shown below:

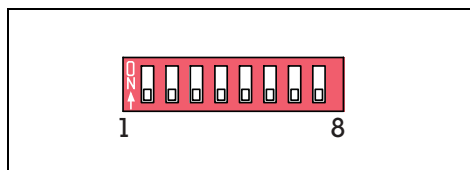

Figure 2-12. Configuration DIP Switch Settings

Basic Troubleshooting Procedures

To ensure proper and safe troubleshooting and repair procedures for the TLS-450PLUS consoles, the following steps should be taken in the order they appear, prior to servicing the system:

1. Review and thoroughly understand the “Safety Warnings” on page 1-2 of this manual.
2. Review the “System Parts Identification” on page 2-1 to locate components.
3. Review “Console Power And Relay Wiring Inputs” to ensure the AC Input board is wired correctly.
4. Review “Configuration DIP Switch Settings” section to ensure the configuration DIP switches are set correctly.
5. Perform a “Intrinsic Safety Check” on page 2-12. If the system fails the Intrinsic Safety Check, turn the AC Power circuit breaker at the service panel to the OFF position, disconnect and cap the AC wires in the monitor, and disconnect and cap all probe and sensor field wires in the probe and sensor junction boxes.
6. Perform the “Visual Inspection of Console Interior” on page 2-13.
7. Refer to the appropriate section of this manual (or another manual, see “Related Manuals” on page 1-1) to troubleshoot a faulty component of the system.

Intrinsic Safety Check



Turn off, tag and lockout power to the console before starting this intrinsic safety check.

Definition of Intrinsic Safety Circuit and System- *An intrinsically safe circuit is one in which any spark or thermal effect is incapable of causing ignition of a mixture of flammable or combustible material in air under prescribed test conditions. An intrinsically safe system is an assembly of interconnected intrinsically safe apparatus, associated apparatus, and interconnecting cables in that those parts of the system that may be used in hazardous (classified) locations are intrinsically safe circuits.

*Excerpt from latest National Electrical Code Handbook.

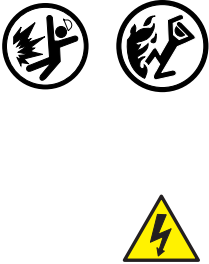
WARNING	
	<p>FAILURE TO COMPLY WITH THE FOLLOWING WARNINGS AND SAFETY PRECAUTIONS COULD CAUSE DAMAGE TO PROPERTY, ENVIRONMENT, RESULTING IN SERIOUS INJURY OR DEATH.</p> <p>Explosion could occur if other wires share conduits or troughs with TLS console intrinsically safe probe, sensor, and thermistor wiring. Conduits and wiring troughs from the console’s probes, sensors, and thermistors must not contain any other wires and must enter the console through their designated preformed knockouts.</p> <p>Improper system operation could result in inaccurate inventory control or undetected potential environmental and health hazards if probe-and sensor-to-monitor wiring runs exceed 1,000 feet. Probe-and sensor-to-monitor wiring runs over 1,000 feet are not UL approved for this application.</p> <p>To avoid electrical shock resulting in personal injury, death, equipment damage or damage to the environment, switch OFF and tag the AC power circuit breaker at the service panel while inspecting, removing, or installing wiring and components.</p>

1. Verify that the TLS console is installed indoors in an accessible location.

2. Verify that the TLS console barrier ground wire to earth ground in the power panel is a #12 AWG (or larger diameter) conductor.
3. Verify that TLS console has chassis ground at AC Input Power connector (see item 3, Figure 2-5).
4. Verify that power conduit and sensor and probe conduits enter TLS console only through preformed, designated knock-outs.
5. Verify that probe and sensor wiring and conduit meet Veeder-Root requirements (ref. manual P/N 577014-073).
6. If the system fails the intrinsic safety check, disconnect and cap the AC wires in the monitor, and disconnect and cap all probe and sensor field wires in the probe and sensor junction boxes.

IMPORTANT! Do not apply power to the system until its installation has been checked and found to be in accordance with the instructions outlined in the Veeder-Root TLS-450PLUS Series Site Prep and Installation manual (P/N 577014-073); the National Electrical Code; federal, state, and local codes; and other applicable safety codes.

Visual Inspection of Console Interior

It is recommended that whenever troubleshooting, repairing, or replacing components, a visual inspection of the overall condition of the system be made.



Turn off, tag and lockout power to the console before starting this inspection.

1. Inspect for signs of corrosion inside the console.
2. Check for broken or frayed insulation on all wires and be sure that the wires are secure at their terminals.
3. Check all PC boards for cracks.
4. Check to see that there is no loose or missing hardware for components (transformers, PC boards, brackets, etc.).
5. Check to ensure that the boot disk (SD Card or SATA drive) is properly installed.
6. Check to see that all interconnecting cable connectors are firmly seated. Check connector ends for cracks and flat cables for breaks.
7. Check fuse continuity and fuseholder contacts for corrosion.
8. Replace all covers after inspection.
9. Check touch screen display for signs of damage.
10. Check the mounting of the equipment to be sure all components were mounted properly and in accordance with instructions contained in the Site Prep and Installation manual.
11. Verify that no unapproved modifications to equipment have been made, no unapproved parts are being used, and previous repairs and modifications bring the unit to original factory condition.
12. All deficiencies should be corrected and damaged components replaced before continuing with procedures.

3 Fuses

The TLS-450PLUS console uses replaceable fuses on several boards and modules. Under no circumstances substitute a different rating or fuse type during service.

Power Supply Fuses

Table 3-1. Power Supply/AC Input board fuses

Fuse	Circuit	Fuse Location	Fuse Size/Type	V-R Part No.
F3	Printer +24V power supply	Fuseholder - Power Supply board	3A/250V Slo-Blo (5 x 20 mm)	576010-942
F4	Console +24V power supply	Fuseholder - Power Supply board	3A/250V Slo-Blo (5 x 20 mm)	576010-942
F1	Relay output	Fuseholder - A/C Input board	2A/250V Slo-Blo (5 x 20 mm)	576010-784

Module Fuses

Table 3-2. I/O Module Fuses

Fuse	Circuit	Fuse Location	Fuse Size/Type	V-R Part No.
F1-F5	F1 - F5 Relay outputs	Fuse holders - I/O module	5A/250V Slo-Blo (5 x 20 mm)	576010-973

4 Diagnostics

The Diagnostic main screen gives you access (depending on installed features) to the site's current and historical tank and line test results. Also from Diagnostic screens, you can manually run tank tests, PLLD line tests and view technical data from monitored devices. Touch the Help button at the top of each diagnostic screen to view more information on each screen's contents.

From the Home Screen, touch **Menu>Diagnostics** to access the Diagnostics Main screen. To access specific diagnostic information for the TLS-450PLUS, touch the desired diagnostic button. An overview of each diagnostic component is discussed in the paragraphs below.

AccuChart

The AccuChart diagnostics contain information on the current and historical tank calibration test results.

AVAILABLE DIAGNOSTIC SCREENS

- **Calibration Feedback** - This screen contains alarms and warnings that are only issued during the automatic AccuChart calibration process.
- **Data Sufficiency** - This screen lets you view an histogram of the data collected at different levels of the tank for the tank's calibration.
- **Delivery Instructions** - This screen contains instructions to help you achieve better calibration data over the range of the tank
- **Error Plot** - This screen lets you view an error plot comparison of two charts using the same data from one tank.
- **Histogram** - This screen lets you view an histogram comparison of two charts using the same data from one tank.
- **Time Ordered Sales** - This report lists all tank sales volume calibrating records applied to two selectable tank charts, over a selectable range, with variances displayed for each chart in adjoining columns.

BIR

The BIR diagnostics contain information on sales, deliveries and inventory levels to allow for reconciliation.

AVAILABLE DIAGNOSTIC SCREENS

- **Reconciliation** - This screen reports metered sales, variance and suggested reasons for the variance for the selected product.
- **Status** - This screen contains a list of causes for Reconciliation events.

LPR Sensor

The LPR (Line Pressure) Sensor diagnostics contain reports on the activity and condition of Line Pressure Sensors.

AVAILABLE LINE PRESSURE SENSOR DIAGNOSTIC REPORTS

- General (general diagnostic information)
- Communication (communication diagnostic information)
- Constants (constants diagnostic information)
- Channel (channel data)

Mag Sensor

The Mag Sensor diagnostics contain reports on the activity and condition of Mag Sensors.

AVAILABLE MAG SENSOR DIAGNOSTIC REPORTS

- General (general diagnostic information)
- Communication (communication diagnostic information)
- Constants (constants diagnostic information)
- Channel (channel data)

Meter

The Meter diagnostics contain information on meter events and enables mapping of a tank to meter.

AVAILABLE DIAGNOSTIC SCREENS

- **Manual Mapping** - The Manual Mapping diagnostic screen will help you assign meters to tanks with small volume dispensing events and to identify post-blend metering. This screen displays active events as they are reported by the POS terminal.
- **Meter Events** - The Meter Events screen lists up to one page of time-ordered meter start/stop events.
- **Tank Map** - This screen displays the meter-to-tank map. This is the screen you want to use to verify meter mapping, or to view if the site should go unmapped, suspending BIR.

Miscellaneous

The Miscellaneous diagnostics contain information on power up and power down events.

AVAILABLE MISCELLANEOUS DIAGNOSTIC REPORTS AND SCREENS

- **Power Reset History Report** - (Power up and power down timestamps).

Module

The Module diagnostics contain information/diagnostics about modules.

AVAILABLE DIAGNOSTIC SCREENS

- **Comm** - This screen contains a report of data transmission and reception results for installed communication modules.
- **Device Assignments** - This screens contains modules, their connected devices and the device's primary and secondary assignments.
- **Device Dir** - This screen lists the console's installed modules and their connected devices.
- **Firmware Upgrade** - This screen lists TLS software available for remote download.
- **HW Configuration** - This screen lists console's module locations and hardware/software details.

PLLD

The PLLD diagnostics provide access to the PLLD Manual Test interface and all PLLD diagnostic reports. Each report has quick access to the PLLD setup screen.

Current or active reports will not be visible for PLLD Lines that are not configured or inactive. Historic reports will be available for PLLD lines even if they are not configured or if they are inactive, as long as they have data to display.

AVAILABLE PLLD DIAGNOSTIC REPORTS AND SCREENS

- 0.1 gph (0.38 lph) Auto-Confirm Report (0.1 gph auto-confirm data)
- 0.1 gph (0.38 lph) Tests Report (0.1 gph diagnostics test results)
- 0.2 gph (0.76 lph) Auto-Confirm Report (0.2 gph auto-confirm data)
- 0.2 gph (0.76 lph) Tests Report (0.2 gph diagnostics test results)
- 3.0 gph (11.3 lph) Tests Report (3.0 gph diagnostics test results)
- Mid-Range Tests Report (mid-range Diagnostics Test Results)
- No-Vent Abort Tests Report (No-Vent Test Aborts Information)
- PLLD Status Report (general status and diagnostic information about PLLD)
- PLLD Manual Test (start or stop PLLD tests manually for one or all lines)
- Pressure Offset Monitor (pressure offset history interface for a pressure offset test)

Probe

The Probe diagnostics contain information/diagnostics about probes. Section 8 of this manual is devoted to probe troubleshooting.

AVAILABLE PROBE DIAGNOSTIC REPORTS AND SCREENS

- **Density Offset** - (current density probe readings and fields to enter tank density and temperature information).
- **Density Offset History** - (density offset history records).
- **Overview**- (general information about each probe).

Relays and Inputs

The Relays and Inputs diagnostics contain information/diagnostics about relays and inputs.

AVAILABLE DIAGNOSTIC SCREENS

- **External Inputs**- View diagnostic information on external Inputs.
- **Relays** - Test all configured relays (except PLLD relays). Two types of relay tests are available:
 - Sequential Test - This test sets selected relays to INACTIVE for two seconds and then sets them to ACTIVE for two seconds. When the test is complete the relays are automatically reset to their original state.
 - Relay Inspection Test - This test sets selected relays to a selectable state, ACTIVE or INACTIVE, until the test is complete. When you finish the test the relays are automatically reset to their original state.

Sensors

The Sensor diagnostics contain reports on the activity and condition of Liquid, Vapor, Groundwater, 2-wire CL and 3-wire CL sensors. Section 9 of this manual is devoted to sensor troubleshooting.

AVAILABLE SENSOR DIAGNOSTIC REPORTS

- Liquid (diagnostic information about each Liquid Sensor)
- Vapor (diagnostic information about each Vapor Sensor)
- Groundwater (diagnostic information about each Groundwater Sensor)
- 2-Wire CL (diagnostic information about each 2-wire CL sensor)
- 3-Wire CL (diagnostic information about each 3-wire CL sensor)

Tank

The Tank diagnostics contains information related to tank inventory volumes and tank charts.

AVAILABLE TANK DIAGNOSTIC REPORTS

- 30 Second Inventory Samples Report (diagnostic information about 30 second inventory samples)

Tank Test

The Tank Test diagnostics contain information on all environmental tank tests. Each report has quick access to the appropriate tank test setup screen. Manual tank leak tests are run from this diagnostic.

CSLD and/or SLD tabs will be displayed only if these features are supported and at least one tank has the respective feature enabled. Current or active reports will not be visible for tanks that are not configured or inactive. Historic reports will be available for tanks even if they are not configured or if they are inactive.

Section 11 of this manual is devoted to CSLD/SLD troubleshooting.

AVAILABLE TANK TEST DIAGNOSTIC REPORTS

- CSLD Monthly Report (CSLD state changes)
- CSLD Rate Table Report (CSLD rate table)
- CSLD Rate Test Report (CSLD rate test results)
- CSLD Test Status Report (current CSLD test status)
- SLD History Report (all SLD test results)
- SLD In-Progress Reports (SLD active tests)
- SLD Last Test Report (most recently completed SLD tests)
- SLD Manual Test Report (manually start or stop an SLD test)

5 Warning and Alarm Messages

The TLS-450PLUS console constantly monitors the entire system for warning and alarm conditions including fuel leaks, inventory limit excesses, and equipment problems. When an alarm occurs, a message displays the device identifier followed by the alarm label.

Device Identifiers

Device Type	Short Device Identifier	Long Device Identifier	Full Device Identifier
Air Flow Meter	Af	AfMeter	Air Flow Meter
Atmospheric Sensor	At	AtmSns	Atmospheric Sensor
Automatic Event	Ae	-----	-----
Contact	Cn	-----	-----
Comm Device	Co	Comm	Comm Device
Dispenser	d	Disp	Dispenser
EDIM,CDIM,LDIM	E	DIM	EDIM,CDIM,LDIM
External Input	I	ExtInp	External Input
Fueling Position	Fp	FPos	Fueling Position
Ground Water Sensor	G	GrndWtr	Ground Water Sensor
Hose	h	Hose	Hose
Hydrocarbon Sensor	Hy	HydcSns	Hydrocarbon Sensor
Line	Ln	Line	Line
Line Pressure Sensor (PLLD)	PI	LPSensr	Line P Sensor
Liquid Sensor	L	Liquid	Liquid Sensor
Mag Sensor	MS	MAG	Mag Sensor
Meter	m	Meter	Meter
MDIM	M	MDIM	MDIM
Module	Mo	Module	Module
PLLD Line	Q	Line	PLLD Line
Probe	Pb	Probe	Probe
Product	F	Product	Product
Pump	Pm	Pump	Pump
Pump Sense Input	S	PumpSns	Pump Sense Input

Device Type	Short Device Identifier	Long Device Identifier	Full Device Identifier
Relay	R	Relay	Relay
Siphon Set	Si	Siphon	Siphon Set
Tank	T	Tank	Tank
Type A (2-Wire CL) Sensor	C	Type A	Type A Sensor
Type B (3-Wire CL) Sensor	H	Type B	Type B Sensor
Vacuum Sensor	Vs	VacSns	Vacuum Sensor
Ullage Pressure Sensor	Pv	UVPSns	Ullage Press Sensor
Vapor Sensor	V	Vapor	Vapor Sensor

Displayed Alarm Messages

A complete list of displayed TLS console alarm messages and a possible cause/action for the alarms are listed in the tables below.

Actual alarms displayed by a particular system depend upon the options installed.

Table 5-1. System Alarms

Alarm	Cause	Action
BIR Daily Close Pending	Tanks are not idle. Dispense or delivery is in progress.	BIR is waiting for an idle period to close the shift report.
BIR Shift Close Pending	Tanks are not idle. Dispense or delivery is in progress.	BIR is waiting for an idle period to close the shift report.
BIR Status Warning	Condition that impacts reconciliation variance identified.	Clears when condition that caused alarm clears; Clears after specified time out; User clears alarm.
System Self Test Error	Contact Technical Support.	Contact Technical Support.
Version Upgrade Available	A new version of the TLS software is available for remote download	Download, Reject or Postpone the software upgrade

Table 5-2. Tank Alarms

Alarm	Cause	Action
AccuChart Calibration Warning	Insufficient data collection rate - Warning will be posted on days that record fewer than 8 transactions.	More dispensing needs to occur.
	Noisy data - Warning will be posted after a calibration is generated, and the RMS Error of the data exceeds a maximum threshold.	Verify Meter Map.
	Data too regionally concentrated - Warning will be posted when there is a severe imbalance in the amount of data collected above and below the mid-height of the tank.	Schedule more deliveries if insufficient data in top half of tank. Schedule fewer deliveries if insufficient data in bottom half of tank.
	Initial tank parameters suspicious - Warning will be posted after a calibration is attempted, but optimization is incomplete.	Manually verify tank diameter, capacity and end shape.
	Station too busy - Warning will be posted on days that record fewer than 2 calibration records.	Temporarily halt dispensing to introduce more idle periods.
	Insufficient Data Collected - Warning will be posted if data sufficiency is too low on the day before end of calibration period.	Extend the calibration period before it expires. Alternatively let the calibration expire and then restart calibration.
Annual Leak Test Fail Alarm	System failed an annual in-tank leak test.	Rerun in-tank leak test. If second test fails, call for service.
Annual Test Needed Alarm	System failed to perform an annual test (0.1 gph [0.38 lph]) in the programmed number of days.	Schedule a 0.1 gph (0.38 lph) test.
Annual Test Needed Warning	System failed to perform an annual test (0.1 gph [0.38 lph]) in the programmed number of days.	Schedule a 0.1 gph (0.38 lph) test.
Cold Temperature Warning	Probe temperature drops below -4°F (-15.6°C).	Probe returns to normal operation after probe temperature rises above 0°F (-17.8°C).
CSLD Rate Increase Warning	An excessive amount of fluid leaked into the tank during a test period.	Call for service following the procedures established for your site.
Delivery Needed Warning	Product level dropped below programmed limit.	Call for a delivery.
Density Warning	The tank density is either greater than the tank density low limit plus 1.00 KG/M ³ (0.062 LBS/FT ³), or is less than the tank density high limit minus 1.00 KG/M ³ (0.062 LBS/FT ³).	Verify fluid density. Retest when product density is within the tank density low and high limits.

Table 5-2. Tank Alarms

Alarm	Cause	Action
Fuel Quality Alarm	Water/phase separation may be present in tank.	Test fuel at bottom of tank to ensure water/phase separation is not present.
Gross Leak Test Fail Alarm	In-tank leak (3.0 gph [11.3 lph]) test failed.	Rerun in-tank leak test. If second test fails, call for service.
High Product Alarm	Product level in tank rose above programmed limit.	Do not allow additional delivery until product is dispensed below preset limit.
High Water Alarm	Water detected in tank exceeds programmed alarm limit.	Remove water from tank.
High Water Warning	Water detected in tank exceeds programmed warning limit.	Remove water from tank.
Invalid Fuel Level Alarm	Product level is too low, causing the fuel and water floats to be too close together.	Call for a delivery.
Leak Alarm	A static in-tank leak test failed. Rerun in-tank leak test.	Rerun in-tank leak test.
Leak Test Active	In-tank leak test is underway.	Do not dispense fuel from this tank until message disappears.
Low Product Alarm	Tank level dropped below the programmed limit.	Call for a delivery.
Maximum Product Alarm	Product level rose above the programmed limit.	Stop delivery. Do not allow additional delivery until product drops below preset limit.
Missing Delivery Ticket Warning	Delivery Ticket information has not been entered at the console.	Enter Delivery Ticket information.
No CSLD Idle Time Warning	System has not had enough idle time over previous 24 hours to run a statistical leak detection test.	Stop dispensing fuel from this tank until CSLD test is complete.
Overfill Alarm	Fuel level has exceeded a programmed limit. Potential overflow of tank may occur.	Stop delivery. Check for spillage.
Periodic Leak Test Fail Alarm	In-tank leak (0.2 gph [0.76 lph]) test failed. Dispensing halts if programmed to do so.	Rerun in-tank leak test. If second test fails, call for service.
Periodic Test Needed Alarm	A periodic in-tank leak (0.2 gph [0.76 lph]) test has not been successfully completed within the programmed number of days.	Schedule a 0.2 gph (0.76 lph) test.
Periodic Test Needed Warning	A periodic in-tank leak (0.2 gph [0.76 lph]) test has not been successfully completed within the programmed number of days.	Schedule a 0.2 gph (0.76 lph) test.
Probe Out Alarm	Hardware failure - probe or interconnecting wiring to console.	Call for service following the procedures established for your site.
Setup Data Warning	Device setup data problem.	Recheck device setup parameters.

Table 5-2. Tank Alarms

Alarm	Cause	Action
Siphon Break Active Warning	Siphon break valve has shut down manifold for tank test.	Clears when tank test completes.
Sudden Loss Alarm	System detects loss of fuel during an idle period.	Check for gross leak.
Tank/Line Gross Leak Alarm	In-tank gross leak test failed. A static in-tank leak test failed	Call for service following the procedures established for your site.

Table 5-3. Liquid Sensor Alarms

Alarm	Cause	Action
Fuel Alarm	Fuel is present in the area being monitored by the sensor.	Call for service following the procedures established for your site.
High Liquid Alarm	Dispenser Pan/Containment Sump Sensor Liquid reached 8" (203mm) on the dispenser pan sensor or 10" (254mm) on the containment sump sensor.	Immediately follow the alarm reporting procedures established for your site.
	Dual Float Differentiating Hydrostatic Sensor A sensor in a brine-filled interstice detects an increase in the brine level increase. Liquid is entering the riser pipe, or in a high groundwater area, an outer wall rupture has occurred.	Call for service following the procedures established for your site.
Liquid Warning	Liquid reached 1 inch (25.4 mm) on the dispenser pan or containment sump sensor.	Immediately follow the alarm reporting procedures established for your site.
Low Liquid Alarm	The sensor in a brine-filled interstice detects a decrease in the brine level. A hole is in the tank's inner wall, or in low groundwater areas, a hole is in the outer wall.	Call for service following the procedures established for your site.
Out Alarm	The sensor setup was performed incorrectly or a sensor is disconnected or is not functioning properly.	Call for service following the procedures established for your site.
Setup Data Warning	Device setup data problem.	Recheck device setup parameters.
Short Alarm	A short has occurred in the sensor wiring or in the sensor.	Call for service following the procedures established for your site.
Water Alarm	Sensor has detected water.	Call for service following the procedures established for your site.
Water Out Alarm	Water level is below the float switch making the sensor ineffective.	Call for service following the procedures established for your site.

Table 5-4. Vapor Sensor Alarms

Alarm	Cause	Action
Fuel Alarm	Fuel is present in the area being monitored by the sensor.	Call for service following the procedures established for your site.
Out Alarm	The sensor setup was performed incorrectly or a sensor is disconnected or is not functioning properly.	Call for service following the procedures established for your site.
Setup Data Warning	Device setup data problem.	Recheck device setup parameters.
Short Alarm	A short has occurred in the sensor wiring or in the sensor.	Call for service following the procedures established for your site.
Water Alarm	The vapor sensor is immersed in water and is incapable of detecting fuel vapors.	Call for service following the procedures established for your site.

Table 5-5. External Input Alarms

Alarm	Cause	Action
Generator Off	Backup generator shut down, in-tank leak testing resumed.	None
Generator On	Backup generator switched on, in-tank leak testing halted.	None
Input Alarm	External device changed from programmed condition.	Check the operation of the external device.
Input Normal	(Not displayed, printed out only) External device returned to preset condition.	None
Input Out Alarm	No longer receiving data from input. Hardware or setup problem.	Call for service following the procedures established for your site.
Setup Data Warning	Device setup data problem.	Recheck device setup parameters.

Table 5-6. Groundwater Sensor Alarms

Alarm	Cause	Action
Fuel Alarm	Fuel is present in the area being monitored by the sensor.	Call for service following the procedures established for your site.
Out Alarm	The sensor setup was performed incorrectly or a sensor is disconnected or is not functioning properly.	Call for service following the procedures established for your site.
Setup Data Warning	Device setup data problem.	Recheck device setup parameters.

Table 5-6. Groundwater Sensor Alarms

Alarm	Cause	Action
Short Alarm	A short has occurred in the sensor wiring or in the sensor.	Call for service following the procedures established for your site.
Water Out Alarm	Water level is below the float switch making the groundwater sensor ineffective.	Call for service following the procedures established for your site.

Table 5-7. Type A Sensor Alarms

Alarm	Cause	Action
Fuel Alarm	Fuel is present in the area being monitored by the sensor.	Call for service following the procedures established for your site.
Out Alarm	The sensor setup was performed incorrectly or a sensor is disconnected or is not functioning properly.	Call for service following the procedures established for your site.
Short Alarm	A short has occurred in the sensor wiring or in the sensor.	Call for service following the procedures established for your site.
Setup Data Warning	Device setup data problem.	Recheck device setup parameters.
Water Alarm	Water is present in the area being monitored by the sensor.	Call for service following the procedures established for your site.

Table 5-8. Type B Sensor Alarms

Alarm	Cause	Action
Fuel Alarm	Fuel is present in the area being monitored by the sensor.	Call for service following the procedures established for your site.
High Liquid Alarm	The sensor detects a high liquid level.	Call for service following the procedures established for your site.
Liquid Warning	Liquid reached 1 inch (25.4 mm) on the dispenser pan or containment sump sensors.	Immediately follow the alarm reporting procedures established for your site.
Out Alarm	The sensor setup was performed incorrectly or a sensor is disconnected or is not functioning properly.	Call for service following the procedures established for your site.
Setup Data Warning	Device setup data problem.	Recheck device setup parameters.
Short Alarm	A short has occurred in the sensor wiring or in the sensor.	Call for service following the procedures established for your site.

Table 5-9. Relay Alarms

Alarm	Cause	Action
Out Alarm	Console has lost communication with the relay.	Call for service following the procedures established for your site.
Setup Data Warning	Device setup data problem.	Recheck device setup parameters.

Table 5-10. Pressure Line Leak Alarms

Alarm	Cause	Action
Annual Test Fail Alarm	0.1 gph (0.38 lph) line test failure. Dispensing halts, if programmed to do so.	Consult PLLD Alarm Quick Help Guide and PLLD diagnostic screens.
Annual Test Needed Alarm	System failed to perform an annual test (0.1 gph [0.38 lph]) in the programmed number of days.	Schedule a 0.1 gph (0.38 lph) test.
Annual Test Needed Warning	System failed to perform an annual test (0.1 gph [0.38 lph]) in the programmed number of days.	Schedule a 0.1 gph (0.38 lph) test.
Continuous Handle On Alarm	Handle signal has been active for a programmed number of hours.	Call for service following the procedures established for your site.
Fuel Out Alarm	Tank product level below 10-inch (25.4 cm) level - cannot pump when active.	Schedule a delivery.
Gross Test Fail Alarm	3 gph (11.3 lph) line test failure. Dispensing halts, if programmed to do so, while the alarm is active.	Consult PLLD Alarm Quick Help Guide and PLLD diagnostic screens.
Line Equipment Alarm	A problem with the pressure measurement equipment has been detected.	Call for service following the procedures established for your site.
Low Pressure Alarm	Low pump dispense pressure is detected during a dispense. Dispensing halts if programmed to do so.	The next handle up will restart the pump.
Periodic Test Fail Alarm	0.2 gph (0.76 lph) test failure. Dispensing halts, if programmed to do so.	Consult PLLD Alarm Quick Help Guide and PLLD diagnostic screens.
Periodic Test Needed Alarm	A periodic in-tank leak (0.2 gph [0.76 lph]) test has not been successfully completed within the programmed number of days.	Schedule a 0.2 gph (0.76 lph) test.
Periodic Test Needed Warning	A periodic in-tank leak (0.2 gph [0.76 lph]) test has not been successfully completed within the programmed number of days.	Schedule a 0.2 gph (0.76 lph) test.
Setup Data Warning	The default line length was not changed to reflect the actual line length.	Enter the correct line length(s).
Sensor Open Alarm	Pressure sensor reading is less than -8 psi (-51.2 kPa). Only tested while the pump is running. Dispensing halts if programmed to do so.	3 gph (11.3 lph) test must pass to clear the alarm. Call for service following the procedures established for your site.

Table 5-10. Pressure Line Leak Alarms

Alarm	Cause	Action
Shutdown Alarm	System shut down line because of failed line leak test, or an alarm assigned to disable the line is active.	Identify offending alarm, and refer to PLLD alarms for corrective action.

Table 5-11. Mag Sensor Alarms

Alarm	Cause	Action
Communication Alarm	Hardware failure - sensor or interconnecting wiring to console.	Call for service following the procedures established for your site.
Fault Alarm	Monitored parameter exceeded preset threshold.	Call for service following the procedures established for your site.
Fuel Alarm	Monitored parameter exceeded preset threshold.	Call for service following the procedures established for your site.
Fuel Warning	Monitored parameter exceeded preset threshold.	Call for service following the procedures established for your site.
High Liquid Alarm	Monitored parameter exceeded preset threshold.	Call for service following the procedures established for your site.
High Liquid Warning	Monitored parameter exceeded preset threshold.	Call for service following the procedures established for your site.
Install Alarm	Sensor not installed in correct position.	Call for service following the procedures established for your site.
Low Liquid Alarm	Monitored parameter exceeded preset threshold.	Call for service following the procedures established for your site.
Low Liquid Warning	Monitored parameter exceeded preset threshold.	Call for service following the procedures established for your site.
Relay Active	Monitored parameter exceeded preset threshold.	Call for service following the procedures established for your site.
Setup Data Warning	Device setup data problem.	Recheck device setup parameters.
Temperature Warning	Ambient temperature exceeded sensor's operating range (-40 to +122°F [-40 to +50°C]).	Warning removed when temperature returns to within sensor's operating range.
Water Alarm	Monitored parameter exceeded preset threshold.	Call for service following the procedures established for your site.
Water Warning	Monitored parameter exceeded preset threshold.	Call for service following the procedures established for your site.

Table 5-12. Line Pressure Sensor Alarms

Alarm	Cause	Action
Communication Alarm	Console has lost communication with the relay.	Call for service following the procedures established for your site.
Setup Data Warning	Device setup data problem.	Recheck device setup parameters.

Table 5-13. Printer Alarms

Alarm	Cause	Action
Printer Error	Printer feed roller release is open.	Push the release lever to the up position.
Printer out of Paper	Paper roll is empty.	Replace the paper roll with Veeder-Root part number 514100-456 only.

Table 5-14. Pump Alarms

Alarm	Cause	Action
Pump Out Alarm	Hardware failure or setup data warning on dependent device (Relay or External Input) prevents this device from working.	Call for service following the procedures established for your site.
Setup Data Warning	Device setup data problem.	Recheck device setup parameters.

Table 5-15. Line Alarms

Alarm	Cause	Action
Line Out Alarm	Hardware failure or setup data warning on dependent device (Pump) prevents this device from working.	Call for service following the procedures established for your site.
Line Setup Data Warning	Device setup data problem.	Recheck device setup parameters.

Table 5-16. Communication Alarms

Alarm	Cause	Action
Setup Data Alarm	Hardware failure or setup data warning on dependent device (Pump) prevents this device from working.	Call for service following the procedures established for your site.
Setup Data Warning	Device setup data problem.	Recheck device setup parameters.

Table 5-17. Contact Alarms

Alarm	Cause	Action
Autodial Failed Alarm	System failed to connect to a remote receiver after 'n' tries.	Verify the address book settings for the contact are correct (i.e., modem device number, phone number to dial), verify the receiving device (fax or modem) is operational. Contact technical support for assistance.
Autodial Setup Data Warning	Device setup data problem	Recheck device setup parameters.
Email Failed	The console did not successfully send email when configured to email.	Verify the address book settings for the contact are correct (email address of recipient), verify network connectivity is available (Ethernet card is installed). Contact technical support for assistance.
Fax Failed	The console did not successfully send fax when configured to fax.	Verify the address book settings for the contact are correct (fax address of recipient), verify modem is configured. Contact technical support for assistance.

Table 5-18. Auto Events Alarms

Alarm	Cause	Action
Setup Data Warning	Device setup data problem	Recheck device setup parameters.

Table 5-19. Product Alarms

Alarm	Cause	Action
Product Setup Warning	Setup is incomplete or in error.	Meter Data Present not setup. Temperature Compensation not setup. BIR Alarm Threshold and/or Alarm Offset values incorrect.
Product Threshold Alarm	Periodic variance exceeds threshold.	The periodic variance of a product exceeded the BIR calculated threshold.

Table 5-20. DIM Alarms





Alarm	Cause	Action
Communication Failure Alarm	DIM module has stopped communicating with the external equipment or the cable adaptor box.	Reconnect the external equipment or adaptor box to the TLS.
Disabled DIM	DIM module has stopped communicating with central processing unit of the console.	Verify DIM firmware is correct. Replace DIM module.
Setup Data Warning	Device setup data problem	Recheck device setup parameters.

6 Console Troubleshooting

Boot-Up LED Sequence

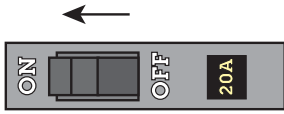
A normal TLS-450PLUS boot-up sequence can be followed observing the front panel status LEDs as described in Table 6-1.

Table 6-1. Front Panel LED Normal Boot-Up Sequence

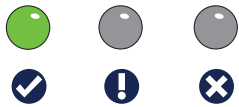
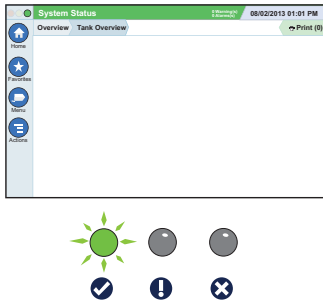
Boot-Up Sequence	Visual Sequence	System Task
1. Console powered On at the breaker.		
2. All three LEDs On.		Console is loading U-Boot.
3. The Green LED is On, the rest are Off.		U-Boot is loading the Operating System (OS).
4. All three LEDs On.		Linux is loaded and starts the drivers for USB, Ethernet, etc.
5. The Green LED is On, the rest are Off.		Linux is running and the system is being initialized.
6. Green LED On Steady and the designated Home screen displays (when equipped with a touch screen display).		The console completes the boot-up sequence, starts the applications and brings up the GUI, or is ready for use.

TLS-450PLUS Troubleshooting Guide

Table 6-2. TLS-450PLUS Troubleshooting

Symptom	Cause	Corrective Action
Blank printout from integral printer	Wrong paper type - not thermal paper.	Replace with thermal paper roll (Veeder-Root Part No. 514100-328).
	Printer paper in backwards.	<p>Install paper properly. Swing down the printer cover (1) and push the paper feed release lever (2) down. Remove the roll of paper.</p> <p>Insert the roll into the paper tray with the end of the paper tail facing you from the bottom of the roll. Pull the tail out and push the tail under the black paper feed roller until it exits above the feed roller (3). Push lever (2) up.</p> <p>Touch the print button  to advance the paper a few lines and verify the paper is feeding correctly. Close the printer cover.</p> 
	Paper roll release lever not closed.	Close lever.
	Defective printer.	Replace printer door.
Characters "Overprint"	Paper jam.	Remove paper jam and replace paper.
	Paper roll release lever not closed.	Close lever.
	Defective printer.	Replace printer door.
Missing characters on printout	Defective printer.	Replace printer door.

Table 6-2. TLS-450PLUS Troubleshooting

Symptom	Cause	Corrective Action
No display reading	No AC power to monitor.	Verify power circuit breaker is switched ON Ensure power cable is properly secured to AC Input Power connector (item 3, Figure 2-5).
	AC fuse blown.	Check fuses on AC Input module and Power Supply board.
	Defective power supply.	Replace Power Supply board.
	Defective display board.	Replace display door.
Printer will not print or feed paper	Printer Error Alarm - Printer Traction lever in down position.	Raise printer traction lever to up position.
	Printer out of paper.	Load thermal paper (Veeder-Root Part No. 514100-328).
	Loose printer cable.	Check connections between printer and CPU board.
	Defective printer.	Replace printer door.
	Defective printer communication module.	
System will not communicate via fax.	Incorrect or defective interconnect cable.	Check cable between TLS and telephone jack.
	Problem with telephone line.	Call phone company.
	Incorrect modem baud rate, parity, data bits, or stop bit settings.	Set all to agree with host device. Recheck device setup parameters.
	Defective modem card.	Replace modem.
System will not communicate via RS-232 Module	Incorrect cable.	Use null cable when connecting to terminal/ computer. Use straight cable when connected to external modem.
	Incorrect modem baud rate, parity, data bits, or stop bit settings.	Set all to agree with host device. Recheck device setup parameters.
	Defective RS-232 Module.	Replace module.
	Defective host terminal or modem.	See manufacturer's troubleshooting manual.

Table 6-2. TLS-450PLUS Troubleshooting

Symptom	Cause	Corrective Action
Boot Sequence Stalled	Boot device jumper(s) in wrong position(s).	Verify jumper positions. For SD card: on J1203, off J1201 and J1202. For SATA drive: on J1201 and J1202, off J1203.
	The console cannot read the SD Card, is not able to read the RAM, or the SD Card is missing.	<ol style="list-style-type: none"> 1. Open the console's printer and display cover following as described in Step 1 of "Removing The Ack Switch Panel/Display (Right) Door And CPU Board" on page 7-3. 2. Confirm SD is present (Item 10 in Figure 2-11 on page 2-10) - if not, order SD card. If present continue to next step. 3. Remove the SD Card by pushing in on the SD Card then quickly releasing it letting it spring free of its enclosure's latch so you can slide it out. While you have the SD Card out, check the position of the write protect slide on the side of the SD Card, making sure it is in the position shown below and then reinsert it in its enclosure until it clicks into the enclosure's latch: 
Console Does Not Power On	AC Power Input connector (Item 3, Figure 2-5) is loose.	Verify AC Power Input connector is fully seated in its connector.
	The wires in the power input plug are pinched underneath the terminal's screws.	Verify each of the wires is correctly seated in each of the plug's terminal clamps. If the clamps are not opened all the way when inserting the wires into the plug, the wires can be inserted behind the clamps preventing proper contact.
	Wires to the power input plug are attached to the wrong power input terminals.	Verify correct wiring.
	Fuse missing or blown.	Check F4 fuse (Item 5 in Figure 2-6).
	Power supply board bad.	Replace Power supply board.
	AC input board bad.	Replace AC input board.
	CPU board bad.	Replace CPU board.
	Comm backplane board bad.	Replace Comm backplane board.
I/O backplane board bad.	Replace I/O backplane board.	

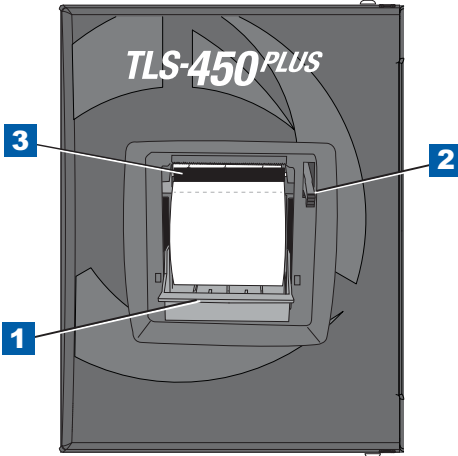
Table 6-2. TLS-450PLUS Troubleshooting

Symptom	Cause	Corrective Action
Display Dark After Boot-Up	Bad Display cable, loose Display cable.	<p>1. Open the printer door.</p> <p>2. Verify the Display ribbon cable (Item 3 in Figure 2-3 on page 2-3) is securely seated in its CPU board connector and that the locking latch (1 pointer) is down against the cable. If inserted fully, the blue end of the cable will be no more than 1/16" (2mm) out of the connector as shown below:</p>  <p>3. If the cable appears loose or out of the connector, rotate the locking member of the cable connector (1 pointer) up 90° from the connector's fixed base (2 pointer). Reseat the cable end into the connector as far as it will go and then push the locking member down onto the connector snapping it in place.</p>
	Bad SD card.	Replace SD card.
	Bad CPU board.	Replace CPU board.
Acknowledge (Ack) Switch Not Working Properly	The Ack cable plug is loose or not plugged in Ack connector.	Reseat cable connector.
	Ack cable is broken.	Replace the Ack assembly.
	Ack cable connector incorrectly installed.	Verify all pins of Ack cable plug are seated in the Ack switch connector, J502.
	Bad SD card.	Replace SD card.
	Bad CPU board.	Replace CPU board.
RS-232 Communication Not Working	Serial settings are incorrect for data transfer such as Baud Rate, Parity Setting, Data Bit, and Flow Control.	Verify serial communication settings to make sure settings are correct for data transfer.
	Bad cable connecting TLS-450PLUS to serial device.	Verify if cable is bad.
	Polarity of wiring is wrong.	Verify wiring polarity.
	Bad RS-232 comm module.	Replace RS-232 comm module.
	Bad comm backplane.	Replace comm backplane.

Table 6-2. TLS-450PLUS Troubleshooting

Symptom	Cause	Corrective Action							
RS-485 Communication Not Working	Serial settings are incorrect for data transfer such as Baud Rate, Parity Setting, Data Bit, and Flow Control.	Verify serial communication settings to make sure settings are correct for data transfer.							
	Bad cable connecting TLS-450PLUS to serial device.	Verify if cable is bad.							
	Polarity of wiring is wrong.	Verify wiring polarity.							
	Bad RS-485 comm module.	Replace RS-485 comm module.							
	Bad comm backplane.	Replace comm backplane.							
IFSF Communication Not Working	Verify LON Card selected for device field on IFSF Communication Setup screen.	Not selected - Correct device selection							
		Selected - Go to next cause.							
	No Communication	<p>Verify Node ID and IFSF messages displayed in Diagnostic Module IFSF screen:</p> <p>On the front panel screen touch Menu>Diagnostics>Module>IFSF:. This screen allows you to view messages for the Node ID so you can validate IFSF communications. The messages (Data) are listed in descending order with the latest message at the top (see example below).</p>  <table border="1"> <thead> <tr> <th>TIME</th> <th>DATA</th> </tr> </thead> <tbody> <tr> <td>DEC 3, 2015 8:45:03 AM</td> <td>30300906020602801B0003010106</td> </tr> <tr> <td>DEC 3, 2015 8:45:02 AM</td> <td>30300906020602801B0003010002</td> </tr> <tr> <td>DEC 3, 2015 8:45:01 AM</td> <td>3030090206020080400006010003020202</td> </tr> </tbody> </table>	TIME	DATA	DEC 3, 2015 8:45:03 AM	30300906020602801B0003010106	DEC 3, 2015 8:45:02 AM	30300906020602801B0003010002	DEC 3, 2015 8:45:01 AM
TIME	DATA								
DEC 3, 2015 8:45:03 AM	30300906020602801B0003010106								
DEC 3, 2015 8:45:02 AM	30300906020602801B0003010002								
DEC 3, 2015 8:45:01 AM	3030090206020080400006010003020202								
	No messages have been received - Go to next cause								
	Messages have been received - Done								

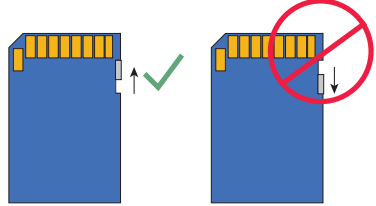
Table 6-2. TLS-450PLUS Troubleshooting

Symptom	Cause	Corrective Action																																																																																																					
IFSF Communication Not Working - (cont'd.)	Node ID Setting Incorrect	<p>Get the correct Node ID setting from the site's LON administrator and verify that the correct Node ID has been entered:</p> <ol style="list-style-type: none"> Shut off power to the console. Remove the two T15 Torx screws securing the left door of the console (item 2 in Figure 2-1 on page 2-1) and open the left door. Locate the Node ID and Termination DIP switches on the IFSF LON module (comm slots 1,2, or 3):  <ol style="list-style-type: none"> The Termination DIP switches are set in the NO TERMINATION or all the way to the right in the image above). The Node ID DIP switches are set to a value supplied by the Site IFSF LON Administrator. LON Node Address is subnet 9, Node X, where X is selected using DIP switches 1-4 using the legend below: <table border="1" data-bbox="885 1270 1429 1396"> <thead> <tr> <th rowspan="2">DIP SW</th> <th colspan="16">Node Address</th> </tr> <tr> <th>1</th><th>2</th><th>3</th><th>4</th><th>5</th><th>6</th><th>7</th><th>8</th><th>9</th><th>10</th><th>11</th><th>12</th><th>13</th><th>14</th><th>15</th><th>16</th> </tr> </thead> <tbody> <tr> <td>1</td> <td></td><td>L</td><td>L</td><td>L</td><td>L</td><td>L</td><td>L</td><td>L</td><td>L</td><td>L</td><td>L</td><td>L</td><td>L</td><td>L</td><td>L</td><td>L</td> </tr> <tr> <td>2</td> <td></td><td></td><td>L</td><td>L</td><td></td><td></td><td>L</td><td>L</td><td></td><td>L</td><td>L</td><td></td><td>L</td><td>L</td><td>L</td><td>L</td> </tr> <tr> <td>3</td> <td></td><td></td><td></td><td></td><td>L</td><td>L</td><td>L</td><td>L</td><td></td><td></td><td></td><td></td><td>L</td><td>L</td><td>L</td><td>L</td> </tr> <tr> <td>4</td> <td></td><td></td><td></td><td></td><td></td><td></td><td></td><td>L</td><td>L</td><td>L</td><td>L</td><td>L</td><td>L</td><td>L</td><td>L</td><td>L</td> </tr> </tbody> </table> <p>L (Slide to Left) = ON, Blank = Slide to Right</p> <p><i>Note: The Node ID DIP switches shown in the example illustration above are set to Node 11.</i></p> <ol style="list-style-type: none"> Close the console door and reapply power. IFSF communication still not working - go to next cause. 	DIP SW	Node Address																1	2	3	4	5	6	7	8	9	10	11	12	13	14	15	16	1		L	L	L	L	L	L	L	L	L	L	L	L	L	L	L	2			L	L			L	L		L	L		L	L	L	L	3					L	L	L	L					L	L	L	L	4								L	L	L	L	L	L	L	L	L
	DIP SW	Node Address																																																																																																					
1		2	3	4	5	6	7	8	9	10	11	12	13	14	15	16																																																																																							
1		L	L	L	L	L	L	L	L	L	L	L	L	L	L	L																																																																																							
2			L	L			L	L		L	L		L	L	L	L																																																																																							
3					L	L	L	L					L	L	L	L																																																																																							
4								L	L	L	L	L	L	L	L	L																																																																																							
	Intermittent communication	<p>Verify Termination DIP switches are set for No Termination. Follow the procedure in cause above to access Termination DIP switches and verify both DIP switches are all the way to the right (No Termination). Verify Termination in site's Primary Junction Box. IFSF communication still not working - go to next cause.</p>																																																																																																					

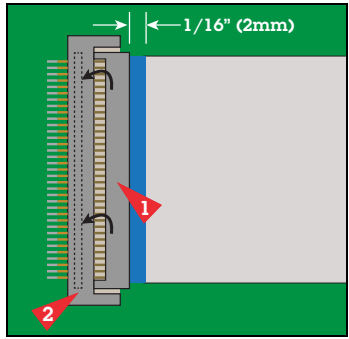
Table 6-2. TLS-450PLUS Troubleshooting

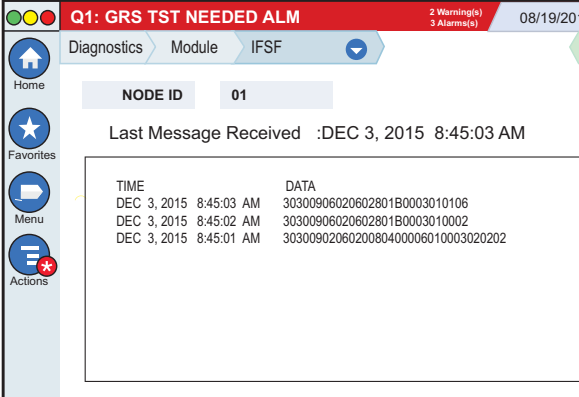

Symptom	Cause	Corrective Action
<p>IFSF Communication Not Working - (cont'd.)</p>	<p>Bad cable connecting ATG to LON network</p>	<p>Verify the external input plug is pushed all the way into the connector on the IFSF module. Verify if wires are loose or broken. If necessary, replace cable. The IFSF cable's plug will have to be assembled in the field as shown below:</p>
<div style="border: 1px solid black; padding: 10px;"> <div style="display: flex; justify-content: space-around; align-items: center;"> <div style="text-align: center;">  </div> <div style="text-align: center;">  </div> <div style="font-size: small;"> <p>Verify each of the wires is correctly seated in the plug's terminal clamps. If the clamps are not opened all the way when inserting the wires into the plug, the wires can be inserted behind the clamps preventing proper contact.</p> </div> </div> <div style="margin-top: 20px;">  <p>2-pin IFSF plug with cable standoff and two small slots for Tie Wrap</p> <p>2 conductor LON cable supplied by customer</p> <p>Housing</p> <p>Cable</p> <p>Tie wrap</p> <p>A - A</p> <p>From the outside of the housing piece thread tie wrap up through one of the small slots in the plug body, around the LON cable and back out through second slot. Push tie wrap through self-locking head and pull tight to secure cable against cable standoff.</p> <p>Cover snaps onto plug enclosing connections</p> </div> </div>		

Table 6-2. TLS-450PLUS Troubleshooting

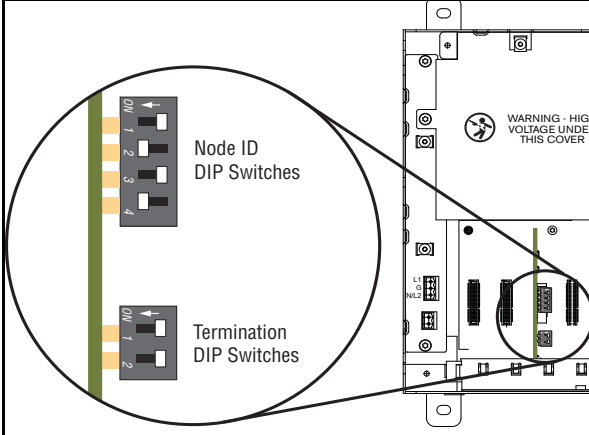
Symptom	Cause	Corrective Action
No Connection To Ethernet Port	Cable is plugged into the wrong port.	Verify Ethernet cables are plugged into correct port(s) on the bottom of the console (ref. Slot 4 in Figure 2-10 on page 2-9).
	Cable is not properly connected to CPU board.	Open Printer door. Verify that the Slot 4 Ethernet Interface module cables are properly connected to the CPU board connectors: 
	Ethernet communication settings, such as, IP Address type, IP Address, etc.	<ol style="list-style-type: none"> 1. Verify Ethernet communication settings are correct. 2. Check if Ethernet port's Link and Activities LEDs are flashing:  3. Try to communicate to the maintenance IP address: 169.254.21.12
	Bad cable.	Verify if cable is bad.
	Defective Ethernet signal source.	Verify Ethernet signal source, e.g. hub or switch.
Bad Ethernet comm module.	Replace Ethernet Interface module.	
Bad CPU board.	Replace CPU board.	

Table 6-2. TLS-450PLUS Troubleshooting

Symptom	Cause	Corrective Action
USB communication not working	Cable(s) not properly plugged into port on USB module.	Verify cables are plugged into moduled properly (ref. Slot 5 in Figure 2-10).
	Cable(s) not properly plugged into connectors on CPU board.	Open Printer door. Verify that the Slot 5 USB module cables are properly connected to the CPU board USB connectors 3 and 4: 
Probe Connected To TLS-450PLUS But No Probe Address Under Devices Menu	Probe wires were connected while the console was ON.	Re-boot console.
	Probe wiring installed incorrectly.	1. Open the Display door. 2. Polarity is required for this device. Locate the questionable probe's input wiring connections at the USM connector (Figure 2-7 on page 2-7). Verify the two wires are connected with white to + terminal and black to - terminal. 3. Verify each of the wires is correctly seated in each of the plug's terminal clamps. If the clamps are not opened all the way when inserting the wires into the plug, the wires can be inserted behind the clamps preventing proper contact: 
	Probe input in USM or bad probe.	Verify by connecting probe to a different input on the USM module. See Section 9 (Probe Troubleshooting).
	Bad USM module.	Replace USM module.

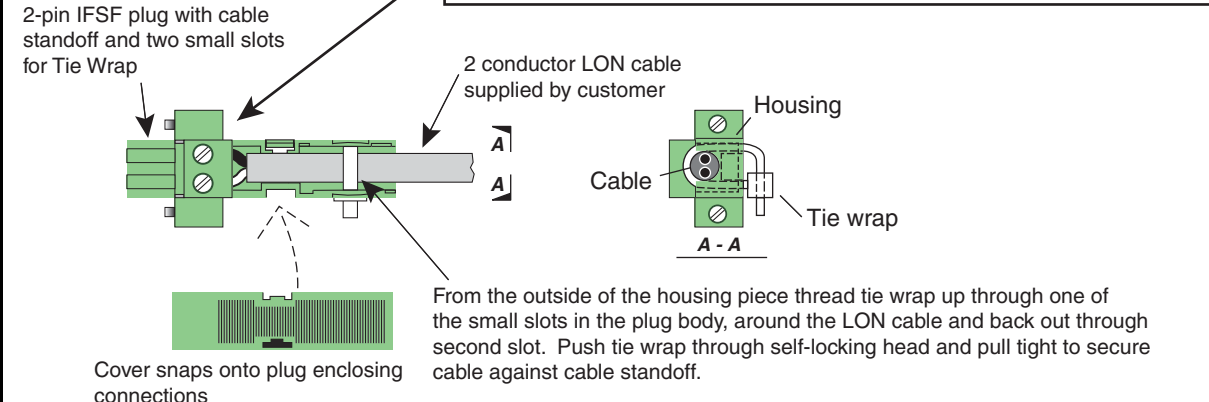
Table 6-2. TLS-450PLUS Troubleshooting

Symptom	Cause	Corrective Action
Incorrect Time Displayed After Console Power Loss	Battery Isolator strip not removed.	Remove and discard the battery isolator strip (see Item 2 in Figure 2-11 on page 2-10).
	Battery is installed in backwards with '+' side of battery facing down in holder.	Remove the battery by gently lifting the retaining clip over the battery as you slide it to the right. Reinstall the battery with the '+' side up, by sliding it from right to left under the retaining clip until it snaps securely into the holder: 
	Bad battery.	Replace battery.

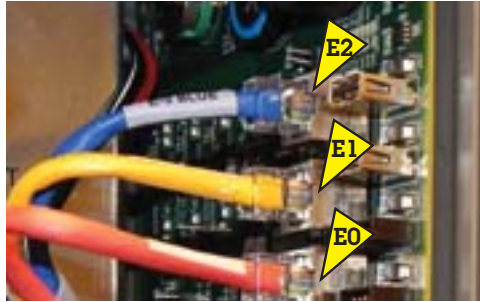
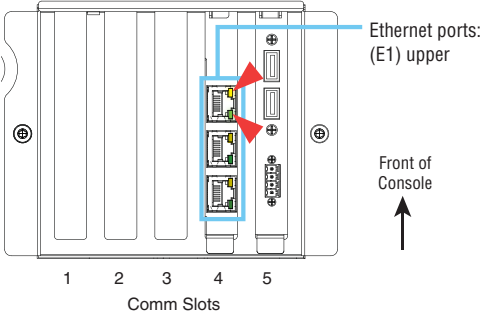
Table 6-2. TLS-450PLUS Troubleshooting

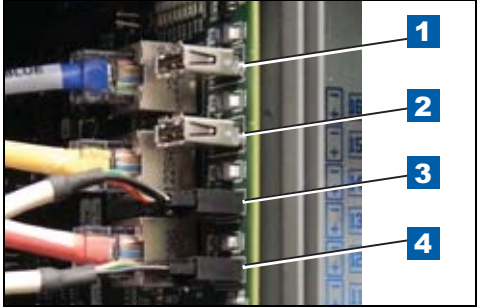
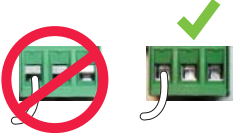

Symptom	Cause	Corrective Action
Sensor Connected To TLS-450PLUS But No Sensor Address Under Devices Menu	Sensor wires were connected while the console was ON.	Re-boot console.
	Sensor wiring installed incorrectly.	<p>1. Open the Display door.</p> <p>2. Polarity may be required for this device. Locate the questionable sensor's input wiring connections at the USM connector.</p> <p>If polarity required, verify the two wires are connected with white to + terminal and black to – terminal. (item 1 in diagram below)</p> <p>If three wire sensor, verify the three wires are connected as shown below (item 2 in diagram below):</p>  <p>3. Verify each of the wires is correctly seated in each of the plug's terminal clamps. If the clamps are not opened all the way when inserting the wires into the plug, the wires can be inserted behind the clamps preventing proper contact:</p> 
	Sensor input in USM or bad sensor.	Verify by connecting sensor to different input on USM module.
Bad USM module.	Replace USM module.	

Table 6-2. TLS-450PLUS Troubleshooting

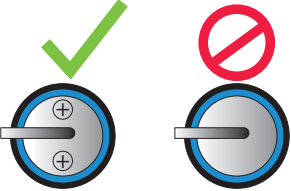
Symptom	Cause	Corrective Action
"Could Not Validate IButton" Displays On GUI	Features iButton is not seated properly in its holder.	<p>Check that iButton (Item 12 in Figure 2-11 on page 2-10) on the CPU board is installed correctly as shown below:</p>  <p>With flange end up, slide the iButton under the clip until it snaps securely into the holder.</p>
	Features iButton is not programmed.	Replace iButton with one that has been programmed with the required features.
	Bad Cyclic Redundancy (CRC) check sum error.	Replace CPU board.
Cannot Save Setup Data, "Data Retrieved" Error Message In Status Bar	SD Card in write protect mode.	<p>Remove the SD Card (item 10 in Figure 2-11 on page 2-10) by pushing in on the Card then quickly releasing it letting it spring free of its enclosure's latch so you can slide it out. While you have the Card out, check the position of the write protect slide on the side of the Card, making sure it is in the position shown below and then reinsert it in its enclosure until it clicks into the enclosure's latch.</p> 

Table 6-2. TLS-450PLUS Troubleshooting

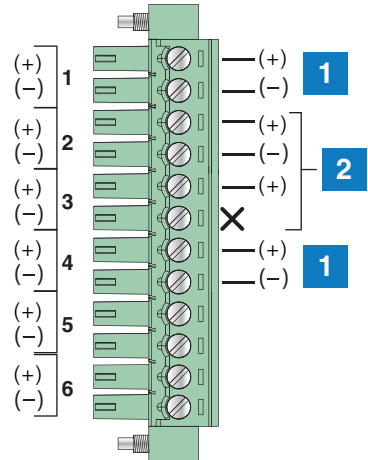
Symptom	Cause	Corrective Action
Relay Will Not Change State	Setup problem - relay is not enabled.	Verify relay is enabled in the GUI. Are relays setup on TLS-450PLUS?
	Connector is not pushed all the way in.	Verify the relay plug is pushed all the way into the connector (Item 4 in Figure 2-5 on page 2-5). Verify each of the wires is correctly seated in the plug's terminal clamps. If the clamps are not opened all the way when inserting the wires into the plug, the wires can be inserted behind the clamps preventing proper contact: 
	Incorrect input wiring from external device.	Verify external wiring into the relay input connector.
	Fuse missing or blown.	Install or replace fuse(s) with the correct type as indicated in Section 3.
	AC input board bad.	Replace AC input board.
	Power supply board bad.	Replace Power supply board.
	CPU board bad.	Replace CPU board.
	Comm backplane board bad.	Replace Comm backplane board.
External Input Does Not Recognize External Contact Closure	Setup problem - external input is not enabled.	Verify external input is enabled in the GUI. Verify proper alarm setup for relay trigger in the GUI.
	Incorrect external wiring to external input connector.	Verify the external input plug is pushed all the way into the connector on the I/O module. Verify each of the wires is correctly seated in the plug's terminal clamps. If the clamps are not opened all the way when inserting the wires into the plug, the wires can be inserted behind the clamps preventing proper contact: 
	I/O module bad.	Replace I/O module.
CPU board bad.	Replace CPU board.	

7 Component Removal

This sections contains instructions for removing/replacing the TLS-450PLUS console Ack Switch/Display door, CPU board, AC Input Filter, Power Supply board, Printer door, SD card, Features iButton, Backup Battery, and the SATA drive.

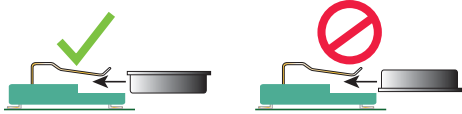
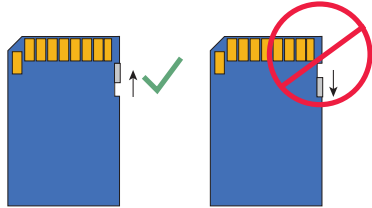
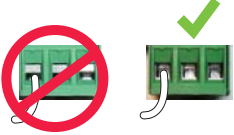
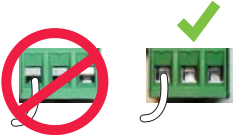
Safety Warnings

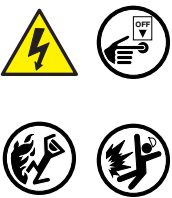
⚠ WARNING	
	<p>This console contains high voltages which can be lethal. It is also connected to low power devices that must be kept intrinsically safe.</p> <p>FAILURE TO COMPLY WITH THE FOLLOWING WARNINGS AND SAFETY PRECAUTIONS COULD CAUSE DAMAGE TO PROPERTY, ENVIRONMENT, RESULTING IN SERIOUS INJURY OR DEATH.</p> <ol style="list-style-type: none">1. Turn off and tag power at the circuit breaker. Do not connect the console AC power supply wires at the breaker until all devices are connected.2. Attach conduit from the power panel to the console's Power Area knockouts only.3. Comply with all applicable codes including: the National Electrical Code; federal, state, and local codes; and other applicable safety codes. <p>Connecting power wires to a live circuit can cause electrical shock that may result in serious injury or death.</p> <p>Routing conduit for power wires into the intrinsically safe compartment can result in fire or explosion resulting in serious injury or death.</p>

Precautions Against Static Electricity

Before removing electronic components from their anti-static bags read the following static electricity precautions.

1. Before handling any components, discharge your body's static electric charge by touching a grounded surface.
2. Do not remove parts from their anti-static bags until you are ready to install them.
3. Do not lay parts on the anti-static bags! Only the insides are anti-static.
4. When handling parts, hold them by their edges and their metal mounting brackets.
5. Avoid touching components or edge connectors that plug into slots and wear the anti-static wrist strap (Part No. 576010-908) included in your component replacement kit.
6. Never slide parts over any surface.
7. Avoid plastic, vinyl, and Styrofoam in your work area.



Before Turning Off Power

Before powering off the console perform a system backup:

1. Beneath the left side of the 450 Plus console, locate the USB Module and insert the V-R Backup thumb drive, minimum 4 GB, (P/N 332970-004) into one of the external USB ports on the USB module, P/N 333477-001 (see item 3 in Figure 7-1).

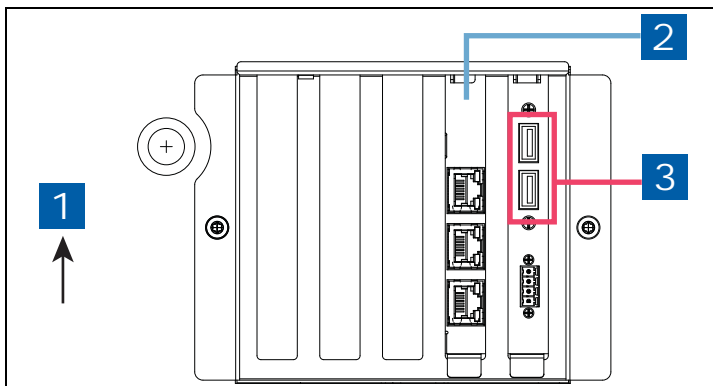

Figure 7-1. USB Board - USB Ports

LEGEND FOR NUMBERED BOXES IN Figure 7-1

1. Front of console
2. Ethernet Interface Module
3. USB Ports on USB Module

2. From the Home Screen touch **Menu > Software Upgrade > DB Backup** to view the Database Backup Screen (see Figure 7-2). Touch the down arrow in the Backup Destination field to select the Backup thumb drive inserted in Step 1, then follow the on-screen instructions to backup TLS-450PLUS console data.

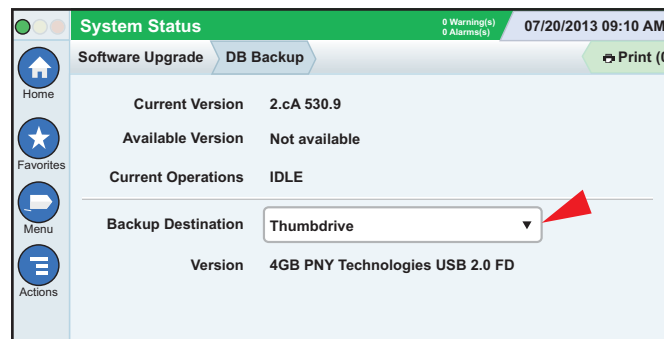

Figure 7-2. DB Backup Screen



3. Turn off, tag and lockout the breaker that supplies power to the console.

Removing The Ack Switch Panel/Display (Right) Door And CPU Board

To remove just the Acknowledge Switch Panel door (or optional Display door), complete Steps 1 - 6 in this section. To remove the CPU board, complete all Steps (1-10) in this section.

1. Remove the both left and right door screws and swing doors open to the left (see items 2/5 in Figure 2-1).
2. For the Ack Switch panel door remove the Ack Switch Panel cable plug from its CPU board connector (item 16 in Figure 2-11 on page 2-10).

For the optional Display door, remove the Display cable (pointer 1 in Figure 7-3) from the CPU board connector. Rotate the locking member of the cable's Display connector (1a pointer) up 90° from the connector's fixed base and slide cable end out.

3. Remove the LED Back light cable (pointer 2) from CPU board connector (see Figure 7-3).

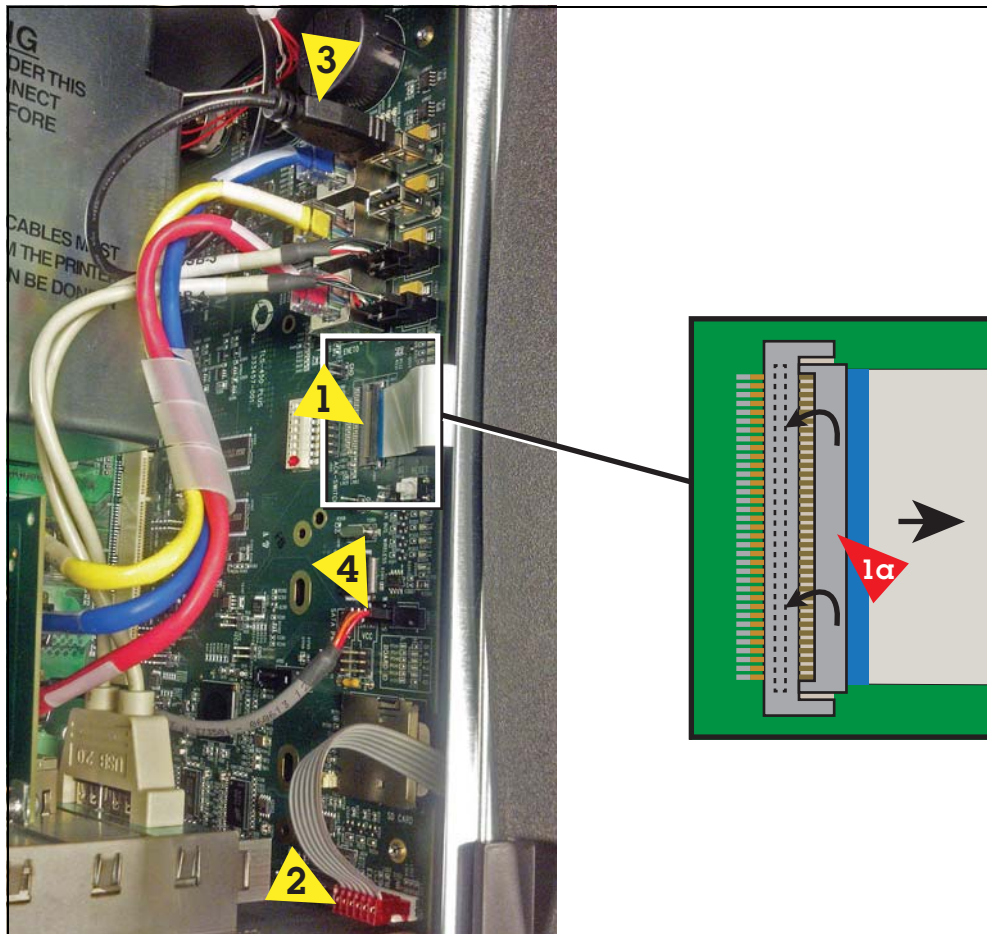

Figure 7-3. Remove Optional Printer And Display Cables From CPU Board

4. Remove the Ground wire at the top of the door (see Figure 7-4).



Figure 7-4. Remove Ground Wire From Ack Switch/Display Door

5. Remove the TLS-450PLUS Ack Switch Panel/Display door by removing the top and bottom hinge shoulder screws (see Figure 7-5).

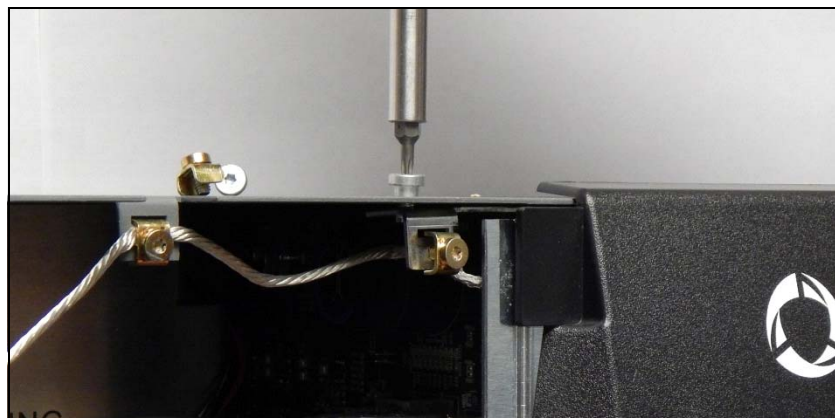

Figure 7-5. Remove Top And Bottom Optional Display Door Hinge Screws

6. Remove the USB module cables from the CPU board (two USB cables - top pointers; Wireless cable - bottom pointer) (see Figure 7-6).

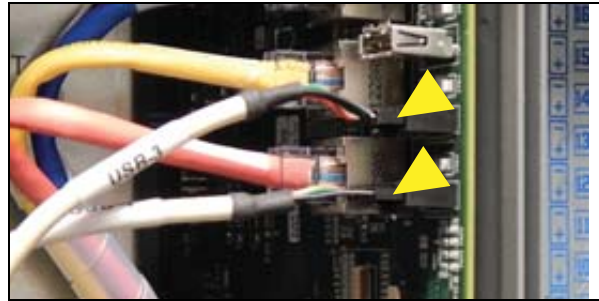

Figure 7-6. Remove USB Module Cables From CPU Board

7. Remove the three Ethernet Module cables E2 (blue), E1 (yellow) and E0 (red) from the CPU board (see Figure 7-7).

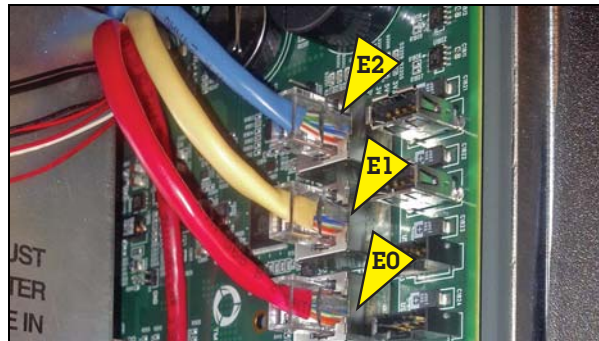

Figure 7-7. Remove Ethernet Module Cables From CPU Board

8. Remove the Printer cable (Pointer 3 Figure 7-3) and the Wireless cable (pointer 4 in Figure 7-3) from the CPU board connector.
9. Locate the three retention snap pins along the front edge of the CPU board. Position your forefinger beneath one of the pins and press up releasing the CPU board from the snap pin. Repeat at each of the remaining two retention pins.
10. Tilt the board a little away from the bulkhead and grasping the edge of the board pull out firmly to remove the board from its backplane board connector. Once the CPU board is free from the connector, slowly remove the board from the console.

Removing The AC Input Filter And Power Supply Board

1. Perform all of the Steps in the section entitled "Before Turning Off Power" on page 7-2.
2. Open the console doors as described in Step 1 of the section entitled "Removing The Ack Switch Panel/ Display (Right) Door And CPU Board" on page 7-3.
3. Remove the two T15 screws from the AC Channel cover and put the cover and screws aside (see Figure 7-8).



Figure 7-8. Remove AC Channel Cover

Legend For Figure 7-8			
Item	Description	Item	Description
1	AC Channel cover.	2	T15 screws (2).

4. Remove the three T15 screws in the AC Input Filter (item 1 in Figure 7-9).
5. Lift the Power Supply shield up to disengage the two retention snap pins in its right side flange and remove it from the console (item 2 in Figure 7-11).
6. Grasp the AC Input Filter handle (see item 3 in Figure 7-9) and slowly pull up and away from the Power Supply board until the two AC Input Filter plugs disconnect from the Power Supply board connectors. Lift the AC Input Filter out of the console. Remove the two T-15 screws that secure the AC Input board to the AC input board bracket. Place fingers under the AC Input board near each of the two retention pins and lift the board up until it is free of the pins.

To replace the AC Input Filter reverse the above steps. To remove the Power Supply Board continue to Step 7.



Figure 7-9. Removing AC Input Filter

Legend For Figure 7-9			
Item	Description	Item	Description
1	T15 screws (the middle one secures the Power Supply shield to the AC Input Filter bracket)	3	AC Input Filter handle
2	Power Supply shield		

7. Remove the two T15 screws (item 1 in Figure 7-10) that secure the Power Supply board to the console housing.
8. Place a finger under the edges of the Power Supply board near the upper right and lower left edges of the board and lift the board up until it is free of the three snap pins (item 2 in Figure 7-10).



WARNING! Shock hazard. Do not touch underside of Power Supply board beneath the five capacitors (identified by item 3 in Figure 7-10).

9. Disconnect the printer power cable from the Power Supply board connector J1.

10. Lift the board out of the console by its edges since there is still undischarged high voltage in the item 3 capacitors.

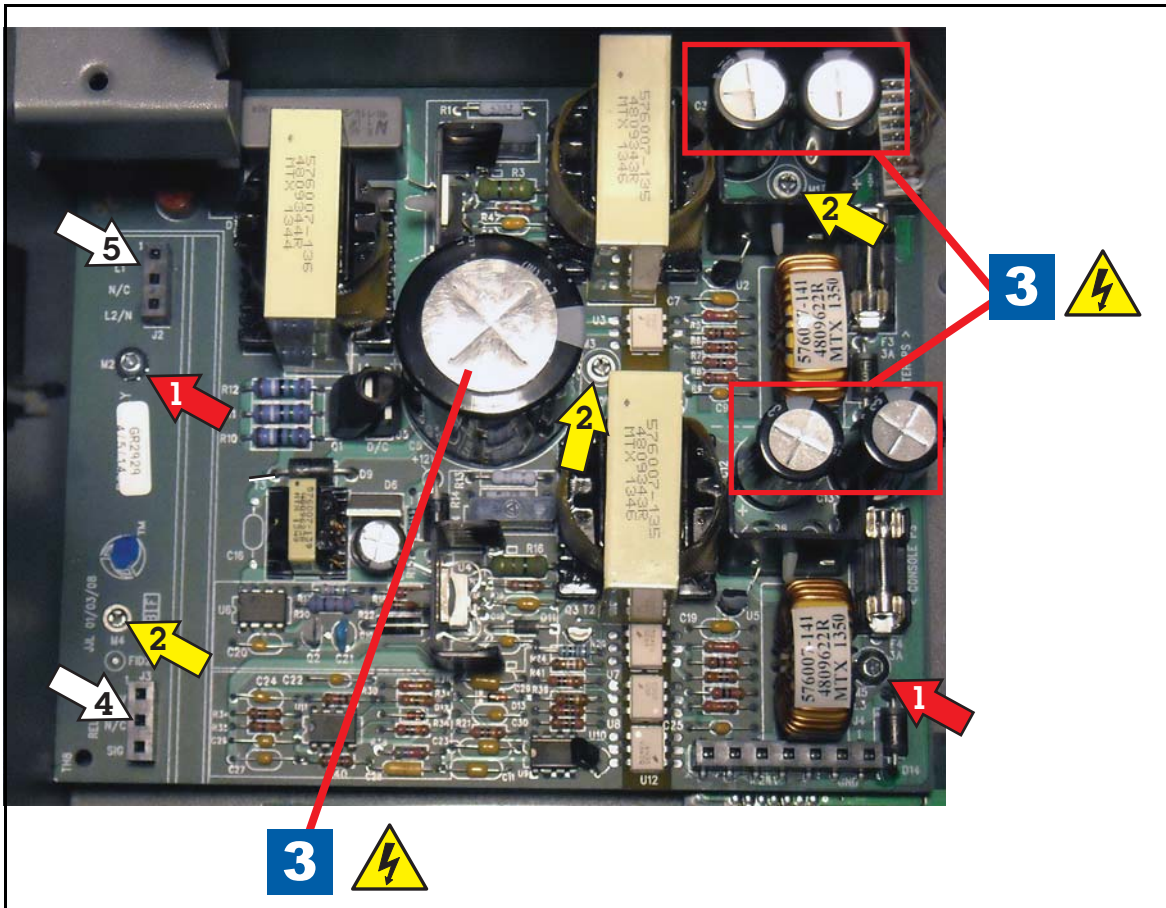



Figure 7-10. Removing Power Supply Board

Legend For Figure 7-10			
Item	Description	Item	Description
1	Power Supply Board T15 securing screws	3	Power Supply Board capacitor warning.
2	Power Supply Board retention snap pins		WARNING! The five capacitors identified by pointer 3, can hold a high charge, do not touch underside of board where these caps are soldered to board.

11. Get the new Power Supply board and lower it into the console.
12. Attach the printer power supply cable to its connector (J1) on the upper right corner of the replacement Power Supply board.
13. Line up the three holes in the Power Supply board (see item 2 in Figure 7-10) with the three retention pins in the back of the console housing and push the board down until the pins snap into position.
14. Install the two T15 screws (item 1 in Figure 7-10) and tighten them.

15. Notice that there are two male connectors on the bottom of the AC Input Filter board that plug into two female connectors on the Power Supply board. With the handle (item 3 of Figure 7-9) of the AC Input Filter against the left side of the console housing, line up the two AC Input Filter bottom connectors over the two female connectors (items 4 and 5 in Figure 7-10) on the Power Supply board and push down on the AC Input Filter until the connectors are firmly seated.
16. Place the Power Supply shield (item 2 in Figure 7-9) over the Power Supply board and lower it down onto its two retention pins (see item 2 in Figure 7-11) and snap it into place.
17. Install the three T15 screws in the AC Input Filter (see item 1 in Figure 7-9).
18. Replace the AC Channel cover and install the two T15 screws (see Figure 7-8).

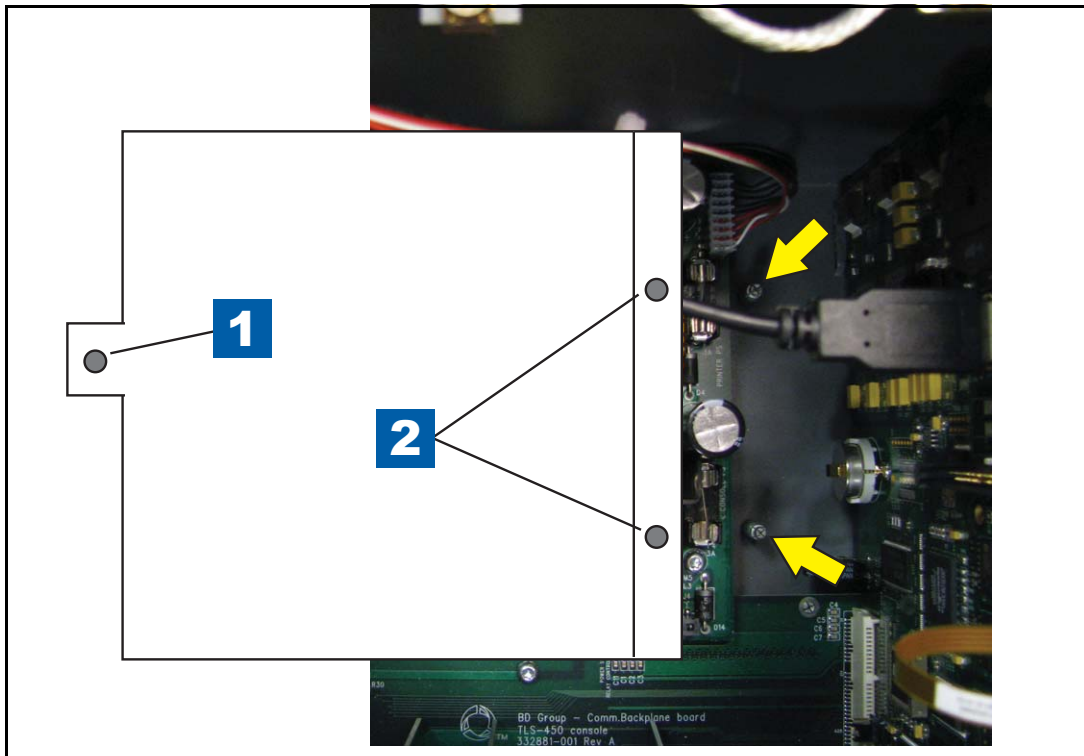

Figure 7-11. Replacing Power Supply shield over Power Supply board

Legend For Figure 7-11			
Item	Description	Item	Description
1	T15 screws	2	Board retention snap pins

Removing The Printer/Blank (Left) Door

1. Perform all of the Steps in the section entitled “Before Turning Off Power” on page 7-2.
2. Open the console doors as described in Step 1 of the section entitled “Removing The Ack Switch Panel/ Display (Right) Door And CPU Board” on page 7-3.

3. If a printer is installed, remove the printer's USB cable (pointer 3 in Figure 7-3) from the top USB connector (USB 1).
4. Loosen the T15 ground clamp screw securing the ground wire at the top of the Printer door and slide it free of the clamp (see Figure 7-12).

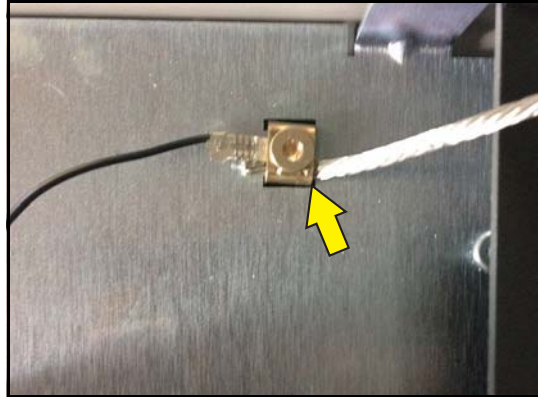

Figure 7-12. Removing Printer Door Ground Wire

5. If a printer is installed, unplug the Printer power cable plug from the Power Supply board connector. (see Figure 7-13).

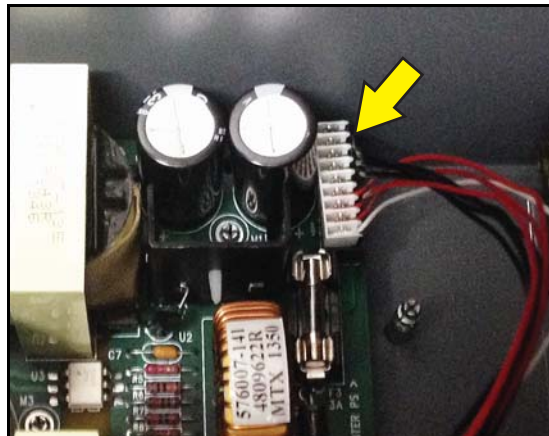

Figure 7-13. Removing Printer Door Ground Wire

6. Remove the TLS-450PLUS Printer door by removing the top and bottom hinge shoulder T15 screws (similar to the Ack Switch Panel/Display Door shoulder screws Figure 7-5).

Removing The Backup Battery

1. Perform all of the Steps in the section entitled "Before Turning Off Power" on page 7-2.
2. Open the right and left console doors as described in Step 1 of the section entitled "Removing The Ack Switch Panel/Display (Right) Door And CPU Board" on page 7-3.
3. Locate the backup battery at the top of the CPU board (see pointer 2 in Figure 7-14).

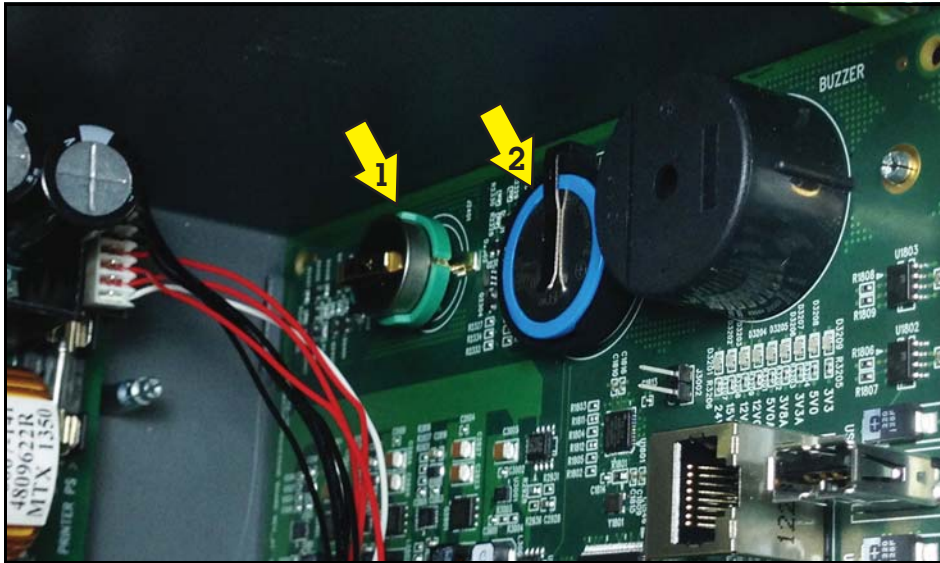
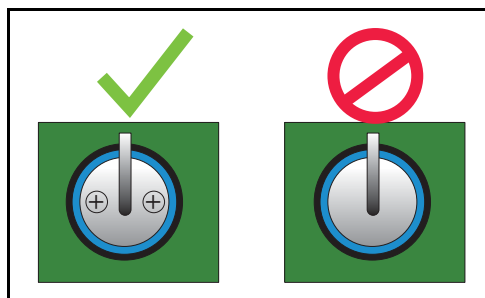

Figure 7-14. Locating Features iButton And Backup Battery

Legend For Figure 7-14			
Item	Description	Item	Description
1	Features iButton	2	Backup Battery

- Remove the battery by gently lifting the retaining clip over the battery as you slide it down out of its holder. Reinstall the battery with the '+' side up, by sliding it up under the retaining clip until it snaps securely into the holder:



Removing The Features iButton

- Perform all of the Steps in the section entitled "Before Turning Off Power" on page 7-2.
- Open the console doors as described in Step 1 of the section entitled "Removing The Ack Switch Panel/ Display (Right) Door And CPU Board" on page 7-3.
- Perform all of the steps in the section entitled "Removing The Ack Switch Panel/Display (Right) Door And CPU Board" on page 7-3.



4. Holding the CPU board by its edges, place it on a clean surface. Locate the Features iButton at the top of the CPU board (see pointer 1 in Figure 7-14).
5. Remove the iButton by gently lifting the retaining clip over the iButton as you slide it out of its holder.
6. When inserting the iButton make sure the flanged side is up as it is slid into its holder:

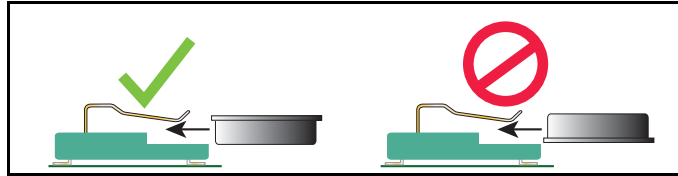

7. Replacing the CPU board and perform a Features Update procedure (Menu>Software Upgrade>Upgrade Features) to install any new software.

Removing The SD Card

1. Perform all of the Steps in the section entitled “Before Turning Off Power” on page 7-2.
2. Open the console doors as described in Step 1 of the section entitled “Removing The Ack Switch Panel/ Display (Right) Door And CPU Board” on page 7-3.
3. Locate the SD card on the lower front edge of the CPU board:

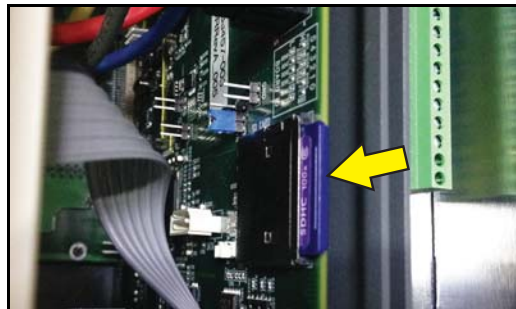

4. Remove the SD Card by pushing in on card then quickly releasing it, letting it spring free of its enclosure's latch then slide it out.
5. Perform a database restore procedure (Menu>Software Upgrade>DB Restore) to reload system data into a new SD card.
6. Before replacing the SD Card, always check the position of the write protect slide on the side of the SD Card, making sure it is in the position shown below and then reinsert it in its enclosure until it clicks into the enclosure's latch:

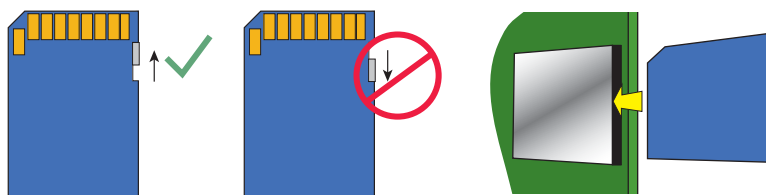

Removing The SATA Drive

1. Perform all of the Steps in the section entitled “Before Turning Off Power” on page 7-2.
2. Open the console doors as described in Step 1 of the section entitled “Removing The Ack Switch Panel/ Display (Right) Door And CPU Board” on page 7-3.
3. Locate the small SATA drive board in the middle of the CPU board (pointer 1 below):

Note: SATA drive may appear slightly different than version shown.



4. Wearing a static avoidance wrist strap grounded to the console, push in on the small button (pointer 2 above) to release the plug latch and lift the small SATA drive board from the connector.
5. Handle the SATA drive by its edges and avoid touching components on the board. To reinstall push the SATA drive board plug into the CPU connector until the plug latch snaps into place.
6. Perform a database restore procedure (Menu>Software Upgrade>DB Restore) to reload system data into a new SATA drive.



8 Console Diagnostics Using The TLSTECH Diagnostic Tool

Remote users may connect to the TLS-450PLUS using the freeware program putty.exe to run the TLSTECH diagnostics program discussed in this section.

Downloading and Using Putty

1. The Putty program can be downloaded from the following website:
<http://www.chiark.greenend.org.uk/~sgtatham/putty/download.html>
2. Once in the site, click on putty.exe as shown below:

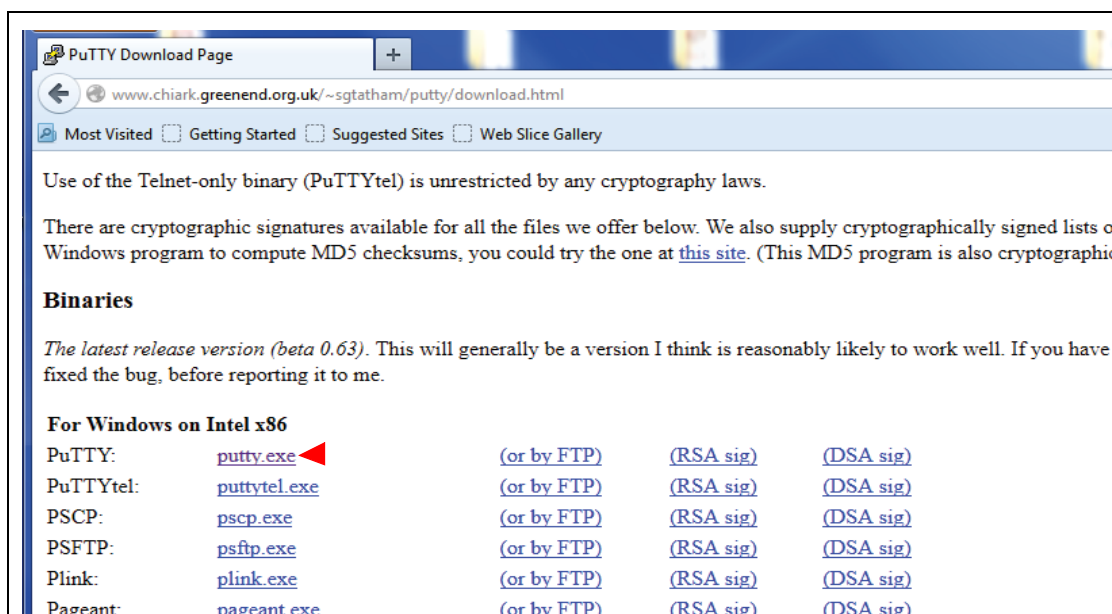

3. Download putty.exe to your desktop. Before using putty and TLSTECH, the laptop needs to be setup to connect to the TLS-450PLUS.

Reconfigure the Laptop PC Prior To Using TLSTECH

Prior to connecting to the TLS-450PLUS using the TLSTECH Diagnostic Tool, the IP address of the Laptop/PC has to be reconfigured.

LAPTOP/PC SETUP FOR A WINDOWS 7 OPERATING SYSTEM

1. From Control Panel, open 'Network and Sharing Center' - click on 'Local Area Connection'.

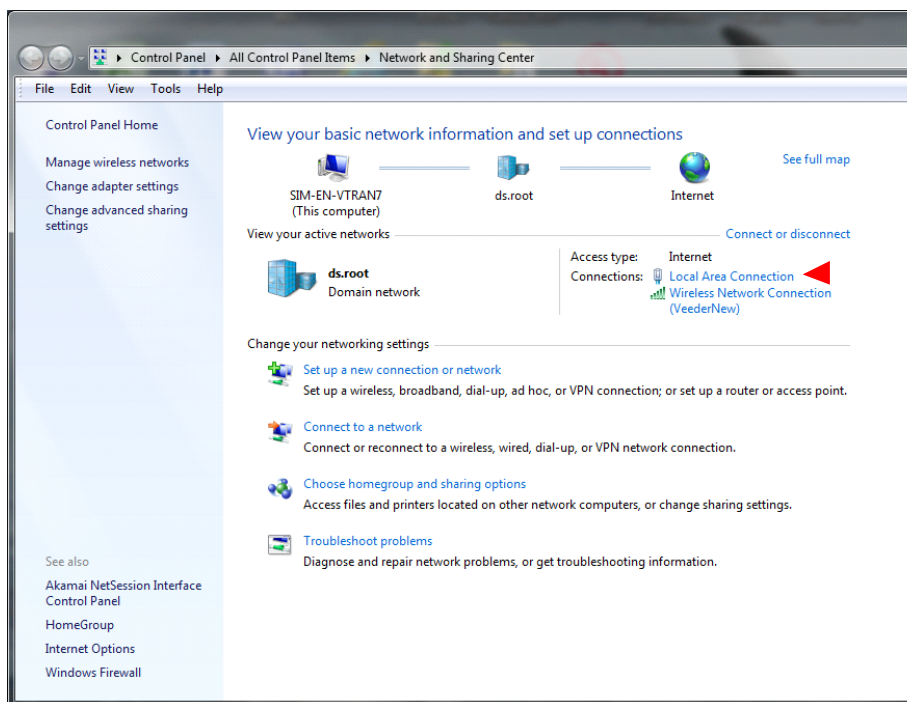

2. The Local Area Connection Status dialog box opens. Click on the **Properties** button.

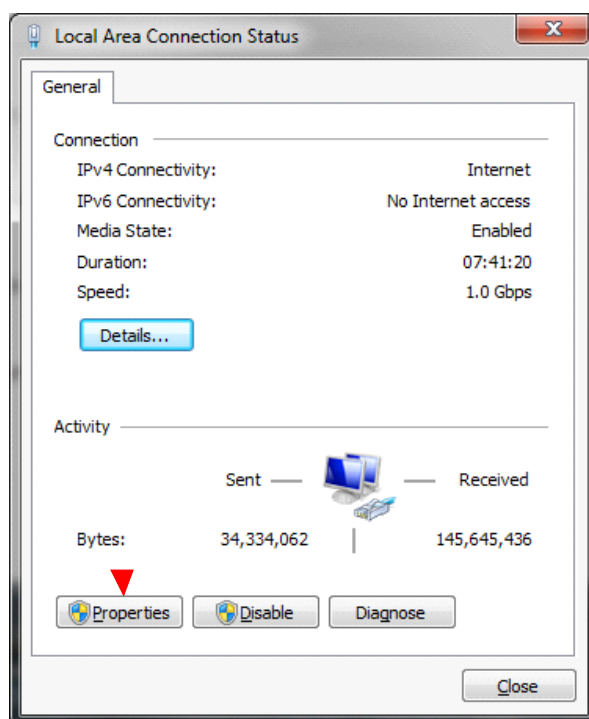

3. In the Local Area Connection Properties dialog box 'highlight Internet Protocol Version 4 (TCP/IPv4)' and then click the **Properties** button.

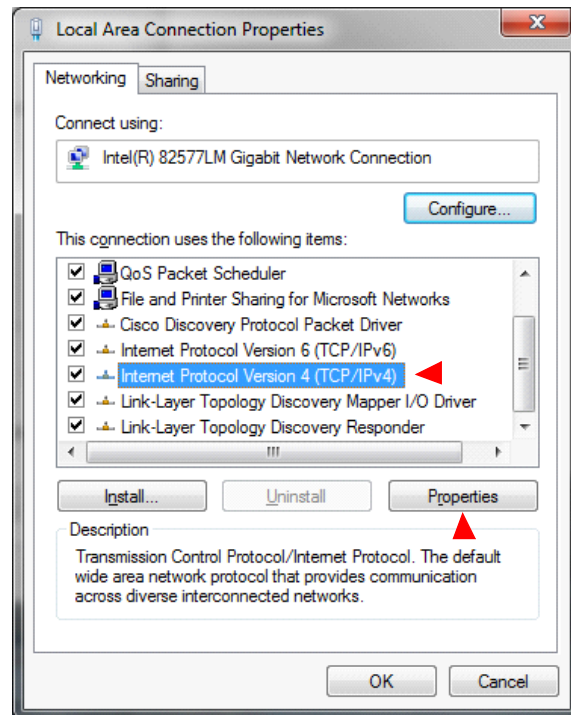

4. In the 'Internet Protocol Version 4 (TCP/IPv4) Properties' dialog box, Check the **Use the following IP address box** and enter the Static IP address shown in the figure (this is the IP address for the Laptop/PC).

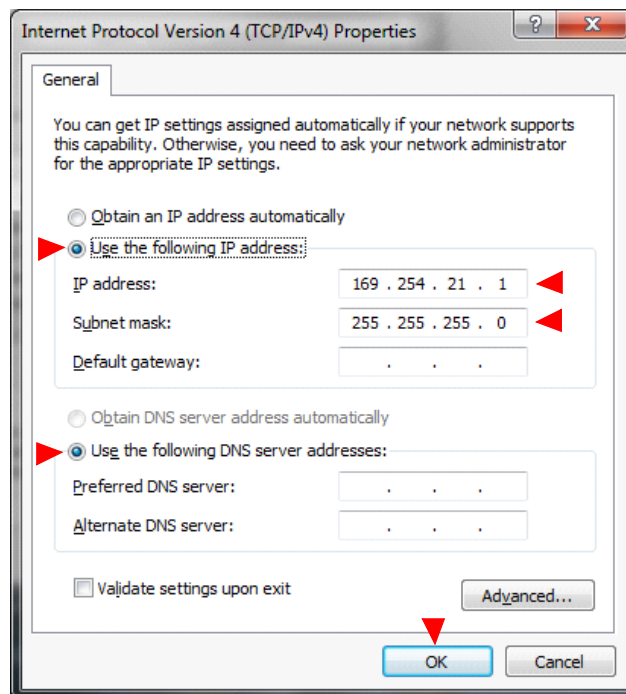

- Once the IP address is entered, click in the Subnet mask field; the Subnet mask address will fill in automatically, if not, enter 255.255.255.0.
- Select the 'Use the following DNS server addresses:' radio button.
- Click the **OK** button to save the settings.
- Your Laptop/PC is ready to TLSTECH to the TLS-450PLUS console.
- When you have finished communicating with the TLS-450PLUS console, you will have to reconfigure the laptop/PC to its original TCP/IP settings. Repeat steps 1-4 above. When the 'Internet Protocol Version 4 (TCP/IPv4) Properties' dialog box appears, select the 'Obtain an IP address automatically' radio button (this selection is needed to connect to the internet) and click the **OK** button.

LAPTOP/PC SETUP FOR A WINDOWS XP OPERATING SYSTEM

- From Control Panel, open 'Network Connections' and click on 'Local Area Connection 2'.

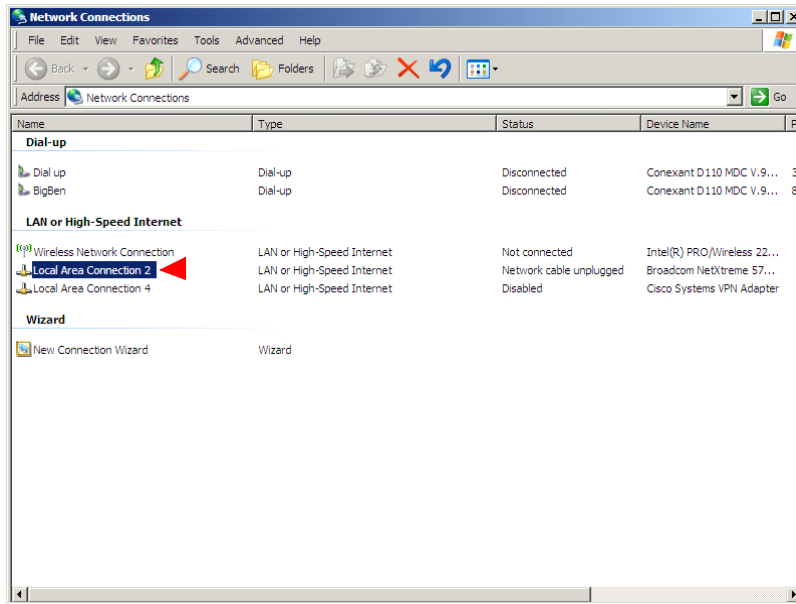

- When the 'Local Area Connection 2 Properties' dialog box appears, select 'Internet Protocol (TCP/IP)', then click on the **Properties** button.

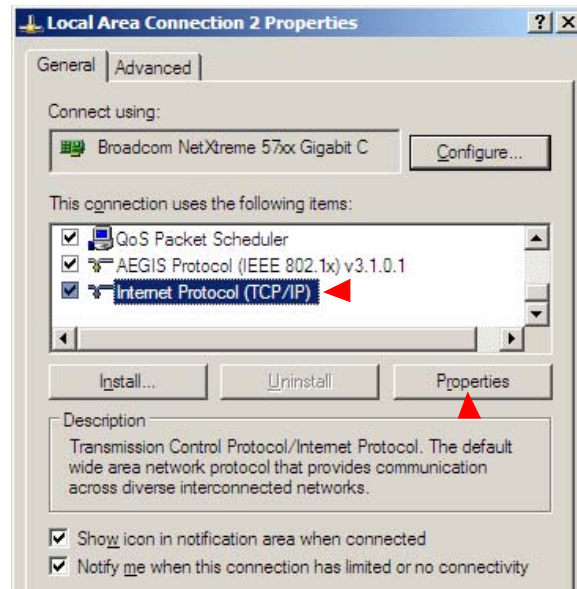

- When the 'Internet Protocol (TCP/IP) Properties' dialog box appears, select 'Use the following IP address' radio button and enter the Static IP address below (this is the default IP address for the TLS-450PLUS console). Once the IP address is entered, click in the Subnet mask field; the Subnet mask address will fill in automatically, if not enter 255.255.255.0. Select 'Use the following DNS Server address' radio button. Click **OK** to save the setting.

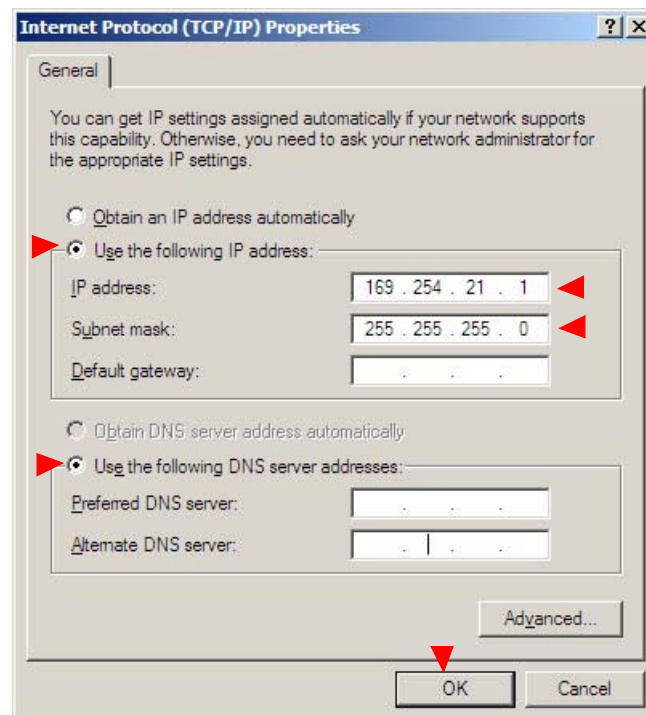

4. Laptop/PC is ready to TLSTECH to the TLS-450PLUS console.
5. When you have finished communicating with the TLS-450PLUS console, you will have to reconfigure the laptop/PC to its original TCP/IP settings. Repeat steps 1-3 above. When the 'Internet Protocol (TCP/IP) Properties' dialog box appears, select the 'Obtain an IP address automatically' radio button (this selection is needed to connect to the internet) and click the **OK** button.

Using Putty And The TLSTECH Diagnostic Tool

1. Doubleclick on the putty.exe icon you downloaded earlier to open the program.



2. Click on **Run**.

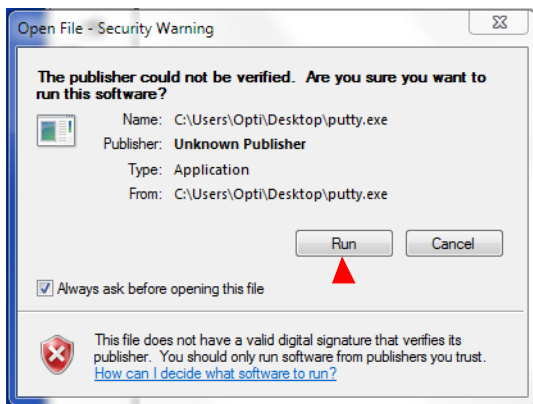

3. Make the selections on the Putty Configuration dialog box as shown below and ignore the Category field selections. In the 'Host Name for IP Address' field, enter the IP address of the TLS-450PLUS console (169.254.21.12). Click the **Open** button to save settings and open the TLSTECH login screen.

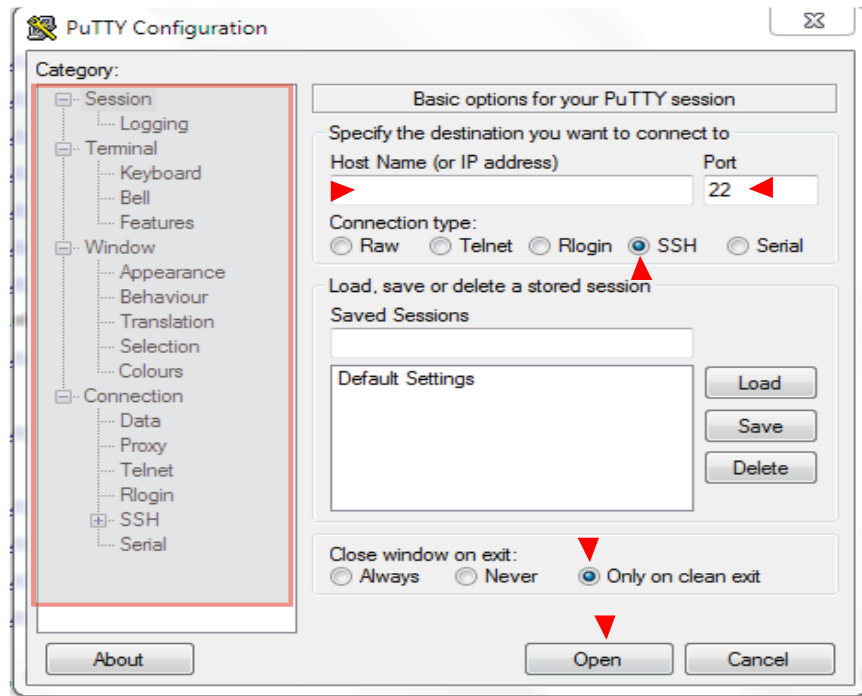

4. When the login screen appears, login as **tlstech**:

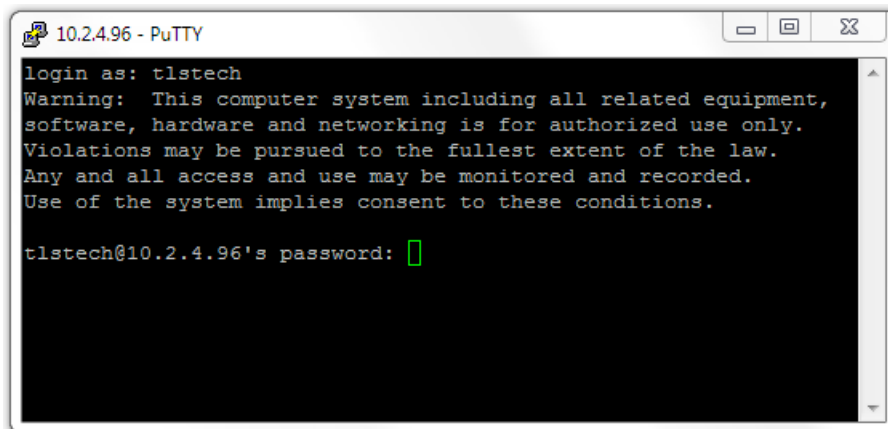

5. Enter the password: **tlstech**

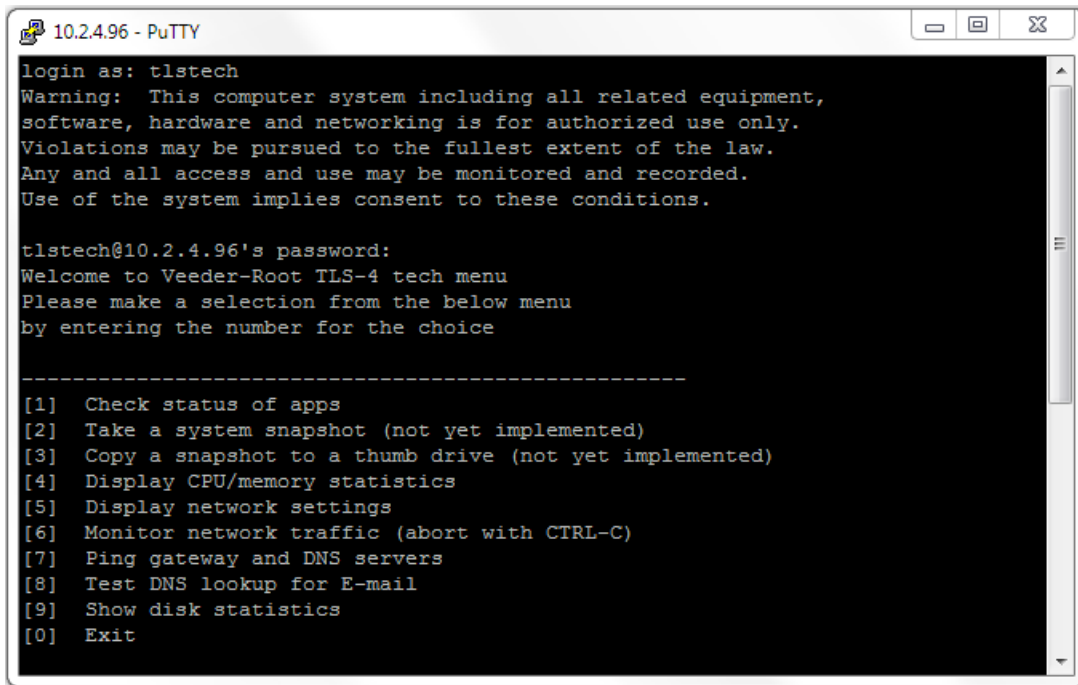
A screenshot of a PuTTY terminal window titled "10.2.4.96 - PuTTY". The terminal displays a login prompt for "tlstech", a warning about authorized use, and a password prompt. After logging in, it shows a "Welcome to Veeder-Root TLS-4 tech menu" and a list of menu options numbered [1] through [0]. The options are: [1] Check status of apps, [2] Take a system snapshot (not yet implemented), [3] Copy a snapshot to a thumb drive (not yet implemented), [4] Display CPU/memory statistics, [5] Display network settings, [6] Monitor network traffic (abort with CTRL-C), [7] Ping gateway and DNS servers, [8] Test DNS lookup for E-mail, [9] Show disk statistics, and [0] Exit.

```
10.2.4.96 - PuTTY
login as: tlstech
Warning: This computer system including all related equipment,
software, hardware and networking is for authorized use only.
Violations may be pursued to the fullest extent of the law.
Any and all access and use may be monitored and recorded.
Use of the system implies consent to these conditions.

tlstech@10.2.4.96's password:
Welcome to Veeder-Root TLS-4 tech menu
Please make a selection from the below menu
by entering the number for the choice

-----
[1] Check status of apps
[2] Take a system snapshot (not yet implemented)
[3] Copy a snapshot to a thumb drive (not yet implemented)
[4] Display CPU/memory statistics
[5] Display network settings
[6] Monitor network traffic (abort with CTRL-C)
[7] Ping gateway and DNS servers
[8] Test DNS lookup for E-mail
[9] Show disk statistics
[0] Exit
```

6. When the TLSTECH menu appears, enter the number of a desired choice then press **Enter** to view that result. To exit the program, press 0 then press Enter.

TLSTECH Menu Examples

The TLSTECH menu is shown below and examples of each menu item are shown below.

- [1] Check status of apps
- [2] Take a system snapshot (not yet implemented)
- [3] Copy a snapshot to a thumb drive (not yet implemented)
- [4] Display CPU/memory statistics
- [5] Display network settings
- [6] Monitor network traffic (abort with CTRL-C)
- [7] Ping gateway and DNS servers
- [8] Test DNS lookup for E-mail
- [9] Show disk statistics
- [0] Exit

MENU SELECTION 1**Checking status of apps**

```

1674  mysql  mysqld
2275  exim    sendmail
6033  tlsuser SOAPServ
6023  tlsuser TLS-450PLUSGUI
2366  tlsuser CommServices
2353  tlsuser CoreServer
2343  tlsuser CommandProcesso
2333  tlsuser DeviceServer
2273  tlsuser WatchDog
2236  tlsuser MaintServer
1686  root    httpd
21676 daemon \_ httpd
29299 daemon \_ httpd
26014 daemon \_ httpd

```

MENU SELECTION 4**Display system statistics**

```
Linux 2.6.35.3-433-g0fae922+ (TLS-450PLUS) 08/08/13 _armv7l_ (1 CPU)
```

```
08/08/13 09:35:26
```

```

avg-cpu:  %user  %nice  %system  %iowait  %steal  %idle
           13.75   0.00   15.95   0.18    0.00   70.13

```

```
09:35:26 up 6 days, 33 min, 1 user, load average: 2.78, 2.81, 2.77
```

```

                total      used      free      shared    buffers    cached
Mem:            505792    357612    148180         0     39600    197288
-/+ buffers/cache:
                120724    385068
Swap:            0         0         0

```

MENU SELECTION 5

Displaying network settings

Kernel Interface table

```
eth0  Link encap:Ethernet HWaddr 00:50:83:f0:04:99
      inet addr:10.2.1.71 Bcast:10.2.1.255 Mask:255.255.255.0
      inet6 addr: fe80::250:83ff:fef0:499/64 Scope:Link
      UP BROADCAST RUNNING MULTICAST MTU:1500 Metric:1
      RX packets:1833262 errors:0 dropped:0 overruns:0 frame:0
      TX packets:440681 errors:0 dropped:0 overruns:0 carrier:0
      collisions:0 txqueuelen:1000
      RX bytes:142122262 (135.5 MiB) TX bytes:357490031 (340.9 MiB)
      Base address:0x2000
```

```
eth0:9 Link encap:Ethernet HWaddr 00:50:83:f0:04:99
```

...

MENU SELECTION 6

Monitoring network traffic (CTRL-C to abort)

```
Every 2.0s: /bin/netstat -s | grep -A 7 '^Ip:'
```

```
Thu Aug 8 09:36:30 2013
```

```
Ip:
```

```
13598624 total packets received
112 with invalid addresses
0 forwarded
0 incoming packets discarded
13598512 incoming packets delivered
13266813 requests sent out
2 dropped because of missing route
```

MENU SELECTION 7

Pinging gateway and DNS servers

Pinging gateway

```
PING 10.20.95.1 (10.20.95.1): 56 data bytes
64 bytes from 10.20.95.1: icmp_seq=0 ttl=255 time=0.760 ms
64 bytes from 10.20.95.1: icmp_seq=1 ttl=255 time=1.114 ms
64 bytes from 10.20.95.1: icmp_seq=2 ttl=255 time=0.606 ms
--- 10.20.95.1 ping statistics ---
3 packets transmitted, 3 packets received, 0% packet loss
round-trip min/avg/max/stddev = 0.606/0.827/1.114/0.213 ms
```

Pinging name servers

```
PING 10.20.77.5 (10.20.77.5): 56 data bytes
64 bytes from 10.20.77.5: icmp_seq=0 ttl=127 time=0.532 ms
64 bytes from 10.20.77.5: icmp_seq=1 ttl=127 time=0.404 ms
64 bytes from 10.20.77.5: icmp_seq=2 ttl=127 time=0.387 ms
--- 10.20.77.5 ping statistics ---
3 packets transmitted, 3 packets received, 0% packet loss
round-trip min/avg/max/stddev = 0.387/0.441/0.532/0.065 ms
PING 10.28.54.15 (10.28.54.15): 56 data bytes
64 bytes from 10.28.54.15: icmp_seq=0 ttl=124 time=39.489 ms
64 bytes from 10.28.54.15: icmp_seq=1 ttl=124 time=27.339 ms
64 bytes from 10.28.54.15: icmp_seq=2 ttl=124 time=27.159 ms
--- 10.28.54.15 ping statistics ---
3 packets transmitted, 3 packets received, 0% packet loss
round-trip min/avg/max/stddev = 27.159/31.329/39.489/5.770 ms
```

MENU SELECTION 8**Testing Internet e-mail MX lookup with configured DNS servers**

```
Server:      10.20.77.5
Address:     10.20.77.5#53
```

Non-authoritative answer:

```
veeder.com mail exchanger = 10 mail.global.frontbridge.com.
```

Authoritative answers can be found from:

mail.global.frontbridge.com internet address = 216.32.180.190
mail.global.frontbridge.com internet address = 216.32.181.178
mail.global.frontbridge.com internet address = 65.55.88.22
mail.global.frontbridge.com internet address = 207.46.163.30
mail.global.frontbridge.com internet address = 213.199.154.190
mail.global.frontbridge.com internet address = 213.199.154.254
mail.global.frontbridge.com internet address = 213.199.180.150
mail.global.frontbridge.com internet address = 216.32.180.22

Server: 10.28.54.15

Address: 10.28.54.15#53

Non-authoritative answer:

veeder.com mail exchanger = 10 mail.global.frontbridge.com.

Authoritative answers can be found from:

mail.global.frontbridge.com internet address = 216.32.180.22
mail.global.frontbridge.com internet address = 216.32.180.190
mail.global.frontbridge.com internet address = 216.32.181.178
mail.global.frontbridge.com internet address = 65.55.88.22
mail.global.frontbridge.com internet address = 207.46.163.30
mail.global.frontbridge.com internet address = 213.199.154.190
mail.global.frontbridge.com internet address = 213.199.154.254
mail.global.frontbridge.com internet address = 213.199.180.150

MENU SELECTION 9

Showing disk related information

Disk devices:

NAME	FSTYPE	SIZE	MOUNTPPOINT
mmcblk0		3.8G	

```
|-mmcblk0p1          1.9G /
|-mmcblk0p2          1.9G
```

Disk usage:

Filesystem	Type	Size	Used	Avail	Use%	Mounted on
rootfs	rootfs	1.9G	1013M	742M	58%	/
/dev/root	ext3	1.9G	1013M	742M	58%	/
tmpfs	tmpfs	10M	4.0K	10M	1%	/dev
tmpfs	tmpfs	247M	228K	247M	1%	/tmp
tmpfs	tmpfs	247M	4.0K	247M	1%	/dev/shm
tmpfs	tmpfs	247M	0	247M	0%	/run

IO statistics:

03/08/14 08:26:42

Device:	tps	kB_read/s	kB_wrtn/s	kB_read	kB_wrtn
mmcblk0	0.80	28.91	7.16	141526	35052
mmcblk0p1	1.74	28.71	7.16	140521	35044

mmcblk0p20.030.140.006698

9 Probe Troubleshooting

This section contains basic probe problem diagnosis and suggested corrected actions for troubleshooting Magnetostrictive Probes (Table 9-1). Refer to TLS-450PLUS Site Prep and Installation Manual (Veeder-Root No. 577014-073) and the appropriate probe installation manual for more information about probe, conduit, and wiring installation.

Note: Removing the probe from the tank while connected to the console will cause a “Sudden Loss Alarm” which must be cleared after the probe is reinstalled.



Turn off, tag, and lockout power to the console before opening display door assembly!

Table 9-1. Mag Probe Troubleshooting

Alarm	Problem	Probable Cause	Corrective Procedure
N/A	Incorrect height/volume reading	Incorrect float size programmed	Reprogram actual installed float size
		Incorrect or missing setup data	Print out setup data and check for errors.
		Incorrect tank tilt value	Check tank tilt and correct if necessary.
		Probe wired to wrong probe channel on probe module	Verify probe is wired to correct channel.
		Probe not sitting on bottom of tank	Check and correct position of probe, if necessary.
		Fuel float stuck in riser tube.	Remove float from riser and install split-ring collar (P/N 576008-617) on probe shaft below riser tube to prevent recurrence of problem.
		Water or fuel float assembly missing or ring magnet defective.	Replace float assembly.
		Fuel float assembly installed upside down	Correct float assembly installation.
		Dirty probe shaft.	Clean probe shaft so that float moves freely up and down.
		Defective probe	Swap with probe from another tank. If problem follows probe, replace probe.
Water Warn/ High Water Alarm	Incorrect water height reading	Wrong or missing ballast	Install correct water float assembly.
		Water float sitting on debris at bottom of tank.	Check for debris on bottom of tank and clean if necessary.
Invalid Fuel Level	Invalid fuel height on warning display	Fuel level is too low and fuel float is sitting on the water float.	Call for delivery.
Low Product Alarm	Low or invalid product	Fuel is too low	Call for delivery.

9 Probe Troubleshooting

Table 9-1. Mag Probe Troubleshooting

Alarm	Problem	Probable Cause	Corrective Procedure
N/A	Fuel level reading equals full tank volume even though fuel level is below full volume.	Fuel float stuck in riser.	Remove float from riser and install split-ring collar (P/N 576008-617) on probe shaft below riser tube to prevent a recurrence of the problem.
	Probe reading on console display disappears or appears intermittently.	Defective probe cable	Replace cable.
	Ghost Deliveries.	Splices in wiring	See Note 1.
		Defective field wiring	Check for open or shorted wires, or absence of epoxy seal kits around field connections. Refer to "Field Troubleshooting Probe-Out Alarms" procedure below for more details.
		Other control wires in probe conduit	See Note 1.
		Conduit not grounded properly	See Note 1.
		Non-metallic conduit present	See Note 1.
		Variable speed submersible pump in use	See Note 1.
		Defective barrier board	Replace barrier board.
		Defective probe	Replace probe.
	Fuel temperature reading is incorrect	Defective thermal sensor in probe.	Replace probe.
	Leak Test Invalid - Recent delivery	A delivery occurred during the leak detect test or within 8 hours prior to the console's entering the leak detect mode.	Retest, waiting longer than 8 hours after last delivery.
	Leak Test Invalid - Tank level low	Fluid level is too low. Insufficient product in tank for satisfactory thermal compensation.	Fill tank to half full or more.
	Leak Test Invalid - First hour error	Consult factory.	Consult factory.
Leak Test Invalid - Last hour error	Consult factory.	Consult factory.	

Table 9-1. Mag Probe Troubleshooting

Alarm	Problem	Probable Cause	Corrective Procedure
N/A	Leak test invalid - temp out of range	Fuel temp reading is below 0°F or above 100°F.	Retest when product temperature is between 0 -100°F.
		Defective probe.	Replace probe.
	Temp change error - w/0.1 gph test	Temp of fuel changed by more than 1/10th degree per hour during the leak test.	Retest.
	Temp change error - w/0.2 gph test (Mag 2 probe only).	Temp of fuel changed by more than 2/10th degree per hour during the leak test.	Retest.
	Temp change error - zone change error	Temp of any covered thermistor changed more than 3/10th degree per hour during leak test.	Retest.
	Temp change error - head change error	Temp in head of probe changed more than 1/10th degree per hour during leak test.	Retest.
Fuel Quality Alarm - Tank has Ethanol-Blended Gasoline floats	Water/phase separation	Water/phase separation may be present in tank.	Test fuel at bottom of tank to ensure water/phase separation is not present.
Density Warning	Tank product density has exceeded preset limits.	The tank density is either greater than the tank density low limit plus 1.00 KG/M ³ (0.062 LBS/FT ³) , or is less than the tank density high limit minus 1.00 KG/M ³ (0.062 LBS/FT ³).	Verify fluid density. Retest when product density is within the tank density low and high limits.

NOTE 1. Refer to TLS-450PLUS *Site Prep and Installation Manual* (Veeder-Root No. 577014-073).

Field Troubleshooting Probe-Out Alarms

You must verify all locations utilizing shielded cable are wired correctly.



Turn off, tag, and lockout power to the console before opening display door assembly!

Verify that the drain wire of the shielded cable is connected to the console end only. If the drain wire is connected on both ends this creates a ground loop which can produce Probe-Out Alarms. Remove power from the console before disconnecting the probe cable from the probe.

Follow these steps in sequence to troubleshoot probe-out alarms.

All probes returned for a warranty claim must be accompanied with the documentation produced during the following troubleshooting procedures to document the failure.

For any of the following steps that produce a printout from the console, those printouts must be provided with any returned probe.

If no printer is available then you must record the information specified below:

1. From the Home screen touch **Menu>Reports>Alarms>Reports**
 - Print / record the active alarms
2. From the Home screen touch **Menu>Diagnostics>Probe>Overview**
3. Select the malfunctioning probe and view each of the diagnostics tab screens. Print out the contents of each tab screen report for the suspect probe.
4. The Probe distance from the console must be less than 1000 feet. If the distance is greater than this probe operation is not guaranteed.
5. Ensure the probe wiring conforms to the requirements detailed in the TLS-450PLUS Site Prep and Installation Manual (Veeder-Root No. 577014-073).
6. Verify the console is grounded correctly.
 - Is the ground wire at least a 12AWG conductor? Remove ground cable from the grounding lug inside the console, use an ohmmeter to measure resistance from the ground wire to a known good ground. The resistance reading should be less than 1ohm.
 - If resistance is greater than 1 ohm, the console is not properly grounded. Either repair the ground connection or contact the installation company to ensure proper grounding is established.
7. Verify the console is on a separate circuit breaker with no shared branch circuits.
8. Verify the polarity of the probe wiring is correct from the probe to the console. The probe cable black conductor must be connected to the probe module (-) Negative. The probe cable white conductor must be connected to the probe module (+) Plus. NOTE: If probe is wired backwards it will be recognized as a liquid sensor.
9. Disconnect the probe cable connector from the probe and inspect both the probe cable female pins and the male pins on the probe for corrosion. If corrosion or contamination is suspected clean with electrical cleaning solution and reconnect probe cable. Verify alarm condition is cleared.
10. Open probe junction box and inspect connections for the probe wires and the connecting field wiring. These connections must have Veeder-Root supplied epoxy packs on the splices. Corroded splices will create Probe Out alarms. If Veeder-Root supplied epoxy packs are present, inspect them to make sure there is no water inside the packs where the connections are made. Verify that the wire nuts and cable sheathing are immersed in epoxy. The epoxy should be "rock hard". If no epoxy packs were utilized, the Veeder-Root installation procedures were not followed. Refer to the appropriate installation manual for correct installation procedures.
11. Before proceeding, ensure that console power is Off. (If only one tank exists or the suspect probe cannot be installed in another tank at the site, proceed to step 13). Swap the non-working probe with a working one from another tank to determine if the problem follows the probe or stays with the tank. When swapping probes, disconnect the probe cable connector on the top of the probes and swap the probes between the tanks. Do not swap probes and cables at the same time. If the problem moves to the other tank, replace the probe. If the problem stays with the original tank after swapping probes, go to step 13. If the Probe Out clears and does not return on either tank wait 30 minutes to see if alarm returns. If it does not return, leave the probes in-place and wait for the customer to contact you if the problem reoccurs. If problem reoccurs within a reasonable period of time on the tank the suspect probe is now in, then replace the probe. If it returns on the original tank then follow the steps for troubleshooting wiring and connectors.
12. Replace the probe cable. If the problem persists, move the wires on the probe module from the non-working channel to a known working channel (if possible). If the probe works on the known working channel, replace the probe module. If the problem still exists on the known working channel, remove the probe from the tank and bring it to the console. Connect it directly to the console (you will need a spare probe cable). If the Probe-Out Alarm clears with the probe wires connected directly to the console, then there is a problem with the field wiring.

13. Measure the resistance of the probe wiring from the probe end of the cable to its connections at the console. First disconnect the cable from the console and twist the two ends together. Then remove the connector from the probe canister. Measure the resistance across the two connector pins. The resistance should be low. It should equal (approximately) the cable manufacturer's single conductor resistance per foot times the length of the cable run times two:

- 14 AWG should measure 2.52 ohms/1000 feet
- 16 AWG should measure 4.02 ohms/1000 feet
- 18 AWG should measure 6.39 ohms/1000 feet

If the resistance is higher than the cable manufacturer's specification, either the cable is defective or there are poor connections between the console and the probe. If the resistance is within the cable manufacturer's specification, measure the resistance between one of the connector pins and the field wiring conduit to verify it is not shorted (this resistance should be very high [megohms to infinity]). If the cable is good, reconnect the cable at the probe and the console.

14. Verify that the probe riser is not magnetized. This can be accomplished by using a metal paper clip on a string. Dangle the paper clip suspended by a string into the probe riser to determine if the riser pipe is magnetized. If the paper clip is attracted to one side of the riser pipe, replace the riser (this is rare, but it has occurred).

Minimum Detected Fluid Levels

Table 9-2. Mag Probe Minimum Detected Fluid Levels

Circuit Code	Mag Probe Type	Leak Detect	Name Plate Color	Water Detect	4" Ethanol-Blended Gasoline Floats		4" Floats		3" Floats		2" Floats	
					Min. Fuel Level	Min. Water Level	Min. Fuel Level	Min. Water Level	Min. Fuel Level	Min. Water Level	Min. Fuel Level	Min. Water Level
Mag Probes - Form Number 8473												
C000	Std., 2 float	0.10 gph	Black	Yes	—	—	8"	0.75"	—	—	9.5"	0.75"
C001	Std., 2 float	0.20 gph	Red	Yes	—	—	8"	0.75"	—	—	9.5"	0.75"
D000	Std., Inv. only, 2 ft	None	Green	Yes	—	—	8"	0.75"	—	—	9.5"	0.75"
D001	Alt., 1 float	0.10 gph	Black	No	—	—	5"	—	—	—	7"	—
D002	Alt., 1 float	0.20 gph	Red	No	—	—	5"	—	—	—	7"	—
D003	Alt., Inv. only	None	Green	No	—	—	5"	—	—	—	7"	—
Mag Probes - Form Numbers 8463 & 8493												
D004	2 float	0.10 gph	Black	Yes	7.000"	0.38"	3.04"	0.63"	3.04"	0.63"	3.23"	.867"
D005	2 float	0.20 gph	Red	Yes	7.000"	0.38"	3.04"	0.63"	3.04"	0.63"	3.23"	.867"
D006	Inv. only, 2 ft	None	Green	Yes	7.000"	0.38"	3.04"	0.63"	3.04"	0.63"	3.23"	.867"
D007	1 float	0.10 gph	Black	No	—	—	0.985"	—	0.985"	—	3"	—
D008	1 float	0.20 gph	Red	No	—	—	0.985"	—	0.985"	—	3"	—
D009	Inv. only, 1 ft	None	Green	No	—	—	0.985"	—	0.985"	—	3"	—
Mag Probes - Form Number 8468												

Table 9-2. Mag Probe Minimum Detected Fluid Levels

Circuit Code	Mag Probe Type	Leak Detect	Name Plate Color	Water Detect	4" Ethanol-Blended Gasoline Floats		4" Floats		3" Floats		2" Floats	
					Min. Fuel Level	Min. Water Level	Min. Fuel Level	Min. Water Level	Min. Fuel Level	Min. Water Level	Min. Fuel Level	Min. Water Level
D021	Inv. only 2 ft	None	Blue	Yes	—	—	3.04"	0.63"	3.04"	0.63"	3.23"	0.867"
D022	Inv. only, 2 ft	None	Blue	Yes	—	—	3.04"	0.63"	3.04"	0.63"	3.23"	0.867"
D023	Inv. only, 1 ft	None	Blue	No	—	—	0.985"	—	0.985"	—	3"	—
D024	Inv. only, 1 ft	None	Blue	No	—	—	0.985"	—	0.985"	—	3"	—
Density Mag Probes - Form Number 8860												
D041	Mag- D	0.10 gph	Black	Yes	—	—	—	—	—	—	8.0"	0.87"
D042	Mag- D	0.20 gph	Red	Yes	—	—	—	—	—	—	8.0"	0.87"
D043	Inv only, Mag- D	None	Green	Yes	—	—	—	—	—	—	8.0"	0.87"

Mag Probe Channel Counts in Common Liquids

Table 9-3 below shows the normal operating range of channel counts for magnetostrictive probes in common liquids (fuels).

Table 9-3. Mag Probe Channel Counts in Common Liquids

Probe Length	Channel	Normal Count Range*
All Probes	C00 (No Water)	0 - 1500
4 Foot Probe	C01-C10	700 - 17040
5 Foot Probe	C01-C10	700 - 21300
6 Foot Probe	C01-C10	700 - 25560
7 Foot Probe	C01-C10	700 - 29820
7 Foot, 6 Inch Probe	C01-C10	700 - 31950
8 Foot Probe	C01-C10	700 - 34080
9 Foot Probe	C01-C10	700 - 38340
10 Foot Probe	C01-C10	700 - 42600

*Channels C06 - C10 are only updated when necessary. Therefore the counts for C01 - C05 will normally be different from the counts for C06 - C10. Channel counts outside of this range indicate a defective probe – replace probe.

10 Sensor Troubleshooting



This section contains suggested corrective actions for troubleshooting sensor problems.

Turn off, tag, and lockout power to the console before opening display door assembly!

Sensor Alarm Will Not Clear

Liquid or fuel in containment area.

Sensor Out Alarms

Follow these steps in sequence to troubleshoot Sensor Out alarms.

1. Verify that the distance from the sensor to the TLS is less than 1000 feet.
2. Verify that the sensor wiring conforms to the requirements detailed in the [Site Prep and Installation Manual](#) (P/N 577014-073) and that it connects the console to the sensor.
3. Verify that the console grounding is correct. Make sure there are two grounds and that one is at least a 12 AWG (or larger diameter) conductor. Check that the grounding conductors are properly connected to a good ground source. Measure the resistance to ground, it should be less than one ohm.
4. Verify that the console is on a separate circuit breaker with no shared branch circuits.
5. Verify that the sensor connects to the proper connector position and that polarity (required for some sensors) is maintained from the sensor to the console. If necessary, refer to the [Sensor Products Application Guide](#) (P/N 577013-750) for correct sensor/console compatibility and sensor specifications.
6. View the diagnostic screen for the problem sensor and search for information that may help you determine the root cause of the sensor's problem.
7. Consider directly connecting the sensor to the console to confirm a faulty sensor.

Setup Data Warning

This alarm could be posted by one of three setup errors:

1. A label for the sensor was not entered during setup.
2. The wrong sensor type was selected during setup.
3. The sensor was not configured during setup but the console measures a resistive value and determines a device is connected.

Unstable Sensor Readings

Unstable sensor readings may be the result of intermittent signals or electro-magnetic interference (EMI). Some causes of unstable sensor readings are discussed below.

1. Shielded cable was not used between the sensor and the console, or if it was, it was not grounded correctly. See the [Site Prep and Installation Manual](#) (P/N 577014-073) for installation requirements.
2. Extra wires (not connected to the console) in the sensor conduit. They should be removed.

3. Damaged wiring insulation exposing bare conductors to moisture in the conduit. This condition may also appear as readings showing lower than normal or the same reading, regardless of the state of the sensor.
4. Moisture causing the sensor wiring to short to the conduit. This can become evident after rainy wet weather or flooding. Measuring the resistance with a standard volt-ohm meter may not identify a short due to moisture.
5. Connect the sensor directly to the console to determine if the reading is still unstable. If it stabilizes, the problem is between the console and the sensor. If fluctuation continues with the sensor connected directly to the console, change the sensor.

Cleaning Fuel Contaminated Discriminating Sensors

DISCRIMINATING SENSORS 794380-320, -322, -350, -352

Sensors exposed to gasoline should be removed from the pan or sump, dried off, and be allowed to recover in a well-ventilated area for up to 7 days. Note: recovery time will vary depending on the ambient temperature and how long the sensor was exposed to fuel. Sensors exposed to diesel fuel must be soaked in Coleman® fuel for 30 minutes and be allowed to recover in a well-ventilated area for up to 7 days.

DISCRIMINATING SOLID-STATE SENSOR - OPTICAL (P/N 794380-343, -344)

To clean contaminated optical sensors, dip the sensor into a small container of alcohol and briefly swirl it around to rinse it off.

Sensor Troubleshooting

COMM ALARMS

1. The console cannot reliably communicate with the sensor. This could be caused by a poor wiring connection, faulty sensor, faulty USM module, or an electrically noisy line.
2. Connect the sensor directly to the console to troubleshoot field wiring, noisy line issues. If unit is ok, check wiring connections, wire conductivity, etc., to isolate the problem.

MAG SENSOR

1. Verify threshold parameters entered during setup for this sensor are correct.
2. Following the alarm upgrade delay period, if enabled, any designated Fuel, Water, High Liquid, and Low Liquid 'warnings' will change to 'alarms' - even if the liquid in the containment area is only at the warning level.
3. For a Sensor Fault Alarm the console is reading the Mag Sensor, but the readings are unstable. The problem could be the sensor itself (float missing, bad probe, etc.) or electrical noise on the line (similar to effects on mag probes).
4. An Install Alarm is posted if the Mag Sensor is not firmly resting on the bottom of the monitored pan/sump. Check that the sensor is installed correctly.

11 CSLD Troubleshooting

CSLD collects information during each idle time to form a highly accurate leak detection database. Since the database is being constantly updated, leak test results are always current. Periodic leak tests are performed using the best data from up to the previous 28 days, and test results are continuously updated as new data is gathered. Invalid data is discarded and only the best data is used to ensure accurate leak test results and fewer false alarms. Test results are provided automatically every 24 hours at 8:00 a.m.

CSLD Tank Limitations

All applications of CSLD should conform to the following installation guidelines.

MAXIMUM TANK CAPACITY

Single tank - 30,000 gallons

Manifolded tanks - 30,000 gallons per manifolded set (3 tanks maximum per set).

MONTHLY THROUGHPUT GUIDELINES

Table 11-1. Tank Capacity / Monthly Throughput Limitations*

Product	Tank Capacity				
	<10,000	12,000	15,000	20,000	30,000
Gasoline	200,000	200,000	200,000	150,000	100,000
Diesel	200,000	200,000	200,000	200,000	200,000

**Total capacity of manifolded tanks establishes the throughput restrictions for that product. Installations exceeding these limitations may not pass monthly tests.*

CSLD Block Diagrams

Figure 11-1 illustrates the CSLD decision process in block diagram form and Figure 11-2 diagrams the timing of events during a CSLD test.

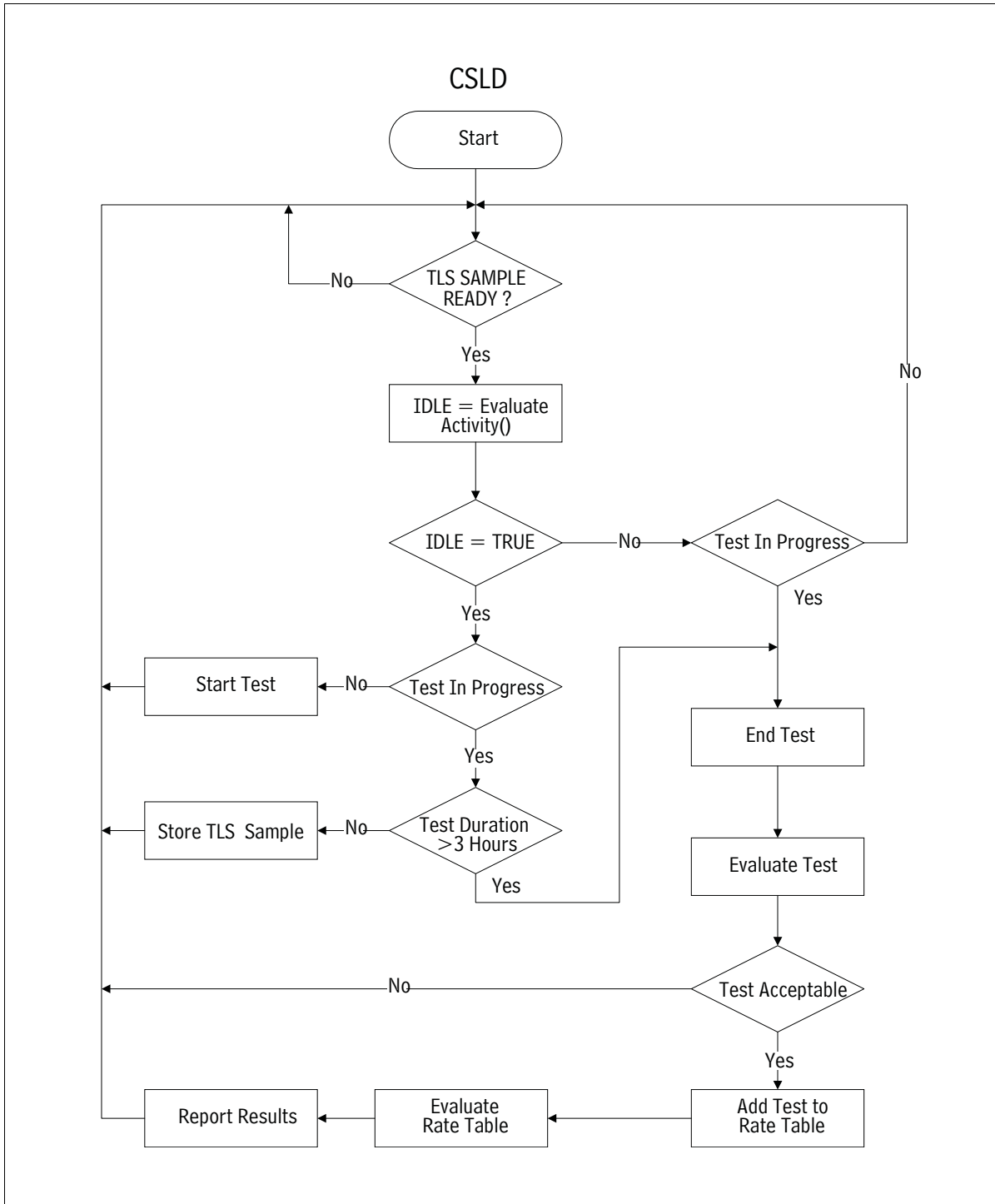

Figure 11-1. CSLD Decision Process Block Diagram

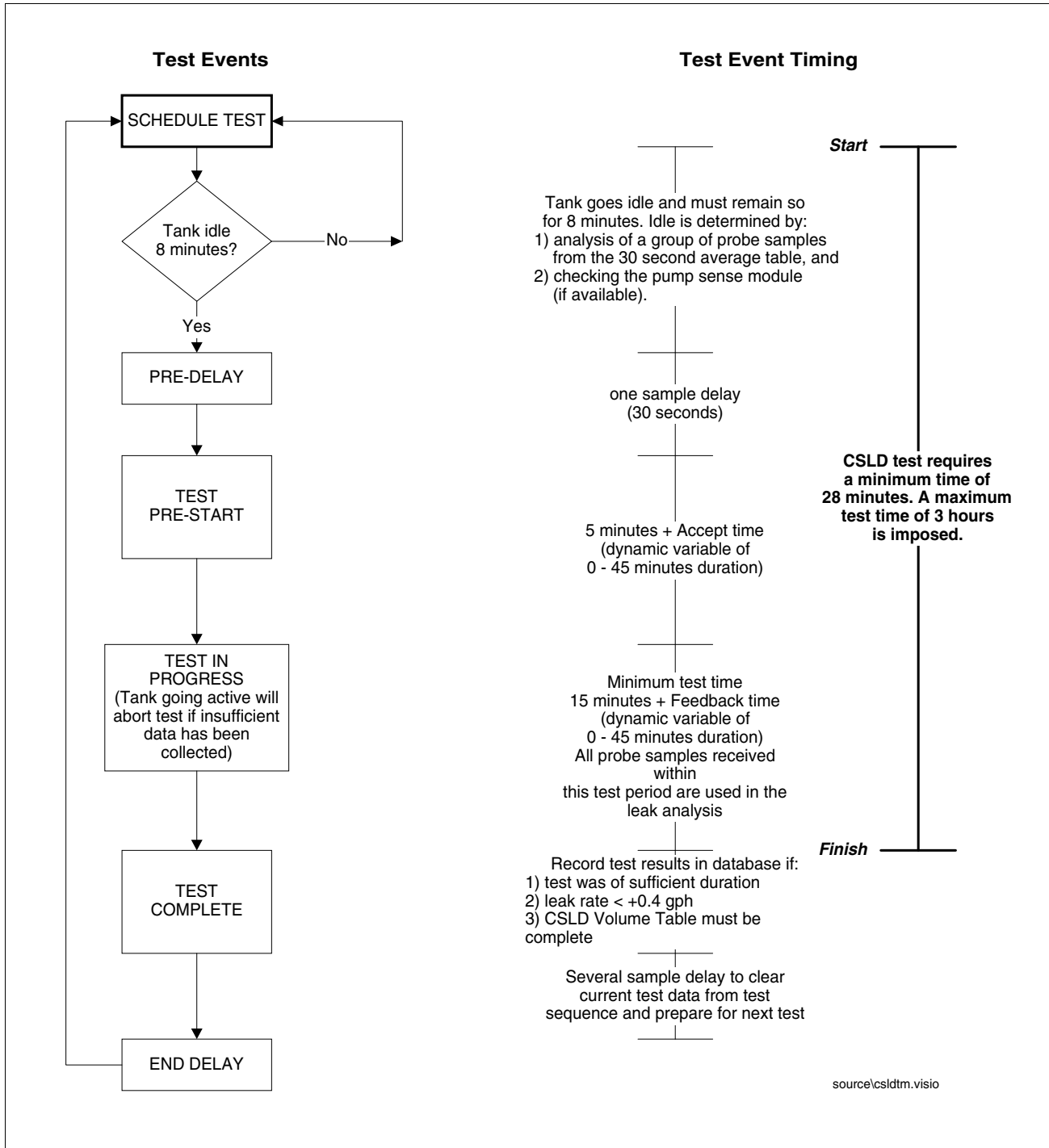

Figure 11-2. CSLD Leak Test Timing Sequence

CSLD Diagnostic Aids

Due to the complexity of CSLD, most information required to troubleshoot the product is accessible only using RS-232 commands via direct or modem connection. If you do not have a computer or data terminal to collect this data you will not be able to resolve CSLD alarms.

In order to troubleshoot CSLD problems you must retrieve the following reports via the RS-232 port or modem:

1. IA5100 - CSLD Rate Table (see Figure 11-3)

This table contains the last 28 days of leak tests, or a maximum of 80 of the most recent tests.

2. IA5200 - CSLD Rate Test (see Figure 11-4)

This report contains the CSLD summary of the evaluation of the raw test data collected in the Rate Table.

3. IA5300 - CSLD Volume Table (see Figure 11-5)

This report contains volume samples collected once every hour. CSLD uses this data to determine the amount of dispensing that has occurred during the last 24 hours.

4. IA5400 - CSLD Moving Average Table (see Figure 11-6)

This report contains averaged probe data collected every 30 seconds. CSLD uses this data to determine if the tank is idle or active, and to perform the leak test.

```

IA5100
MAR 14, 1996  8:12 AM

CSLD DIAGNOSTICS: RATE TABLE
T 1: SUPER
  TIME ST      LRT AVTMP TPTMP BDTMP  TMRT DSPNS  VOL INTVL  DEL ULLG EVAP
9602202227  0 -0.016 39.2 38.3 36.3 0.02  191 4281 174.5  2.7 168 0.000
9602210128  0  0.016 39.3 38.2 35.9 0.02  169 4281 174.5  5.7 168 0.000
9602210428  0 -0.022 39.4 38.2 35.6 0.03  162 4281  57.5  8.7 168 0.000
9602210636  1  0.106 39.5 38.3 35.8 0.02  213 4207  19.5 10.8 172 0.000
9602210718  1  0.118 39.5 38.4 35.9 0.00  215 4175  19.5 11.5 173 0.000
9602212259  3  0.007 40.2 39.0 37.1 0.02  460 3557 174.5 27.2 204 0.000

----- Partial set of entries shown -----

TIME      Test start time. (YYMMDDHHMM)

ST        Test qualification status at last evaluation.
          0 Test valid
          1 Test rejected - duration too short.
          2 Test rejected - start time too close to a delivery.
          3 Test rejected - excessive dispensing prior to test.
          4 Test rejected - excessive temperature change during test.
          6 Test rejected - leak rate outlier.

LRT       Leak rate in gph (negative number = a loss, no sign = a gain)

AVTMP     Average fuel temperature

TPTMP     Temperature of top thermistor in the tank.

BDTMP     Temperature of thermistor on the board.

TMRT      Rate of temperature change during the test.

DSPNS     Factor related to the amount of dispensing prior to the test.

VOL       Volume at the start of the test.

INTVL     Test Duration in minutes.

DEL       Time since the last delivery in hours.

ULLG     Amount of surface area of the tank that is not covered by fluid.

EVAP     If the Reid Vapor Pressure table has been entered, the evaporation rate will
          be here.

```

Figure 11-3. CSLD Rate Table Example

```

IA5200
MAR 14, 1996  8:12 AM

CSLD DIAGNOSTICS: RATE TEST

TK      DATE  LRATE INTVL ST  AVLRTE   VOL  C1  C3  FDBK ACPT  THPUT EVAP  RJT
1  9603140346 -0.031 33.7  1   0.002  3525  74  15 38.3 28.9 31.63 0.000  0
2  9603140342  0.000 32.2  1   0.004  3184  74  15 38.3 28.9 29.85 0.000  0
3  9603140151  0.051 26.8  1   0.039  6165  49  16 10.1  8.8 43.67 0.000  0
4  9603140646 -0.000 53.0  1  -0.003  1762  80  26 45.0 44.8 20.22 0.000  0

DATE      The date of the last rate table evaluation (YYDDMMHHMM)
LRATE     Compensated leak rate in gph (negative number = a loss, no sign = a gain)
INTVL     Total test duration, sum of all acceptable tests, in hours.
ST        Status:
          0 NO TEST - no evaluation.
          1 PASS
          2 FAIL
          3 NOT USED.
          4 INVALID - obsolete.
          5 NO DATA:COUNT - not enough tests available to evaluate. There must be
            at least 2 acceptable tests.
          6 NO DATA:INTERVAL - not enough total test time to evaluate (< 6 hours).
          7 NO DATA:RANGE - tests did not range over a sufficient time period.
            test time < 10 hours AND tests date range < 5 DAYS.
          8 WARNING INCREASE - excessive positive leak rate.
          9 WARNING NEGATIVE_HOLD - 2 day waiting period before reporting a
            failure.

AVLRTE    Uncompensated Leak Rate, in gph (negative number = a loss, no sign = a gain)
VOL       Average volume of all acceptable tests.
C1        Total number of tests in the rate table.
C3        Number of acceptable tests.
FDBK     Feedback control variable, range 0 to 45 minutes.
ACPT     Accept control variable, range 0 to 45 minutes.
THPUT    Estimated monthly throughput in thousands of gallons.
EVAP     If the Reid Vapor Pressure table has been entered, the evaporation rate will
          be here.
RJT      Of the last 20 tests completed, this is the number of tests rejected due
          to excessive positive leak rate (>0.4 gph).

```

Figure 11-4. CSLD Rate Test Example

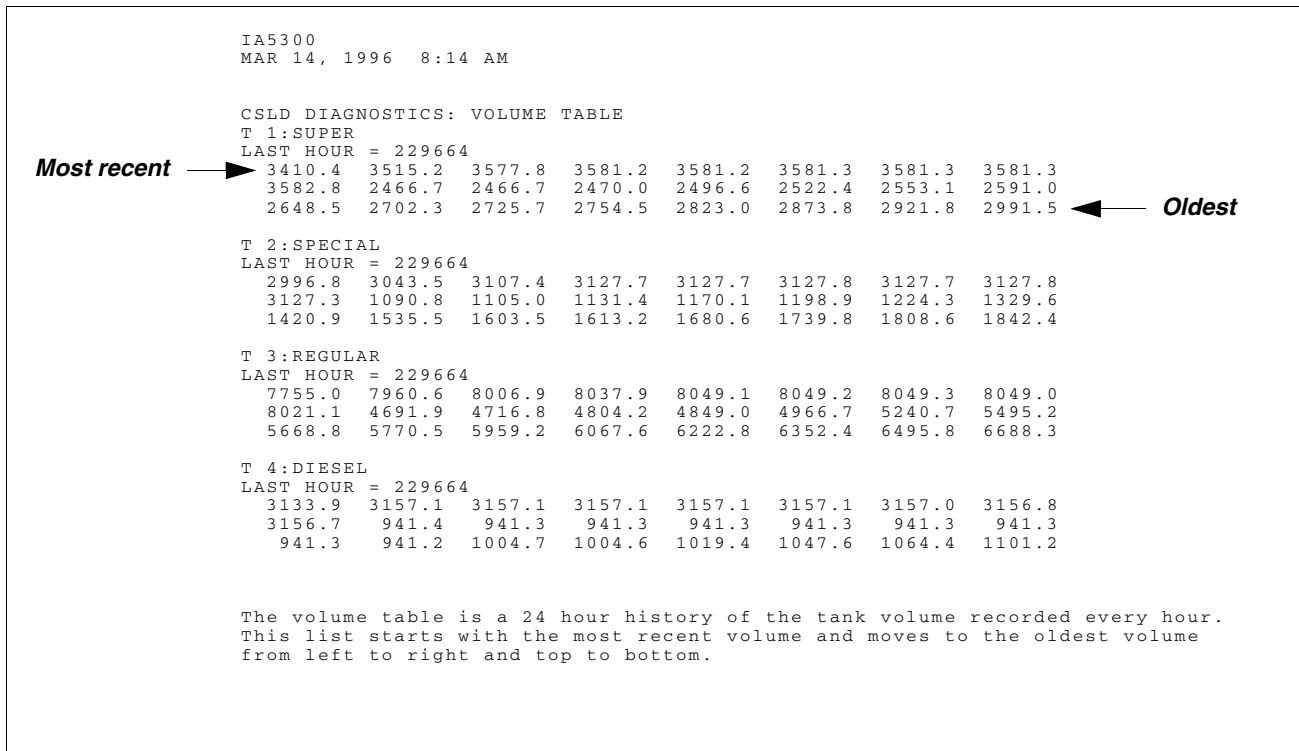

Figure 11-5. CSLD Volume Table Example

```

IA5402
MAR 12, 1996 10:52 AM

CSLD DIAGNOSTICS: MOVING AVERAGE TABLE

T 2: SUPER
TIME  SMPLS  TCVOL  HEIGHT  AVGTEMP  TOPTEMP  BDTEMP
960312103008  28  2118.16  29.547  45.52  44.01  39.31
960312103038  28  2118.16  29.547  45.52  44.01  39.31
960312103108  28  2118.14  29.547  45.52  44.01  39.31
960312103138  27  2118.16  29.547  45.53  44.02  39.32
960312103208  24  2118.17  29.547  45.53  44.02  39.32
960312103238  28  2118.19  29.547  45.52  44.02  39.32
960312103308  28  2118.13  29.547  45.52  44.02  39.32
960312103338  28  2118.13  29.547  45.52  44.02  39.33
960312103408  28  2118.16  29.547  45.52  44.03  39.33
960312103438  28  2118.13  29.547  45.52  44.03  39.33
960312103508  28  2118.17  29.547  45.52  44.03  39.33
960312103538  27  2118.16  29.547  45.52  44.04  39.34
960312103608  22  2118.21  29.547  45.52  44.04  39.34
960312103638  19  2118.16  29.547  45.52  44.04  39.34
960312103708  28  2118.23  29.548  45.52  44.05  39.34
960312103738  28  2118.19  29.547  45.52  44.05  39.34
960312103808  29  2118.17  29.547  45.52  44.06  39.35
960312103838  21  2118.13  29.547  45.52  44.06  39.35
960312103908  29  2118.21  29.547  45.52  44.06  39.35
960312103938  28  2118.12  29.546  45.53  44.06  39.36
960312104008  28  2118.11  29.546  45.53  44.06  39.36
960312104038  28  2118.21  29.547  45.53  44.06  39.37
960312104108  29  2118.14  29.547  45.53  44.06  39.37
960312104138  27  2118.05  29.546  45.53  44.06  39.38
960312104208  29  2115.86  29.524  45.53  44.06  39.38
960312104238  28  2112.55  29.490  45.53  44.05  39.39
960312104308  28  2109.43  29.459  45.53  44.05  39.39
960312104338  28  2106.14  29.426  45.53  44.05  39.40
960312104408  28  2102.58  29.390  45.53  44.05  39.40
960312104438  27  2099.08  29.354  45.53  44.05  39.40
960312104508  28  2095.64  29.320  45.53  44.05  39.41
960312104538  29  2092.37  29.287  45.53  44.04  39.41
960312104608  22  2091.61  29.279  45.53  44.04  39.41
960312104638  28  2091.66  29.279  45.53  44.04  39.42
960312104708  27  2091.64  29.279  45.53  44.04  39.42
960312104738  28  2091.66  29.280  45.53  44.05  39.43
960312104808  28  2091.65  29.279  45.53  44.05  39.43
960312104838  28  2091.60  29.279  45.53  44.05  39.43
960312104908  28  2091.61  29.279  45.53  44.05  39.44
960312105008  23  2091.60  29.279  45.53  44.04  39.44
960312105038  29  2091.67  29.280  45.53  44.04  39.44
960312105108  29  2091.70  29.280  45.53  44.04  39.45
960312105138  21  2091.63  29.279  45.53  44.04  39.45
960312105208  28  2091.74  29.280  45.53  44.04  39.45
960312105238  29  2091.63  29.279  45.53  44.04  39.45
960312105308  29  2091.64  29.279  45.53  44.04  39.46
MOVING AVERAGE:  2091.64

DISPENSE STATE: ACTIVE * 330.710632
    
```

SMPLS = Samples
TCVOL = Temp. compensated volume
HEIGHT = Product height
AVGTEMP = Avg. fuel temperature
TOPTEMP = Temp. of the highest thermistor in the probe
BDTEMP = Temp. of the probe circuit board (in canister)

* following ACTIVE = Pump sense available

Figure 11-6. CSLD Moving Average Table Example

Tank Setup Check Before Troubleshooting

All in-tank setup data must be correct for CSLD to work properly. Setup data, such as manifolded status, pump sense tank assignment, and temperature coefficient of thermal expansion entries, should be verified before attempting troubleshooting procedures.

CSLD Alarms

Each of the three CSLD alarms, CSLD Rate Incr Warn, No CSLD Idle Time, and Periodic Leak Test Fail is discussed below. In addition, there is one CSLD status message, No Results Available, which is also discussed.

ALARM: CSLD RATE INCR WARN

A CSLD Rate Increase Warning indicates fluid is entering the tank during the leak test. This warning indicates a higher than acceptable positive increase in product calculated from the CSLD Rate Table. The threshold amounts are listed below.

Single tank configuration:

PD - 95% = -0.17 gph

PD - 99% = -0.16 gph

Manifolded Tank configuration:

PD - 95% = -0.16 gph

PD - 99% = -0.15 gph

From the Home Screen, touch the DIAG button, the Tank Test button and then the CSLD Rate Table tab to view the CLSD Rate Table results.

SOME POSSIBLE Causes of positive rate increases

1. Incorrect temperature coefficient entered during setup. Verify that the temperature coefficient of thermal expansion is set correctly according to the TLS Setup specifications listing for various product grades.
2. Manifold Tank Siphon Bar Leakage

Rate increases can occur in siphon manifolded tanks due to a leaking siphon system. Since the siphon piping is normally full of fuel this can become a source of rate increases. If the siphon does not hold, product will drain back slowly into the tanks during idle periods. The fuel from the siphon piping will increase the volume in the tank which will cause a CSLD rate increase warning. Test and repair the siphon system per the manufacturer's recommendations.

3. Leaks In Submersible Pumps
 - Around the packer O-ring.
 - At the threads of the two-inch pipe coming from the turbine motor.
 - The gasket between the turbine motor and mounting flange.
 - At any seal which would allow the column of fuel being held in the pump by the check valve to leak back slowly into the tank.
4. Manifolded tanks are programmed incorrectly in In-Tank setup.

Tanks in a manifolded set must be programmed as a set, and you must select **CSLD** as the Leak Test Frequency for each of the tanks.
5. Defective Line Check Valves

Fluid from the line piping leaking back into the tank through a defective Line Check Valve may cause a rate increase. Verify that the line piping holds pressure after pumping stops.

6. Thermal Expansion In The Lines

When the product temperature in the tank is lower than the ground temperature, product in the line will expand after dispensing. After pumping ceases the line check valve or pump check valve will maintain pressure in the line. As the ground warms the product in the line expands. This expansion causes a corresponding pressure increase in the line therefore the pressure relief valve opens. The relief valve, relieves this increased pressure by allowing fuel to flow back into the tank. The flow from the line back into the tank can be a source of rate increase warnings. Typically thermal expansion's impact on CSLD is short lived. However, in extreme cases thermal expansion can be a source of CSLD rate increase warnings. If thermal expansion is suspected as the source of CSLD rate increase warnings you should inspect the site layout to determine if it is susceptible to ex-

treme thermal expansion due to site specific conditions (i.e. shallow line depth combined with extreme temperatures, etc.).

7. Stage II Vapor Recovery System Related Problems

- Condensed vapors and liquid drawn into the vapor recovery system can leak back into the tank causing increases.
- Check with the manufacturer of the vapor recovery system about possible solutions such as the addition of a vapor pot to collect these condensed vapors.
- Have the Stage II vapor recovery system inspected and tested.
- Verify that liquid product in the vapor lines cannot drain directly back into the tank. A liquid trap can be installed. The product that collects in the trap can be siphoned back to the tank via the pump siphon system. This will prevent the introduction of liquid into the tank during idle periods.

8. Water Leaking into the Tank

- Water can leak into the tank and cause rate increase warnings.
- Check the water level in the tank.
- Monitor the tank for increasing water levels.
- Check the alarm history for prior water level alarms.

ALARM: NO CSLD IDLE TIME

The system has not detected an idle period in the last 24 hours. All tanks must have at the very least some short idle periods each day. CSLD needs to find an idle time to clear this alarm. This alarm will automatically clear when the system detects that at least one idle period has occurred (this does not require that a CSLD record get stored in the rate table).

Frequent or continuous NO CSLD IDLE TIME messages are an indication of a problem. Possible reasons for this message:

1. Very large leaks may look like a product dispense. If this occurs the system will post a NO CSLD IDLE TIME alarm since it appears that product is being continually dispensed from the tank. Stop all activities and run a Static Leak Test.
2. Very high activity. Tank capacity or throughput specifications are exceeding CSLD specifications.
3. Line leak detection is running the product pump during normally idle periods. Veeder-Root line leak equipment is designed to coordinate line testing and CSLD to prevent this disturbance however in some cases conflicts may arise.
4. The site may be having problems determining an idle period due to site specific equipment disturbing the tank level (e.g. vapor recovery equipment).
5. The pump is running continuously. Check for a defective product dispenser or pump relay that is keeping the pump turned On.
6. A defective probe will sometimes make the tank level appear as though it is changing continuously when it is actually stable. This can be determined by examining the CSLD Moving Average Table (IA5400 Command). This table displays the tank data at 30 second intervals. Increases and decreases of typically around 1 or 2 gallons when the tank is idle are indications that the probe may be the problem. Also verify the amount of samples the TLS is receiving from the probe -there should be at least 7 and as many as 31.

ALARM: PERIODIC LEAK TEST FAIL

This message is posted when CSLD data indicates a high probability that a tank is leaking. The threshold for this determination is shown below,

Single Tanks:

PD - 95% = -0.17 gph

PD - 99% = -0.16 gph

Manifolded Tanks:

PD - 95% = -0.16 gph

PD - 99% = -0.15 gph

Review the CSLD Rate Table leak rates (Leak Rate). If the rates are not consistent (-0.83, +0.06,-0.90, -0.62, etc.) most likely the tank is not leaking.

Possible reasons for this message:

1. Tank is leaking.
2. CSLD is not recognizing the start of a busy period soon enough. These conditions are caused by small and/or slow dispenses, as in the case of operation with blenders. The solution would be to install a Pump Sense Module.
3. An external device is periodically turning On the pump power. This usually results in large negative leak rates. A Pump Sense Module will solve this problem.
4. Coefficient of expansion programmed incorrectly.
5. Tank is manifolded but programmed incorrectly.
6. Excessive compensation. Check in the IA5200 report for excessive compensation by comparing the compensated value (LRATE) to the uncompensated value (AVLRTE). The most likely cause of excessive compensation is bad probe temperature readings.
7. Stuck floats. Install a collar on the probe shaft to prevent floats from entering riser.
8. Floats damaged or installed incorrectly.
9. A stuck relay is causing the pump to run continuously. This causes the fluid to heat up around the pump producing temperature compensation errors.
10. Excessive evaporation due to an air leak into the tank may be the cause of a periodic leak test failure. Check vapor recovery system, pressure vent cap, all tank sump areas and riser caps, delivery sump plunger valve, etc.

STATUS MESSAGE: NO RESULTS AVAILABLE

This message may print when the CSLD Test Results are printed or accessed via the RS-232 command. This message indicates that CSLD has not collected sufficient test data to determine whether or not the tank is leaking, and is normal until 7 -10 days AFTER a CSLD startup. The program must be allowed to build a suitable database to calculate reliable results. At highly active sites some tanks may provide results before others. The busier tanks will take longer to produce the initial results.

Possible reasons for this message:

1. Not enough time after startup to generate results.
2. Console is being shut Off on a regular basis.
3. Tank too busy.

4. Defective probe.
5. Not enough idle time (see message above).
6. Tests are being rejected because the test results indicate a rate increase $>+0.4$ gph.

Static Leak Test

If after troubleshooting the Periodic Leak Test Fail Alarm an equipment problem has not been identified, perform a static leak test. Be sure that the product pump cannot come on during the test and that the level in the tank is within the normal operating range (i.e., the results of the static test may not be meaningful if the tank is nearly empty). If the static test verifies the CSLD result follow the procedures as established by the site owner. If the static test passes, contact Technical Support for assistance.

When to Manually Clear the CSLD Rate Table

You should manually clear the CSLD Rate Table if data, known to be inaccurate, had been stored in the table and the source of the inaccurate data was subsequently removed (e.g., after making tank plumbing repairs).

The CSLD Rate Table can be cleared by touching the Clear Table button on the CSLD Rate Table tab screen, or via the RS-232 command shown below.



IMPORTANT! DO NOT CLEAR THE CSLD RATE TABLE UNLESS IT IS ABSOLUTELY NECESSARY. DATA CLEARED FROM THIS TABLE CAN NOT BE RECOVERED!

Function Code: 054
Function Type: Delete CSLD Rate Table
Command Format:
Display: <SOH>S054TT149
Computer: <SOH>s054TT149

NOTE:

1. TT - Tank number (command valid for single tank only).
2. 149 - Verification code.

Typical Response Message Display:

```
<SOH>
S05402149
JAN 1, 1997 8:03 AM
T2:PRODUCT 2      CSLD RECORDS DELETED
<ETX>
```

typical Response Message Computer:

```
<SOH>s054TTYMMDDHHMM&&CCCC<EXT>
```

NOTE:

1. YYMMDDHHmm - Current time of day
2. TT - Tank number
3. && - Data termination flag
4. CCCC - Message checksum.

Contacting Tech Support

If the CSLD problem cannot be resolved, retrieve the following data via the RS-232 port or SiteFax modem and contact Technical Support:

1. <Control-A> IA5100 CSLD RATE TABLE
2. <Control-A> IA5200 CSLD RATE TEST
3. <Control-A> IA5300 CSLD VOLUME TABLE
4. <Control-A> IA5400 CSLD MOVING AVERAGE TABLE
5. <Control-A> I10100 SYSTEM STATUS REPORT
6. <Control-A> I10200 SYSTEM CONFIGURATION REPORT
7. <Control-A> I11100 PRIORITY ALARM HISTORY
8. <Control-A> I11200 NON-PRIORITY ALARM HISTORY
9. <Control-A> I20100 INVENTORY REPORT
- 10.<Control-A> I20200 DELIVERY REPORT
- 11.<Control-A> I20600 TANK ALARM HISTORY REPORT
- 12.<Control-A> I25100 CSLD RESULTS
- 13.<Control-A> I60900 SET TANK THERMAL EXPANSION COEFFICIENT
- 14.<Control-A> I61200 SET TANK MANIFOLDED PARTNERS

Is tank assigned to a pump sense input or assigned to a line leak device?

If assigned to a pump sense collect the following reports:

1. <Control-A> I77100 PUMP SENSE CONFIGURATION REPORT
2. <Control-A> I77200 PUMP SENSOR TANK ASSIGNMENT REPORT
3. <Control-A> I77300 PUMP SENSOR DISPENSE MODE REPORT
4. <Control-A> IB7100 PUMP SENSOR DIAGNOSTIC REPORT

OR - if assigned to PLLD collect the following report:

1. <Control-A> I78000 PRESSURE LINE LEAK GENERAL SETUP INQUIRY

Actual CSLD Test Problems Analyzed

CSLD PROBLEM 1 - TANK 1 CSLD FAIL

Report I25101 confirmed the failure. Reports IA5201, and IA5100 were then collected for analysis.

I25101

CSLD TEST RESULTS

TANK	PRODUCT	RESULT
1	SUPER	PER: JUL 26, 1996 FAIL

DIAGNOSTICS

JUL 26, 1996 10:44 AM

IA5101

CSLD DIAGNOSTICS: RATE TABLE

T1: SUPER

	TIME	ST	LRT	AVTMP	TPTMP	BDTMP	TMRT	DISPNS	VOL	INTVL	DEL	ULLG	EVAP
9606280418	1	0.105	66.1	75.3	84.8	-0.05	750	2837	35.5	51.9	263	0.000	
9606290312	3	0.059	69.3	76.4	86.3	-0.09	488	3542	127.5	5.0	227	0.000	
9606281743	1	0.095	68.8	77.0	86.8	-0.08	731	2802	36.0	19.5	265	0.000	
9606300041	3	-0.212	74.0	78.6	87.7	-0.15	432	4432	49.5	5.5	179	0.000	
9606300246	1	0.098	73.8	78.7	87.8	-0.13	441	4381	33.0	7.6	182	0.000	
9606300353	3	0.097	73.6	78.8	87.8	-0.12	438	4366	52.5	8.7	183	0.000	
9606300519	1	0.079	73.5	78.8	87.8	-0.11	434	4352	36.0	10.1	184	0.000	
9606300657	3	0.055	73.4	78.9	87.8	-0.11	4180	4316	53.5	11.8	186	0.000	
9607010127	3	0.070	72.4	79.9	89.5	-0.10	633	3464	39.5	30.3	231	0.000	
9607010240	3	0.047	72.3	79.9	89.6	-0.10	600	3458	44.0	31.5	231	0.000	
9607020111	1	0.050	71.4	79.5	90.2	-0.05	490	4492	32.0	16.5	176	0.000	
9607020303	1	0.067	71.3	79.6	90.2	-0.05	474	4467	26.0	18.4	178	0.000	
9607021054	1	0.092	70.7	80.2	89.7	-0.05	519	4196	25.5	26.2	193	0.000	
9607021900	1	0.105	70.9	80.5	89.8	-0.07	568	3837	35.0	34.3	212	0.000	
9607030105	3	0.069	71.0	80.7	89.8	-0.08	616	3580	41.5	40.4	225	0.000	
9607030222	3	0.002	70.9	80.7	89.7	-0.06	532	3571	113.0	41.7	226	0.000	
9607040407	1	-0.175	69.5	78.0	88.6	0.08	377	4297	34.0	0.9	187	0.000	
9607041719	3	0.092	69.7	79.8	88.0	-0.05	679	3574	42.0	14.1	226	0.000	
9607042049	3	0.052	69.8	79.8	88.3	-0.02	674	3448	43.5	17.6	232	0.000	
9607042330	3	0.010	69.8	79.8	88.3	-0.04	566	3423	113.5	20.3	233	0.000	
9607050208	3	0.042	69.7	79.8	88.3	-0.05	558	3403	39.5	23.0	234	0.000	
9607050323	3	0.002	69.7	79.7	88.2	-0.03	484	3398	99.5	24.2	235	0.000	
9607052355	3	0.062	72.6	79.8	88.6	-0.06	534	4442	78.5	11.8	179	0.000	
9607060152	3	0.040	72.5	79.9	88.7	-0.05	492	4416	146.0	13.8	180	0.000	
9607061838	3	0.095	72.0	80.8	89.1	-0.07	560	3832	37.0	30.5	212	0.000	
9607062238	1	-0.195	72.2	72.6	89.0	0.09	121	5631	28.5	0.0	97	0.000	
9607070235	1	0.022	72.5	74.8	89.4	0.01	208	5511	35.0	4.0	108	0.000	
9607070414	3	-0.454	72.6	75.3	89.4	0.00	209	5502	42.5	5.6	108	0.000	
9607080224	3	-0.004	72.5	80.9	90.7	-0.05	614	4585	104.0	27.8	171	0.000	
9607080756	3	0.042	72.5	81.2	90.5	-0.05	650	4427	41.5	33.3	180	0.000	
9607080923	0	-0.257	71.9	72.0	87.0	0.07	17	6027	147.0	34.8	0	0.000	
9607081224	0	-0.341	72.1	73.1	88.5	0.07	14	6026	146.5	3.0	0	0.000	
9607081524	0	-0.557	72.4	74.0	89.0	0.12	13	6025	146.5	6.0	0	0.000	

**Start of
bad data**

9607081825	0-0.356	72.7	75.1	89.4	0.07	10	6024	146.0	9.0	0	0.000
9607082126	0-0.306	72.9	76.1	89.7	0.06	7	6023	145.5	12.0	0	0.000
9607090027	0-0.296	73.1	76.7	89.8	0.05	6	6022	145.0	15.0	0	0.000
9607090329	0-0.359	73.2	77.3	89.7	0.09	5	6021	144.0	18.0	0	0.000
9607090630	0-0.429	73.6	78.4	89.4	0.09	4	6020	143.0	21.0	0	0.000
9607090931	6-0.737	73.9	79.5	89.2	0.16	5	6018	142.5	24.0	0	0.000
9607091233	0-0.448	74.3	80.4	89.0	0.10	6	6017	141.5	27.0	0	0.000
9607091534	0-0.187	74.5	80.8	88.9	0.05	5	6016	141.0	30.0	0	0.000
9607091835	0-0.393	74.7	81.1	88.8	0.08	5	6015	140.0	33.1	0	0.000
9607092137	0-0.080	75.1	81.5	88.7	0.02	5	6013	139.0	36.1	0	0.000
9607100038	0-0.034	75.1	81.5	88.5	-0.00	4	6013	138.5	39.1	0	0.000
9607100339	0-0.223	75.1	81.4	88.2	0.02	4	6013	137.5	42.1	0	0.000
9607100640	0 0.054	75.2	81.5	87.8	0.00	3	6013	137.0	45.1	0	0.000
9607100942	0-0.178	75.2	81.5	87.4	0.05	2	6013	136.0	48.1	0	0.000
9607101243	0-0.555	75.5	81.5	87.2	0.13	3	6012	135.5	51.1	0	0.000
9607101544	0-0.093	75.9	81.6	87.2	0.04	3	6010	135.0	54.1	0	0.000
9607101845	0-0.018	76.0	81.4	87.4	0.02	3	6010	134.5	57.1	0	0.000
9607102146	0-0.248	76.1	81.4	87.5	0.04	3	6009	134.0	60.1	0	0.000
9607110047	6 0.270	76.1	81.3	87.5	-0.06	2	6009	133.5	63.2	0	0.000
9607110348	0-0.115	76.0	81.2	87.4	0.04	2	6009	133.0	66.2	0	0.000
9607110649	0 0.113	76.1	81.1	87.1	-0.04	2	6009	44.5	69.2	0	0.000
9607120336	3-0.149	71.5	80.3	87.4	-0.05	1440	3214	75.5	15.9	244	0.000
9607130348	3-0.211	70.8	79.3	86.5	-0.02	587	3965	99.0	4.8	205	0.000
9607132344	3 0.054	70.9	79.9	87.5	-0.05	638	3110	51.5	24.7	249	0.000
9607140246	2 0.133	70.1	75.1	86.5	0.04	182	5030	128.5	0.1	144	0.000
9607150252	3 0.054	70.7	79.4	86.0	-0.03	638	4088	45.0	24.2	199	0.000
9607170151	1 0.019	72.8	79.6	86.3	-0.07	795	3756	29.0	36.7	216	0.000
9607170329	3 0.061	72.8	86.4	87.5	-0.07	732	3736	40.5	38.3	217	0.000
9607170752	1 0.055	72.8	79.8	86.5	-0.07	697	3593	18.5	42.7	224	0.000
9607172000	1 0.059	72.5	80.2	86.1	-0.05	614	3045	30.5	54.8	252	0.000
9607180638	1 0.029	72.8	80.4	84.7	-0.04	607	2665	18.0	65.5	271	0.000
9607190226	1 0.073	72.4	79.5	84.2	-0.02	700	3614	28.0	14.0	223	0.000
9607200059	3 0.024	73.1	79.5	84.8	-0.09	980	2230	38.0	36.6	294	0.000
9607200246	3 0.006	73.0	79.5	84.7	-0.08	882	2203	93.0	38.4	295	0.000
9607210433	3 0.033	71.6	78.6	84.6	-0.01	510	4222	48.0	17.4	191	0.000
9607210613	1 0.027	71.6	78.6	84.5	-0.02	493	4218	32.0	19.1	191	0.000
9607220129	1 0.074	72.4	78.9	83.3	-0.08	637	3403	16.0	38.3	234	0.000
9607220323	3-0.011	72.3	78.9	83.1	-0.04	563	3380	54.5	40.2	235	0.000
9607220828	1 0.107	72.4	78.8	82.6	-0.07	604	3219	16.0	45.3	243	0.000
9607232310	1 0.045	72.7	78.4	83.9	-0.06	644	3525	21.0	32.6	228	0.000
9607240105	1 0.066	72.7	78.4	84.0	-0.06	620	3471	21.5	34.5	230	0.000
9607250248	1 0.094	72.0	78.5	85.1	-0.05	654	3301	20.5	18.4	239	0.000
9607250641	1 0.003	72.1	78.6	84.9	-0.04	620	3219	17.5	22.3	243	0.000
9607260126	3 0.009	72.3	78.9	85.3	-0.07	793	2153	78.5	41.0	298	0.000
9607260336	3-0.024	72.2	78.9	85.2	-0.06	732	2145	63.0	43.2	298	0.000

**End of
bad data**

IA5201

CSLD DIAGNOSTICS: RATE TEST

TK	DATE	LRATE	INTVL	ST	AVLRTE	VOL	C1	C3	FDBK	ACPT	THPUT	DFMUL	RJT
1	9607260947	-0.308	49.8	2	-0.259	6016	79	22	43.9	43.4	5.24	-0.40	0

ANALYSIS OF RATE TABLE (IA51)

LRT

Looking in the leak rate column (LRT) the test results start off looking reasonable, if anything they tend to be positive. Leak rates suddenly change on the 8th and are consistently negative. There is another transition on the 13th where the leak rates return to the pattern observed prior to the 8th - slightly positive.

ST

the status table indicates that the tests between the 8th and 13th are the only ones contributing to the overall leak rate. This is indicated by a status code of 0. The reason CSLD is favoring these tests will be explained below.

DATE

The DATE field indicated that tests are being performed on a regular basis, several tests a day.

CSLD will complete a test after 3 hours and start a new test if the tank remains idle. The tests between the 8th and the 13th are being performed continuously, one test every 3 hours. This is inconsistent with the tests outside this date range.

INTVL

This is the length of a test in minutes. With the exception of the period between the 8th and 13th, test lengths are much less than 140 minutes. this indicates the site is a 24-hour site because tests are halted by dispensing, not the 3-hour CSLD limit. Test intervals are less than 3 hours because CSLD eliminates the first part of a test. The amount of time eliminated varies with the feedback variables.

Together, the interval and date information indicates that the tank was IDLE during the 8th and 13th period.

In reference to all the test in the rate table, these tests also have the longest interval time, one of the reasons CSLD is favoring these tests. All the tests with status code 1 were rejected due to short intervals.

DSPNS

The dispense factor is an indication of the amount of dispensing that occurred during the last 24 hours. It is not as simple as the amount of gallons dispensed during the last 24 hours because the hourly volumes are weighted in such a way that the most recent dispensing value contributes more to the dispense factor than dispensing volume that has occurred 23 hours ago. But it can be used as a relative indication of tank activity. The dispense factor for the above data set shows a typical value of 600. But the dispense factor during the 8th and 13th period drops rapidly to single digit values. This is another indication that there was no dispensing during this period.

CSLD prefers tests with low dispense factors, another reason why CSLD is favoring these tests. All the tests rejected with error code 3 were rejected because of high dispense factors.

VOL

The volume parameter indicates the volume at the start of the test. The volume during the trouble period started at 6027 and slowly dropped to 6009 gallons. Note that none of the volumes exceeded 6027.

EVAP

If the Reid Vapor Pressure table has been entered, the evaporation rate is displayed here.

DEL

The time since last delivery is in hour units. There was no indication of a delivery during the problem period. All tests rejected with error code 2 started within 2 hours of a delivery.

ULLG

The ullage factor is the surface area of the walls of the tank that is NOT covered in fluid. It is used for leak rate compensation. This parameter normally provides little diagnostic value, but it actually solves the problem. An ullage factor of zero indicates the tank is completely full, i.e., fluid height is equal to or greater than the tank's diameter.

ANALYSIS OF RATE TEST (IA52)

The average leak rate (AVLRTE) is -0.259. The average leak rate is uncompensated so excessive compensation is not an issue. This leak rate is not excessively high so blender/pump sense issues are probably not involved.

The tank label is SUPER so most likely it is not manifolded.

The DATE is recent so results are up to date.

The maximum number of tests is 80 and because C1 = 79 there are more than enough tests.

SOLUTION

The float was stuck in the riser. A collar was installed on the probe to prevent recurrences of this problem.

CSLD PROBLEM 2 - MANIFOLDED TANKS 1 AND 2 ARE FAILING

Reports I201, I51, IA52, and I752 were collected for analysis.

DIAGNOSTICS

I20100

STATION HEADER INFO

MAY 21, 2000 10:29 AM

TANK	PRODUCT	VOLUME	TLC	VOLUME	ULLAGE	HEIGHT	WATER	TEMP
1	REGULAR	2311		2303	3705	39.21	0.0	65.2
2	REGULAR SLAVE	3276		3266	4746	41.07	1.6	64.1
3	MIDGRADE	4378		4365	5774	42.81	0.0	64.4
4	PREMIUM	2547		2548	7605	28.68	1.3	59.7

IA5200

JUN 11, 2000 12:00 PM

CSLD DIAGNOSTICS: RATE TEST

TK	DATE	LRATE	INTVL	ST	AVLRTE	VOL	C1	C3	FDBK	ACPT	THPUT	EVAP	RJT
1	9608220320	-0.834	28.4	2	-0.809	7909	58	30	20.3	21.7	32.37	0.000	0
2	9608220320	-0.834	28.4	2	-0.809	7909	58	30	20.3	21.7	29.56	0.000	0
3	9608220445	-0.008	25.8	1	0.005	4400	67	18	30.	21.7	21.23	0.000	0
4	9608220402	0.005	22.3	1	0.005	1893	80	13	45.0	44.8	24.45	0.000	0

I75200

JUN 11, 2000 10:30 AM

LINE LEAK TANK ASSIGNMENT

LINE	LABEL	TAN
1	PREMIUM	4
2	MIDGRADE	3
3	REGULAR	1

Line 1 should be labelled Regular and assigned to tank 1
Correct as is
Line 3 should be labelled Premium and assigned to tank 4

I510

AUG 22, 1996 11:58 AM

CSLD DIAGNOSTICS: RATE TABLE

T1: REGULAR

Large and inconsistent negative leak rates.

TIME	ST	LRT	AVTMP	TPTMP	BDTMP	TMRT	DISPNS	VOL	INTVL	DEL	ULLG	EVAP
9607250359	1	-0.802	72.3	73.7	76.0	-0.09	594	5214	20.0	36.3	602	0.000
9607260145	3	-0.186	73.5	74.3	76.2	-0.15	451	9019	25.0	0.6	443	0.000
9607260309	0	-0.661	73.3	74.3	76.2	-0.12	438	9005	28.5	2.0	444	0.000
9607270309	0	-0.666	72.4	73.5	76.2	-0.04	602	11409	29.5	3.4	331	0.000
9607270411	0	-0.409	72.4	73.6	76.2	-0.04	552	11407	55.5	4.4	331	0.000
9607280030	0	-1.027	72.2	73.9	76.2	-0.05	503	9725	39.5	24.8	413	0.000
9607280318	0	-1.064	72.1	73.9	76.2	-0.05	448	9688	74.5	27.6	414	0.000
9607280511	0	-0.634	72.1	73.8	76.2	-0.04	410	9671	57.0	29.5	415	0.000
9607290118	1	-0.544	71.9	73.9	76.3	-0.07	478	8065	25.0	49.6	483	0.000
9607290408	0	-0.932	71.8	73.8	76.3	-0.05	434	8032	33.0	52.4	485	0.000
9607300100	0	-1.121	71.7	73.6	76.2	-0.07	601	5827	84.5	73.3	577	0.000
9607300258	0	-0.873	71.5	73.6	76.2	-0.07	551	5815	119.0	75.3	577	0.000
9607310325	2	-0.621	70.3	72.7	76.0	0.02	468	10592	29.5	1.8	373	0.000
9607310427	0	-0.388	70.4	72.8	76.0	0.01	431	10589	43.0	2.8	373	0.000
9608010046	6	-0.081	70.3	71.8	75.6	0.00	509	11824	138.5	2.1	309	0.000
9608010451	1	-0.521	70.3	72.4	75.5	0.00	481	11804	22.5	6.2	310	0.000
9608020130	3	-0.839	70.6	73.1	75.4	-0.04	689	9208	107.5	26.9	436	0.000
9608020349	0	-0.597	70.5	73.1	75.3	-0.04	663	9202	48.5	29.2	436	0.000
9608020510	1	-1.061	70.5	73.1	75.3	-0.03	639	9191	17.0	30.5	437	0.000
9608030035	1	-0.775	70.8	72.9	75.1	-0.06	783	6543	15.0	49.9	546	0.000
9608030351	3	-0.951	70.7	72.9	75.1	-0.06	680	6448	68.0	53.2	551	0.000
9608040234	3	-0.839	72.8	73.7	75.1	-0.08	988	8570	55.5	12.4	463	0.000
9608040425	1	-0.046	72.7	73.9	75.1	-0.05	944	8567	16.0	14.3	462	0.000
9608040649	1	-0.144	72.6	73.7	75.1	-0.07	842	8514	21.0	16.6	465	0.000
9608050051	0	-0.228	72.3	73.4	75.2	-0.07	531	6661	81.5	34.7	541	0.000
9608050309	1	0.030	72.2	73.6	75.2	-0.09	509	6659	20.0	37.0	541	0.000
9608060123	0	-0.344	71.9	73.3	75.3	-0.10	617	4366	107.5	59.2	639	0.000
9608070046	3	-0.942	77.8	77.3	76.4	-0.20	684	9861	48.0	7.2	404	0.000
9608070312	1	-0.955	77.4	77.0	76.5	-0.17	647	9823	26.0	9.6	406	0.000
9608080356	0	-0.960	75.5	75.9	76.9	-0.10	654	7168	76.5	34.4	520	0.000
9608090121	0	-1.035	74.6	75.4	77.2	-0.11	614	4957	47.0	55.6	613	0.000
9608090315	1	-1.435	74.5	75.4	77.2	-0.10	599	4930	22.5	57.7	614	0.000
9608090410	0	-1.226	74.4	75.4	77.3	-0.09	577	4923	31.0	58.6	614	0.000
9608100145	1	-0.738	73.3	75.0	77.4	-0.06	713	7261	24.0	19.6	517	0.000
9608110220	1	0.132	72.5	74.0	77.4	0.00	420	11645	22.0	1.4	317	0.000
9608110445	0	-0.218	72.6	74.7	77.5	-0.01	372	11634	53.0	3.8	318	0.000
9608110616	0	-0.628	72.6	74.7	77.5	-0.01	362	11624	42.5	5.3	319	0.000
9608120303	2	-0.779	72.7	73.3	77.3	-0.02	302	12240	31.5	0.7	282	0.000
9608120409	2	-0.574	72.7	73.5	77.3	-0.03	293	12233	43.5	1.8	283	0.000
9608130138	0	-0.874	72.8	74.8	77.2	-0.04	580	10045	88.0	23.3	398	0.000
9608130342	1	-0.777	72.7	74.9	77.2	-0.04	560	10035	21.5	25.4	398	0.000
9608130520	1	-1.054	72.7	74.9	77.2	-0.04	547	10016	21.5	27.0	399	0.000
9608140210	0	-1.442	72.7	74.9	77.1	-0.05	565	8025	36.5	47.8	486	0.000
9608140328	0	-1.245	72.6	74.9	77.1	-0.05	523	8010	47.0	49.1	486	0.000
9608150117	3	-0.758	72.6	74.7	77.0	-0.08	690	5501	100.5	70.9	590	0.000
9608160325	2	-0.843	72.1	74.1	76.9	0.00	415	10443	53.0	1.7	380	0.000
9608160455	0	-0.594	72.1	74.3	77.0	0.00	398	10438	30.5	3.2	380	0.000
9608170055	0	-0.427	72.2	74.7	77.0	-0.06	630	8255	29.5	23.3	475	0.000
9608170403	0	-0.704	72.2	74.7	77.0	-0.04	551	8193	112.0	26.4	478	0.000
9608180200	0	-1.037	72.2	74.6	76.9	-0.06	504	6338	78.5	48.3	555	0.000

9608180357	0	-0.853	72.1	74.6	76.9	-0.05	486	6329	46.5	50.3	555	0.000
9608180523	0	-1.071	72.0	74.6	76.9	-0.05	452	6316	72.0	51.7	556	0.000
9608190359	2	-1.182	72.0	74.1	76.8	0.00	358	9680	62.0	1.7	414	0.000
9608200135	1	-0.385	72.2	74.6	76.8	-0.05	618	7471	22.5	23.3	508	0.000
9608220158	0	-1.139	71.6	74.5	76.7	-0.09	564	3210	41.5	71.6	694	0.000
9608220320	0	-1.284	71.5	74.5	76.7	-0.08	520	3194	40.0	73.0	695	0.000

CSLD DIAGNOSTICS: RATE TABLE

T2: REGULAR SLAVE

TIME	ST	LRT	AVTMP	TPTMP	BDTMP	TMRT	DISPNS	VOL	INTVL	DEL	ULLG	EVAP
RATE TABLE EMPTY												

The slave tank in manifolded sets will have empty rate tables!

Analysis of Rate Table (IA51)

Rate table shows large negative rates and the rates are inconsistent. This is an indication that CSLD is not detecting dispensing soon enough. If the leak test had stopped after dispensing began, the result would have been a negative rate.

The solution for this type of problem is pump sensing. BUT this site has pump sensing with line leak devices. The problem in this example was that the pump wiring to the line leak devices was correct, but the line leak tank assignments were incorrect.

Solution

Reassign Tanks 4 and 1 to their installed line leak devices (in this example, Line 1 [Reg] to Tank 1, Line 2 is correctly assigned to Tank 3, but Line 3 [Premium] should be assigned to Tank 4).

CSLD PROBLEM 3 - INCREASE RATE WARNING FOR MANIFOLDED TANKS 2 AND 3

Reports IA52 and IA53 were collected for analysis.

Diagnostics

IA5200
MAR 12, 1996 1:54 PM

Indicates number of tests rejected because leak rates > +0.4 gph.

CSLD DIAGNOSTICS: RATE TEST

TK	DATE	LRATE	INTVL	ST	AVLRTE	VOL	C1	C3	FDBK	ACPT	THPUT	DFMUL	RJT
1	9603121226	-0.033	28.6	1	-0.009	3877	80	20	45.0	44.8	1.42	-0.08	0
2	9603120523	0.138	36.8	1	0.165	8647	53	31	14.6	15.0	3.26	0.16	5
3	9603120523	0.138	36.8	1	0.165	8647	53	31	14.6	15.0	3.26	0.16	5

Large positive rates.

CSLD DIAGNOSTICS: RATE TABLE

T 2:REGULAR

TIME	ST	LRT	AVTMP	TPTMP	BDTMP	TMRT	DSPNS	VOL	INTVL	DEL	ULLG	EVAP
9602130541	1	0.181	42.2	41.7	40.1	-0.01	265	10628	20.5	23.9	304	0.000
9602140033	3	0.320	42.1	41.6	40.3	-0.00	457	9331	59.5	42.7	366	0.000
9602140318	1	0.285	42.1	41.6	40.4	-0.00	420	9304	21.5	45.5	366	0.000
9602140406	0	0.178	42.1	41.6	40.4	-0.00	386	9292	100.0	46.3	366	0.000

9602150326	0	0.144	42.1	41.6	40.9	-0.00	382	7994	76.0	69.6	415	0.000
9602160140	0	0.354	42.0	41.6	41.2	0.00	440	6451	86.5	91.8	469	0.000
9602160333	0	0.281	42.0	41.6	41.2	0.00	422	6446	30.0	93.7	469	0.000
9602160506	1	0.260	42.0	41.7	41.2	0.00	404	6434	9.0	95.3	469	0.000
9602160541	0	0.084	42.0	41.7	41.2	0.00	388	6428	44.5	95.9	469	0.000
9602170444	0	0.353	42.1	41.5	41.4	0.00	416	4840	77.0	118.9	526	0.000
9602190128	0	0.307	42.8	42.6	41.8	-0.01	287	11416	101.0	33.9	267	0.000
9602190335	0	0.072	42.8	42.6	41.8	-0.01	259	11411	123.0	36.0	267	0.000
9602200211	0	0.046	42.7	42.4	41.9	-0.00	357	10165	125.0	58.6	328	0.000
9602210256	0	0.169	42.7	42.3	41.9	-0.00	366	8726	132.0	83.3	383	0.000
9602210534	0	0.260	42.7	42.3	41.8	-0.00	351	8721	53.0	86.0	383	0.000
9602220139	3	0.153	42.6	42.2	41.9	-0.00	499	7285	63.0	106.1	444	0.000
9602220308	3	0.180	42.6	42.2	41.9	-0.00	479	7280	43.5	107.6	444	0.000

CSLD DIAGNOSTICS: RATE TABLE

T 3:REGULAR

TIME	ST	LRT	AVTMP	TPTMP	BDTMP	TMRT	DSPNS	VOL	INTVL	DEL	ULLG	THPT
------	----	-----	-------	-------	-------	------	-------	-----	-------	-----	------	------

RATE TABLE EMPTY

IA5300

IA5300

MAR 12, 1996 1:54 PM

T2 is not tracking T3 which indicates siphon is broken.

CSLD DIAGNOSTICS: VOLUME TABLE

T 2:REGULAR

LAST HOUR = 229621

3768.9	3844.8	3893.5	3938.7	3979.9	4002.5	4002.5	4003.3	<i>Volume is not moving.</i>
4003.4	4003.4	4003.3	4003.5	4003.1	4003.0	4003.5	4001.6	
<u>4003.8</u>	4024.6	4061.8	4109.2	4162.8	4253.6	4344.8	4346.6	

T 3:REGULAR

LAST HOUR = 229621

3473.6	3457.0	3487.6	3511.8	3537.1	3573.3	3609.7	3644.7	<i>Volume is moving.</i>
3649.7	3653.7	3655.9	3664.3	3670.7	3688.0	3746.6	3756.3	
<u>3796.1</u>	3831.2	3850.6	3914.6	3941.3	3923.1	3908.1	3999.2	

Analysis

The hourly volume table shows that the manifolded tanks are not always tracking. Compare the periods underlined in the volume table below (Tank 2 volume only moved 1.3 gals while Tank 3 volume moves 222.8 gals). This large difference indicates that the siphon is breaking. Fluid leaking into the tank from the siphon is causing the increase rate warning.

Solution

Repair siphon.

CSLD PROBLEM 4 - NO CSLD IDLE TIME

Report IA5402 was collected for analysis during an idle period (no dispensing/deliveries).

Diagnostics

IA5402

JUN 24, 1996 2:30 PM

CSLD DIAGNOSTICS: MOVING AVERAGE TABLE

T 2: MIDGRADE

Excessive differences may indicate a defective probe.

TIME	SMPLS	TLCVOL	HEIGHT	AVGTEMP	TOPTEMP	BDTEMP
960624140631	31	6521.67	53.299	78.76	81.10	86.64
960624140701	31	6521.77	53.298	78.72	80.99	86.54
960624140731	31	6521.85	53.297	78.67	80.88	86.44
960624140801	31	6522.22	53.298	78.61	80.75	86.34
960624140831	31	6522.67	53.298	78.53	80.62	86.23
960624140901	31	6523.02	53.298	78.46	80.49	86.11
960624140931	31	6523.44	53.299	78.38	80.35	85.94
960624141001	31	6523.48	53.297	78.30	80.17	85.81
960624141031	31	6523.90	53.297	78.22	80.04	85.67
960624141101	31	6524.77	53.301	78.15	79.93	85.84
960624141131	31	6524.58	53.298	78.11	79.84	85.41
960624141201	31	6525.14	53.301	78.09	79.77	85.28
960624141231	31	6524.94	53.299	78.08	79.71	85.15
960624141301	31	6524.97	53.299	78.06	79.66	85.03
960624141331	30	6525.22	53.300	78.04	79.62	84.91
960624141401	32	6525.17	53.299	78.02	79.57	84.79
960624141431	30	6525.26	53.299	77.98	79.51	84.68
960624141501	32	6525.63	53.299	77.93	79.24	84.52
960624141531	31	6526.39	53.302	77.68	79.33	84.40
960624141601	31	6526.71	53.303	77.80	79.26	84.29
960624141631	31	6526.88	53.302	77.74	79.20	84.17
960624141701	31	6527.34	53.304	77.72	79.17	84.07
960624141731	31	6527.60	53.306	77.73	79.17	83.97
960624141801	31	6527.49	53.308	77.81	79.27	83.89
960624141831	30	6527.37	53.311	77.93	79.43	83.85
960624141901	32	6526.21	53.307	78.05	79.62	83.82
960624141931	31	6526.36	53.311	78.16	79.78	83.81
960624142001	31	6525.02	53.305	78.23	79.94	83.81
960624142031	31	6525.20	53.307	78.26	80.00	83.81
960624142101	31	6524.84	53.304	78.25	80.01	83.80
960624142131	30	6523.02	53.304	78.25	80.00	83.80
960624142201	32	6526.39	53.314	78.23	80.04	83.79
960624142231	31	6526.65	53.319	78.35	80.19	83.81
960624142301	31	6525.05	53.315	78.57	80.45	83.86
960624142331	30	6523.43	53.319	78.84	80.78	83.94
960624142401	29	6521.88	53.310	79.11	81.12	84.05
960624142431	31	6519.58	53.303	79.34	81.44	84.17
960624142501	31	6519.59	53.308	79.53	81.69	84.35
960624142531	30	6518.62	53.304	79.60	81.84	84.47
960624142601	32	6518.72	53.305	79.59	81.90	84.58
960624142631	30	6519.02	53.305	79.53	81.89	84.67
960624142701	31	6519.54	53.305	79.43	81.78	84.73
960624142731	31	6520.18	53.307	79.35	81.70	84.78
960624142801	31	6520.59	53.308	79.31	81.66	84.83
960624142831	31	6519.95	53.305	79.33	81.68	84.88
960624142901	30	6519.45	53.304	79.41	81.79	84.95

MOVING AVERAGE: 6523.52

DISPENSE STATE: ACTIVE * 177.531143

Analysis

The moving average table shows erratic probe readings. Fluid is rising and falling by several gallons.

Solution

Replace probe.

CSLD PROBLEM 5 - TANK 1 IS FAILING

Reports I251, I201, IA52, IA51, and I609 were collected for analysis.

Diagnostics

I25100
 JUN 26, 1996 2:37
 STATION
 HEADER
 INFO
 PHONE

CSLD TEST RESULTS

TANK	PRODUCT	RESULT
1	UNLEADED	PER: JUN 24, 1996 FAIL
2	UNLEADED PLUS	PER: JUN 26, 1996 PASS
3	SUPER UNLEADED	PER: JUN 26, 1996 PASS
4	KEROSENE	PER: JUN 26, 1996 PASS
5	DIESEL	PER: JUN 26, 1996 PASS

I20100
 STATION HEADER INFO
 JUN 26, 1996 2:36 PM

TANK	PRODUCT	VOLUME	TLC VOLUME	ULLAGE	HEIGHT	WATER	TEMP
1	UNLEADED	8627	8617	3000	63.42	0.0	76.9
2	UNLEADED PLUS	9286	9278	2341	67.92	0.0	72.2
3	SUPER UNLEADED	8315	8309	3312	61.38	0.0	70.6
4	KEROSENE	5399	5395	598	60.21	0.0	70.9
5	DIESEL	2989	2987	2940	46.27	0.0	70.1

IA5200
 JUN 26, 1996 2:37 PM

CSLD DIAGNOSTICS: RATE TEST

TK	DATE	LRATE	INTVL	ST	AVLRTE	VOL	C1	C3	FDBK	ACPT	THPUT	EVAP	RJT
1	9606240446	-0.270	10.3	2	-0.217	6406	21	20	0.0	0.0	44.32	0.000	1

2	9606260806	-0.159	25.1	1	-0.140	8959	67	16	30.4	32.6	77.32	0.000	0
3	9606260928	-0.039	31.3	1	-0.026	9277	80	18	45.0	44.8	87.45	0.000	0
4	9606261351	0.020	102.1	1	0.031	5404	63	41	25.9	24.3	43.32	0.000	0
5	9606261122	-0.010	41.4	1	0.001	3495	80	21	45.0	44.8	27.45	0.000	0

IA5100

Inconsistent rates - not temperature compensating correctly.

CSLD DIAGNOSTICS: RATE TABLE (excerpt)

T1: UNLEADED

	TIME	ST	LRT	AVTMP	TPTMP	BDTMP	TMRT	DISPNS	VOL	INTVL	DEL	ULLG	EVAP
9605270507	0	-0.140	65.9	70.0	73.7	0.00	1271	8521	31.5	24.7	322	0.000	
9605290214	0	-0.343	66.0	70.1	72.9	-0.10	1945	4983	17.0	38.9	471	0.000	
9605290334	0	-0.172	65.9	70.0	72.8	-0.09	1820	4937	44.0	40.3	473	0.000	
9605290444	0	-0.135	65.8	70.0	72.6	-0.11	1770	4911	40.5	41.4	474	0.000	
9606020430	0	0.050	70.6	72.2	76.0	-0.07	1660	7254	20.0	16.1	378	0.000	
9606020510	0	-0.301	70.5	72.2	76.1	-0.12	1591	7247	31.5	16.8	378	0.000	
9606020637	0	-0.193	70.4	72.1	75.8	-0.10	1539	7215	18.0	18.3	380	0.000	
9606030317	0	-0.408	69.2	71.8	73.1	-0.13	1584	4802	16.5	38.9	479	0.000	
9606030346	0	-0.336	69.1	71.8	73.1	-0.14	1517	4799	21.5	39.4	479	0.000	
9606030441	0	-0.249	69.0	71.7	73.1	-0.09	1474	4779	27.5	40.3	480	0.000	
9606100451	0	-0.114	68.0	71.2	72.5	-0.12	1411	4303	28.5	41.1	500	0.000	
9606110421	0	-0.136	67.8	70.6	72.8	-0.05	1956	7132	28.5	22.5	383	0.000	
9606110505	0	-0.049	67.8	70.6	72.9	-0.05	1907	7105	23.0	23.2	384	0.000	
9606120357	0	0.148	68.8	70.8	72.7	-0.05	1253	6644	17.0	4.7	403	0.000	
9606120601	0	0.133	68.7	70.6	72.2	-0.06	1247	6535	18.5	6.7	408	0.000	
9606130439	0	-0.293	73.0	73.4	75.2	-0.14	745	8532	44.0	5.8	321	0.000	
9606130608	0	0.324	72.9	73.3	74.8	-0.12	763	8464	16.0	7.3	324	0.000	
9606170258	0	-0.254	73.1	75.4	80.0	-0.12	1511	4677	21.5	38.7	484	0.000	
9606170334	0	-0.424	73.0	75.5	80.2	-0.16	1373	4672	112.0	39.3	484	0.000	
9606180420	6	-1.046	78.9	79.2	82.8	-0.26	1222	6206	49.0	10.3	421	0.000	
9606240446	0	-0.350	75.2	79.0	84.5	-0.20	1659	3399	41.0	33.0	539	0.000	

IA5100

CSLD DIAGNOSTICS: RATE TABLE (excerpt)

T2: UNLEADED PLUS

	TIME	ST	LRT	AVTMP	TPTMP	BDTMP	TMRT	DISPNS	VOL	INTVL	DEL	ULLG	EVAP
9606100818	1	-0.134	67.2	69.2	71.5	-0.04	116	10194	21.5	2.3	231	0.000	
9606110159	3	-0.081	67.4	70.1	72.3	-0.02	492	9489	69.5	19.9	273	0.000	
9606110346	3	-0.081	67.3	70.2	72.3	-0.01	460	9479	90.0	21.7	274	0.000	
9606120140	3	-0.075	67.5	70.3	71.8	-0.03	484	8763	70.0	43.6	310	0.000	
9606120329	3	-0.083	67.5	70.4	71.9	-0.02	445	8759	75.0	45.4	310	0.000	
9606120614	3	-0.044	67.4	70.5	71.8	-0.02	395	8747	57.5	48.1	311	0.000	
9606130250	0	-0.103	68.9	70.6	73.6	-0.04	245	9650	146.5	3.8	264	0.000	
9606140214	3	-0.111	68.6	71.2	75.3	-0.02	404	8974	145.5	27.1	300	0.000	
9606140515	0	-0.117	68.5	71.4	75.8	-0.02	369	8974	66.5	30.1	300	0.000	
9606150445	1	-0.051	68.5	71.6	76.7	-0.03	543	8049	27.5	53.6	343	0.000	
9606150557	3	-0.108	68.5	71.8	76.7	-0.02	506	8035	120.0	54.8	344	0.000	
9606160322	3	-0.251	70.7	73.0	78.6	-0.04	415	9276	113.5	14.8	284	0.000	
9606160601	3	-0.233	70.5	73.1	79.0	-0.04	399	9271	52.0	17.4	285	0.000	
9606170504	1	-0.142	70.2	73.4	78.9	-0.04	326	8731	29.0	40.4	312	0.000	
9606180317	3	-0.131	70.0	73.8	79.6	-0.02	395	8055	76.0	62.6	343	0.000	
9606190158	3	-0.146	69.9	73.9	78.7	-0.03	434	7315	138.5	85.3	375	0.000	
9606190524	3	-0.136	69.8	74.1	79.4	-0.03	398	7310	52.5	88.7	375	0.000	
9606191045	1	-0.062	69.7	74.1	77.5	-0.05	354	7207	28.0	94.1	380	0.000	

```

9606200101 3 -0.183 70.4 74.1 79.3 -0.07 412 7715 48.5 12.6 358 0.000
9606200241 3 -0.187 70.3 74.2 79.5 -0.05 382 7711 53.5 14.3 358 0.000
9606200429 0 -0.175 70.3 74.3 79.6 -0.04 354 7708 70.5 16.0 358 0.000
    
```

I60900

Wrong values.

JUN 26, 1996 2:39 PM

TANK	PRODUCT LABEL	
1	UNLEADED	0.000070
2	UNLEADED PLUS	0.000070
3	SUPER UNLEADED	0.000070
4	KEROSENE	0.000050
5	DIESEL	0.000045
6		0.000000
7		0.000000
8		0.000000

Analysis of Rate Table (IA5100)

The test results show that tank 2 is also close to failing. Examining the leak rates for both tanks shows negative rates. the TMRT parameter is showing a negative temperature rate. This means that the fuel is contracting during the test.

ANALYSIS OF THERMAL EXPANSION COEFFICIENT REPORT (I60900)

Checking the thermal temperature coefficient of expansion value for the tanks reveals that these values were programmed incorrectly (1 extra zero was entered for each value e.g., 0.000070 instead of 0.00070). CSLD was not able to correct for temperature change when computing the leak rate.

Solution

Correctly reprogram the coefficient of thermal expansion for each tank.

CSLD PROBLEM 6 - CSLD PERIODIC FAILURE TANK 1

Diagnostics

200

Station Header 1
 Station Header 2
 Station Header 3
 Station Header 4

Identical names suggest tanks are manifolded.

When tank levels are close tanks may be manifolded.

JUN 17, 1998 8:31 AM

TANK	PRODUCT	GALLONS	INCHES	WATER	DEG F	ULLAGE
1	<u>UNLEADED SOUTH</u>	5288	<u>48.27</u>	0.8	63.4	4528
2	<u>UNLEADED NORTH</u>	5332	<u>48.59</u>	0.0	63.8	4484
3	POWER PREMIUM	7168	62.35	0.0	66.4	2648
4	POWER PLUS	6150	54.60	0.0	65.2	3666

I25100
 JUN 17, 1998 8:32 AM

Station Header 1
 Station Header 2
 Station Header 3
 Station Header 4

Tanks programmed as manifolded would have a common result.

CSLD TEST RESULTS

TANK	PRODUCT	RESULT
1	UNLEADED SOUTH	PER: JUN 17, 1998 <u>FAIL</u>
2	UNLEADED NORTH	PER: JUN 17, 1998 <u>PASS</u>
3	POWER PREMIUM	PER: JUN 17, 1998 PASS
4	POWER PLUS	PER: JUN 17, 1998 PASS

IA5200
 JUN 17, 1998 8:32 AM

Positive tests rejected, these occurred when T1 was filing this tank.

CSLD DIAGNOSTICS: RATE TEST

TK	DATE	LRATE	INTVL	ST	AVLRTE	VOL	C1	C3	FDBK	ACPT	THPUT	DFMUL	RJT
1	9806170430	-0.492	14.7	2	-0.504	6123	26	20	0.0	0.0	7.13	0.61	0
2	9806170254	0.025	14.8	1	0.015	6238	22	19	0.0	0.0	6.89	0.67	<u>9</u>
3	9806170557	0.033	22.3	1	0.025	6289	75	19	39.4	29.8	4.01	0.14	0
4	9806170527	0.033	26.6	1	0.018	6010	44	21	4.5	4.2	6.74	0.08	1

I61200
 JUN 17, 1998 8:33 AM

TANK MANIFOLDED PARTNERS

TANK	PRODUCT LABEL	MANIFOLDED TANKS
1	UNLEADED SOUTH	<u>NONE</u>
2	UNLEADED NORTH	<u>NONE</u>
3	POWER PREMIUM	NONE
4	POWER PLUS	NONE

Tanks not programmed as manifolded.

IA5100
 JUN 17, 1998 8:32 AM

Inconsistent large leak rates. T1 is filling T2 while test is running.

CSLD DIAGNOSTICS: RATE TABLE

T 1:UNLEADED SOUTH

TIME	ST	LRT	AVTMP	TPTMP	BDTMP	TMRT	DSPNS	VOL	INTVL	DEL	ULLG	THPT
9806060245	3	-0.307	63.0	66.4	69.8	-0.08	1562	4297	57.5	31.7	419	6.7
9806060527	0	-0.452	62.9	66.3	69.5	0.12	1457	4263	16.0	34.4	420	6.4
9806070032	2	0.073	60.5	64.8	69.5	0.03	649	6411	34.5	1.1	325	7.4
9806070211	0	-0.185	60.5	65.0	69.4	0.02	601	6379	111.5	2.8	327	7.0
9806070414	0	-0.459	60.5	65.2	69.3	0.11	601	6378	24.0	4.8	327	7.0
9806080228	2	0.081	59.9	60.2	69.7	0.07	225	8870	54.5	0.7	190	6.9
9806100232	3	-0.978	60.8	64.4	69.9	0.04	1680	3968	17.5	48.7	434	7.2
9806100303	3	-1.977	60.8	64.4	69.9	-0.05	1612	3966	28.5	49.2	434	7.2
9806110337	0	-0.706	63.0	64.9	70.2	-0.03	916	6092	27.0	13.2	339	7.1

CSLD DIAGNOSTICS: RATE TABLE

T 2:UNLEADED NORTH

TIME	ST	LRT	AVTMP	TPTMP	BDTMP	TMRT	DSPNS	VOL	INTVL	DEL	ULLG	THPT
9806060147	6	-0.747	63.4	67.8	71.8	-0.02	1620	4335	47.5	30.7	417	7.0
9806060245	0	-0.008	63.4	67.7	71.7	-0.02	1555	4333	58.0	31.7	417	6.7
9806060527	0	-0.420	63.3	67.4	71.2	-0.01	1452	4299	16.5	34.4	419	6.4
9806070032	2	-0.061	60.9	66.0	71.3	0.07	647	6442	35.5	0.7	324	6.9
9806070211	0	0.109	61.0	66.1	71.2	0.04	599	6406	112.0	2.4	325	6.6
9806070414	0	0.021	61.1	66.1	71.1	-0.00	599	6403	25.0	4.4	326	6.5
9806080248	2	0.046	62.1	62.6	71.2	0.01	187	8886	35.5	0.6	188	6.4
9806080434	0	-0.303	62.1	63.1	71.2	-0.02	202	8854	29.5	2.4	191	6.3
9806090040	0	-0.323	62.0	66.1	71.4	-0.01	1470	6594	23.0	22.5	317	6.7
9806090425	0	-0.427	62.0	66.2	71.2	-0.02	1329	6571	20.5	26.2	318	6.5

IA5400
 JUN 17, 1998 8:33 AM

This tank is filling T2.

CSLD DIAGNOSTICS: MOVING AVERAGE TABLE

T 1:UNLEADED SOUTH

TIME	SMPLS	TLCVOL	HEIGHT	AVGTEMP	TOPTEMP	BDTEMP
980617081037	23	5322.01	48.612	63.50	66.17	71.45
980617081107	23	5321.05	48.605	63.51	66.18	71.45
980617081137	22	5320.19	48.599	63.51	66.19	71.45
980617081207	23	5319.40	48.593	63.51	66.19	71.45
980617081237	23	5318.47	48.587	63.51	66.18	71.45
980617081307	24	5317.38	48.579	63.52	66.18	71.45

980617081337	25	5316.16	48.570	63.51	66.19	71.45
980617081407	16	5315.18	48.562	63.51	66.19	71.45
980617081437	20	5313.85	48.552	63.50	66.19	71.45
980617081507	16	5312.97	48.546	63.50	66.19	71.45
980617081537	15	5311.84	48.538	63.50	66.18	71.44
980617081607	10	5310.87	48.531	63.50	66.17	71.44
980617081637	15	5309.86	48.523	63.51	66.15	71.44
980617081707	23	5308.98	48.517	63.51	66.15	71.44
980617081737	24	5307.90	48.509	63.51	66.15	71.44
980617081807	23	5306.60	48.500	63.51	66.16	71.44
980617081837	24	5305.09	48.489	63.51	66.17	71.44
980617081907	22	5303.46	48.477	63.51	66.19	71.44
980617081937	19	5301.98	48.466	63.51	66.19	71.44
980617082007	13	5300.33	48.454	63.51	66.19	71.44
980617082037	19	5298.60	48.441	63.50	66.19	71.43
980617082107	23	5297.30	48.431	63.50	66.20	71.44
980617082137	23	5295.99	48.422	63.51	66.21	71.44
980617082207	22	5294.84	48.414	63.51	66.20	71.44
980617082237	24	5293.70	48.406	63.52	66.19	71.44
980617082307	13	5292.71	48.399	63.53	66.19	71.44
980617082337	23	5291.84	48.392	63.53	66.19	71.44
980617082407	22	5291.12	48.387	63.53	66.19	71.44
980617082437	23	5290.39	48.381	63.52	66.18	71.44
980617082507	24	5289.71	48.376	63.53	66.18	71.44
980617082537	22	5288.92	48.370	63.52	66.20	71.44
980617082607	12	5287.66	48.361	63.52	66.19	71.44
980617082637	24	5286.69	48.354	63.52	66.19	71.44
980617082707	23	5285.51	48.346	63.52	66.19	71.44
980617082737	24	5284.08	48.335	63.52	66.19	71.43
980617082807	23	5282.60	48.324	63.52	66.19	71.43
980617082837	24	5281.25	48.314	63.51	66.20	71.43
980617082907	13	5280.05	48.305	63.51	66.20	71.43
980617082937	13	5278.94	48.297	63.51	66.20	71.43
980617083007	23	5277.81	48.289	63.50	66.21	71.43
980617083037	23	5276.85	48.282	63.51	66.21	71.43
980617083107	24	5275.94	48.275	63.51	66.21	71.43
980617083137	23	5275.23	48.270	63.52	66.21	71.43
980617083207	21	5274.56	48.266	63.54	66.20	71.43
980617083237	15	5273.92	48.262	63.55	66.20	71.43
980617083307	23	5273.35	48.258	63.55	66.20	71.43

MOVING AVERAGE: 5284.02

DISPENSE STATE: ACTIVE * 762.432312

T 2:UNLEADED NORTH

	TIME	SMPLS	TLCVOL	HEIGHT	AVGTEMP	TOPTEMP	BDTEMP
980617081037	24	5358.36	48.889	63.88	67.13	72.66	
980617081107	23	5359.32	48.896	63.89	67.15	72.66	
980617081137	22	5360.10	48.901	63.88	67.15	72.66	
980617081207	23	5357.81	48.885	63.88	67.15	72.67	
980617081237	23	5353.93	48.856	63.87	67.16	72.67	
980617081307	24	5350.46	48.830	63.87	67.17	72.67	
980617081337	23	5349.34	48.822	63.87	67.17	72.67	
980617081407	16	5347.34	48.808	63.87	67.15	72.67	
980617081437	20	5348.24	48.814	63.88	67.15	72.67	

T2's volume increases as T1 fills it.

980617081507	16	5349.11	48.821	63.89	67.15	72.67
980617081537	15	5348.68	48.818	63.88	67.14	72.67
980617081607	10	5347.10	48.806	63.88	67.13	72.67
980617081637	15	5347.82	48.811	63.88	67.12	72.67
980617081707	23	5345.59	48.795	63.87	67.13	72.67
980617081737	24	5340.45	48.757	63.86	67.14	72.67
980617081807	23	5332.53	48.699	63.85	67.14	72.67
980617081837	23	5327.48	48.662	63.85	67.13	72.67
980617081907	22	5323.96	48.636	63.85	67.13	72.67
980617081937	18	5321.93	48.621	63.85	67.13	72.67
980617082007	14	5323.43	48.632	63.85	67.12	72.67
980617082037	19	5325.39	48.647	63.86	67.13	72.66
980617082107	23	5326.68	48.656	63.86	67.14	72.66
980617082137	22	5327.94	48.666	63.87	67.14	72.67
980617082207	23	5329.04	48.674	63.87	67.14	72.67
980617082237	24	5330.24	48.682	63.86	67.14	72.68
980617082307	12	5331.09	48.688	63.86	67.13	72.68
980617082337	24	5332.11	48.696	63.86	67.12	72.68
980617082407	22	5332.77	48.701	63.86	67.12	72.68
980617082507	23	5329.52	48.677	63.85	67.15	72.68
980617082537	22	5324.32	48.639	63.85	67.16	72.68
980617082607	12	5321.19	48.616	63.86	67.16	72.68
980617082637	24	5319.28	48.602	63.87	67.16	72.68
980617082707	23	5315.00	48.571	63.86	67.16	72.68
980617082737	24	5309.65	48.531	63.86	67.15	72.68
980617082807	23	5309.97	48.534	63.87	67.15	72.68
980617082837	23	5311.16	48.543	63.87	67.14	72.69
980617082907	13	5311.96	48.549	63.87	67.14	72.69
980617082937	12	5313.25	48.558	63.87	67.14	72.68
980617083007	24	5314.42	48.567	63.87	67.13	72.68
980617083037	23	5315.37	48.574	63.87	67.14	72.68
980617083107	24	5316.16	48.579	63.87	67.14	72.69
980617083137	22	5316.99	48.585	63.86	67.14	72.69
980617083207	21	5317.58	48.590	63.86	67.14	72.69
980617083237	15	5316.19	48.580	63.87	67.14	72.69
980617083307	23	5312.81	48.555	63.86	67.13	72.69
980617083337	20	5311.06	48.542	63.86	67.13	72.69

MOVING AVERAGE: 5311.55

DISPENSE STATE: ACTIVE 957.217224

Analysis

Tanks 1 and 2 are siphon manifolded, but they are incorrectly programmed in the console as single tanks.

Solution

Reprogram tanks 1 and 2 as manifolded and delete the rate table.

CSLD PROBLEM 7 - NO CSLD RESULTS

Diagnostics

I20100
MAY 14, 1998 11:44 AM

Station id 1
Station id 2
Station id 3
Station id 4

IN-TANK INVENTORY

TANK	PRODUCT	VOLUME	TLC	VOLUME	ULLAGE	HEIGHT	WATER	TEMP
1	REGULAR UNLEADED	6912		0	3115	62.50	0.00	73.39
2	PLUS UNLEADED	1845		0	8182	22.99	0.00	74.96
3	PREMIUM UNLEADED	3761		0	6266	38.52	0.00	73.95

IA5200
MAY 14, 1998 11:45 AM

No tests.

CSLD DIAGNOSTICS: RATE TEST

TK	DATE	LRATE	INTVL	ST	AVLRTE	VOL	C1	C3	FDBK	ACPT	THPUT	DFMUL	RJT
1	7001010000	0.000	0.0	5	0.000	0	0	0	0.0	0.0	0.00	0.80	0
2	7001010000	0.000	0.0	5	0.000	0	0	0	0.0	0.0	0.00	0.80	0
3	7001010000	0.000	0.0	5	0.000	0	0	0	0.0	0.0	0.00	0.80	0

IA5300
MAY 14, 1998 11:45 AM

CSLD DIAGNOSTICS: VOLUME TABLE

T 1:REGULAR UNLEADED

LAST HOUR = 248651

6876.8	6949.6	6985.7	7110.7	7191.0	7282.3	7354.8	0.0
0.0	0.0	0.0	0.0	0.0	0.0	0.0	0.0
0.0	0.0	0.0	0.0	0.0	0.0	0.0	0.0

Table not full.

T 2:PLUS UNLEADED

LAST HOUR = 248651

1825.8	1846.9	1868.8	1900.3	1936.7	1936.7	1947.3	0.0
0.0	0.0	0.0	0.0	0.0	0.0	0.0	0.0
0.0	0.0	0.0	0.0	0.0	0.0	0.0	0.0

T 3:PREMIUM UNLEADED

LAST HOUR = 248651

3737.9	3773.5	3797.8	3817.8	3883.3	3904.5	3904.7	0.0
0.0	0.0	0.0	0.0	0.0	0.0	0.0	0.0
0.0	0.0	0.0	0.0	0.0	0.0	0.0	0.0

Analysis

The volume table IA53 gets cleared when a gap in time between probe samples is detected. The site operators were turning the console's power Off every evening. This caused a gap between probe readings which cleared the volume table. CSLD does not perform any tests until the volume table is full (24 hours).

Solution

Keep power turned On to the console.

CSLD PROBLEM 8 - CSLD FAILURE TANK 1

Diagnostics

I25100

JUN 11, 1998 12:45 PM

Site Id 1
 Site Id 2
 Site Id 3
 Site Id 4

CSLD TEST RESULTS

TANK	PRODUCT	RESULT
1	REGULAR	PER: JUN 11, 1998 FAIL
2	PLUS	PER: JUN 11, 1998 PASS
3	PREMIUM	PER: JUN 11, 1998 PASS

200

Site Id 1
 Site Id 2
 Site Id 3
 Site Id 4

JUN 11, 1998 12:45 PM

TANK	PRODUCT	GALLONS	INCHES	WATER	DEG F	ULLAGE
1	REGULAR	6439	57.38	1.0	52.3	3289

2	PLUS	6362	56.81	0.0	68.1	3366
3	PREMIUM	7916	69.05	0.0	67.3	1812

IA5200
JUN 11, 1998 12:45 PM

CSLD DIAGNOSTICS: RATE TEST

Comparing compensated LRATE to uncompensated AVLRATE shows excessive compensation.

TK	DATE	LRATE	INTVL	ST	AVLRATE	VOL	C1	C3	FDBK	ACPT	THPUT	DFMUL	RJT
1	9806110308	<u>-0.309</u>	13.0	2	<u>0.040</u>	6676	56	22	18.0	12.3	8.22	0.40	0
2	9806110404	-0.011	25.0	1	0.025	7865	80	16	45.0	44.0	2.28	0.02	0
3	9806110021	-0.011	26.6	1	0.012	7087	80	16	45.0	44.2	2.01	-0.00	0

I60900
JUN 11, 1998 12:46 PM

TANK THERMAL COEFFICIENT

OK

TANK	PRODUCT LABEL	
1	REGULAR	0.000700
2	PLUS	0.000700
3	PREMIUM	0.000700
4		0.000000

IA5101
JUN 11, 1998 12:46 PM

Abnormal temperatures.

Large jump in temp following delivery.

CSLD DIAGNOSTICS: RATE TABLE

T 1:REGULAR

	TIME	ST	LRT	AVTMP	TEMP	BDTMP	TMRT	DSPNS	VOL	INTVL	DEL	ULLG	THPT
9805230026	3	0.050	69.2	14.7	71.3	-0.02	2052	2976	24.5	34.7	452	8.2	
9805230102	3	0.011	69.2	14.7	71.3	-0.03	1991	2972	30.0	35.3	452	8.0	
9805230148	3	0.016	69.1	14.7	71.2	-0.02	1915	2964	38.5	36.0	452	7.9	
9805230239	3	0.006	69.1	14.7	71.2	-0.02	1841	2953	69.5	36.9	453	7.6	
9805230441	3	0.021	69.0	14.7	71.2	-0.02	1729	2910	29.5	38.9	455	7.4	
9805230557	3	0.017	<u>69.0</u>	14.7	71.2	-0.00	1687	2856	29.5	40.2	457	7.3	
9805240018	0	-0.018	<u>55.4</u>	14.7	72.0	-0.03	561	7499	33.5	4.6	255	8.1	
9805240144	0	-0.041	55.3	14.7	72.0	-0.03	565	7470	23.5	6.0	256	7.9	
9805240224	1	-0.069	55.2	14.7	71.9	-0.04	565	7454	19.0	6.6	257	7.9	

9805240303	0	0.057	55.1	14.7	71.9	-0.05	584	7426	45.0	7.3	259	7.8
9805240454	0	-0.138	54.9	14.7	71.8	-0.00	594	7366	21.5	9.1	262	7.7
9805240552	0	-0.084	54.8	14.7	71.8	-0.01	593	7337	40.0	10.1	263	7.5
9805250213	3	-0.048	51.2	14.7	72.0	-0.03	1599	5019	32.5	30.5	366	7.8
9805250340	0	-0.026	51.3	14.7	71.9	-0.04	1481	4988	24.0	31.9	367	7.8
9805250526	1	0.178	<u>51.8</u>	14.7	71.7	-0.08	1468	4911	18.0	33.7	370	7.7
9805250617	0	0.343	<u>70.5</u>	14.7	71.5	-0.13	1424	4821	26.0	34.5	371	7.7
9805250655	1	0.296	70.4	14.7	71.4	-0.12	1446	4812	18.5	35.2	372	7.6
9805260040	1	0.183	55.6	14.7	71.8	-0.08	650	7598	17.5	5.2	250	7.9
9805260118	1	0.124	55.5	14.7	71.7	-0.07	629	7580	16.5	5.8	251	7.9
9805260227	6	0.242	55.3	14.7	71.6	-0.08	604	7540	98.5	7.0	253	7.7
9805260417	0	0.277	55.1	14.7	71.5	-0.07	604	7540	98.5	7.0	253	7.7
9805270015	0	0.051	46.7	14.7	71.5	-0.07	604	7540	98.5	7.0	253	7.7
9805270109	0	0.053	46.7	14.7	71.1	-0.05	1174	5704	65.0	29.7	338	7.5
9805270303	0	0.019	46.8	14.7	70.9	-0.05	1164	5656	34.0	31.6	340	7.5
9806020056	2	-0.004	55.7	14.7	70.5	-0.00	375	8102	28.0	1.4	222	7.9
9806020136	0	0.045	55.7	14.7	70.6	-0.00	370	8090	46.0	2.1	223	7.9
9806020234	0	0.050	55.6	14.7	70.5	-0.01	359	8086	63.5	3.1	223	7.9
9806020442	0	0.022	55.6	14.7	70.5	-0.00	351	8061	43.0	5.2	225	7.8
9806030030	3	0.026	46.5	14.7	71.0	-0.01	1487	5697	108.5	25.0	338	7.9
9806030231	1	0.028	46.6	14.7	71.0	-0.02	1487	5688	18.5	27.0	339	7.9
9806030308	0	0.014	<u>46.7</u>	14.7	70.9	-0.02	1454	5660	44.5	27.6	340	7.9
9806040208	3	0.039	<u>67.7</u>	14.7	70.3	-0.05	2093	2291	23.5	50.7	485	8.1
9806040317	3	0.016	67.7	14.7	70.1	-0.05	2012	2267	37.5	51.8	486	8.1
9806040426	3	0.014	67.7	14.7	70.0	-0.04	1856	2245	61.5	52.9	487	8.0
9806050031	0	-0.008	42.0	14.7	70.9	-0.05	1002	6740	34.5	9.5	294	8.2
9806050118	0	0.015	42.1	14.7	70.8	-0.05	1002	6726	24.0	10.3	295	8.2
9806050154	0	0.007	42.1	14.7	70.8	-0.04	983	6719	21.0	10.9	295	8.1

Big swing in temperature even though there has been no delivery.

Template for A12 command

```
IA1200
JUN 11, 1998 12:47 PM
TANK 1 REGULAR MAG NUMBER OF SAMPLES = 20
WATER HEIGHT0 HEIGHT1 HEIGHT2 HEIGHT3 HEIGHT4 HEIGHT5 HEIGHT6
HEIGHT7 HEIGHT8 HEIGHT9 TMP REF TMP5 TMP4 TMP3 TMP2
TMP1 TMP0 TMP REF
```

Probe Standard Average Buffers

```
IA1200
JUN 11, 1998 12:47 PM
TANK 1 REGULAR MAG NUMBER OF SAMPLES = 20
1477.000 19845.199 19845.150 19844.699 19845.350 19847.150 19847.199 19847.301
19847.051 19847.400 19847.350 42377.398 17287.949 42375.449 17287.301 42375.898
17286.199 19271.199 42375.051
TANK 2 PLUS MAG NUMBER OF SAMPLES = 20
1371.150 19443.000 19443.000 19443.000 19443.000 19442.850 19443.000 19443.000
19443.000 19442.949 19443.000 42508.199 17503.051 18755.250 19174.350 19427.551
19583.150 20000.600 42506.000
TANK 3 PREMIUM MAG NUMBER OF SAMPLES = 20
```

Bad probe thermistor values.

```

1383.000 23473.699 23473.500 23473.699 23473.699 23473.500 23485.051 23484.699
23484.850 23485.150 23484.949 41917.949 17255.750 18685.750 19646.900 19714.150
19804.750 19917.900 41901.301
    
```

Analysis

From the IA52 command compare LRATE (-0.309) with AVLRTE (0.040). This shows that there is excessive compensation. The most likely cause for excessive compensation is a false probe temperature reading. Examining the IA12 command shows that there are two erroneous thermistor values.

Solution

Replace probe and delete rate table.

CSLD PROBLEM 9 - TANK 1 FAIL

Diagnostics

```

200
Site ID
Site ID
Site ID
Site ID
    
```

MAY 18, 2000 8:23

TANK	PRODUCT	GALLONS	INCHES	WATER	DEG F	ULLAGE
1	UNLEADED	4740	44.69	0.0	61.2	4896
2	PLUS	5740	63.65	0.0	61.9	1952
3	PREMIUM	2712	62.65	0.0	62.0	1010

CSLD TEST RESULTS

TANK	PRODUCT	RESULT
1	UNLEADED	PER: MAY 18, 2000 FAIL
2	PLUS	PER: MAY 18, 2000 PASS
3	PREMIUM	PER: MAY 18, 2000 PASS

```

___ 76687IA5200_
IA5200
MAY 18, 2000 8:23
    
```

Comparing compensated LRATE to uncompensated AVLRTE shows excessive compensation.

CSLD DIAGNOSTICS: RATE TEST

TK	DATE	LRATE	INTVL	ST	AVLRTE	VOL	C1	C3	FDBK	ACPT	THPUT	EVAP	RJT
1	0005180427	<u>-0.282</u>	37.0	2	<u>0.017</u>	6709	70	17	33.8	33.8	127.1	0.000	0
2	0005180735	-0.025	32.5	1	0.026	5558	80	19	45.0	44.8	17.6	0.000	0
3	0005180531	-0.061	32.3	1	-0.000	2589	80	17	45.0	44.8	8.6	0.000	0

IA5101
MAY 18, 2000 8:25

CSLD DIAGNOSTICS: RATE TABLE
T 1:UNLEADED

	TIME	ST	LRT	AVTMP	TPTMP	BDTMP	TMRT	DSPNS	VOL	INTVL	DEL	ULLG	EVAP
0004200431	0	-0.085	53.3	52.0	56.5	0.00	2	9682	50.0	48.5	0	0.000	
0004202332	3	0.068	55.2	55.5	57.2	-0.03	3073	4904	129.5	14.8	372	0.000	
0004210148	3	-0.044	55.1	55.4	57.2	-0.03	2712	4904	174.5	17.8	372	0.000	
0004210448	3	-0.174	55.0	55.4	57.1	-0.02	2601	4904	54.0	20.8	372	0.000	
0004222339	0	-0.023	52.3	54.1	55.8	0.02	1585	6548	129.5	8.7	301	0.000	
0004230155	0	0.012	52.4	53.5	55.6	0.01	1398	6548	174.5	11.7	301	0.000	
0004230456	0	0.027	52.4	52.6	55.4	0.01	1234	6548	168.5	14.8	301	0.000	
0004232246	3	0.038	53.2	53.0	55.8	-0.00	2597	2936	129.5	31.8	459	0.000	
0004240105	3	0.005	53.2	53.1	55.8	-0.00	2292	2936	171.0	34.8	459	0.000	
0004240407	3	-0.011	53.2	53.2	55.7	0.00	2109	2936	57.0	37.9	459	0.000	
0004242334	0	0.052	56.6	56.0	56.5	-0.06	1649	5721	129.5	6.6	337	0.000	
0004250156	0	-0.002	56.4	56.0	56.4	-0.05	1455	5721	168.0	9.6	337	0.000	
0004250458	1	-0.047	56.3	56.0	56.2	-0.04	1395	5721	18.5	12.6	337	0.000	
0004252306	2	-0.024	55.8	55.9	56.8	-0.02	382	8435	129.5	1.0	199	0.000	
0004260131	0	-0.016	55.8	55.9	56.8	-0.01	337	8435	165.5	4.0	199	0.000	
0004260432	0	0.050	55.7	55.8	56.8	-0.01	323	8435	50.5	7.0	199	0.000	
0004262332	3	-0.036	55.8	56.0	57.5	-0.03	2846	4236	129.5	25.4	401	0.000	
0004270158	3	0.024	55.8	55.9	57.5	-0.02	2511	4236	164.0	28.4	401	0.000	
0004270459	1	-0.414	55.7	55.9	57.5	-0.02	2409	4236	27.0	31.5	401	0.000	
0004272326	3	0.036	58.4	57.6	58.5	-0.08	2029	4975	129.5	6.3	369	0.000	
0004280154	3	-0.039	58.2	57.6	58.4	-0.06	1790	4975	162.5	9.3	369	0.000	
0004282311	0	0.061	59.1	57.1	59.4	-0.06	1659	6434	129.5	6.4	305	0.000	
0004290140	0	-0.002	58.9	57.1	59.4	-0.06	1464	6434	161.0	9.4	305	0.000	
0004290441	0	0.021	58.8	57.0	59.4	-0.05	1345	6434	98.0	12.4	305	0.000	
0004292345	3	0.074	58.3	56.0	60.1	-0.10	3384	1251	129.5	31.0	551	0.000	
0004300216	3	0.028	58.0	58.0	60.1	-0.09	2986	1251	159.0	34.0	551	0.000	
0004300518	3	0.007	57.8	57.9	60.1	-0.07	2618	1251	110.5	37.0	551	0.000	
0004302242	3	0.050	56.8	57.5	61.1	-0.02	2587	3949	129.5	12.9	413	0.000	
0005010116	3	-0.022	56.7	57.9	61.1	-0.02	2283	3950	156.5	15.9	413	0.000	
0005010417	3	-0.099	56.7	57.8	61.1	-0.02	2190	3950	39.0	18.9	413	0.000	
0005012322	3	0.000	58.1	58.9	61.7	-0.03	2100	5699	129.5	12.1	338	0.000	
0005020159	3	0.027	58.0	58.8	61.7	-0.03	1853	5699	153.5	15.1	338	0.000	
0005022346	3	0.047	58.0	58.8	62.1	-0.08	2882	1445	129.5	36.5	539	0.000	
0005030225	3	-0.014	57.8	58.9	62.0	-0.06	2652	1445	49.0	39.5	539	0.000	
0005032325	3	0.061	57.2	57.9	62.8	-0.03	2922	4110	129.5	19.0	406	0.000	
0005040206	3	0.034	57.2	58.3	62.9	-0.02	2578	4110	149.5	22.0	406	0.000	
0005042339	3	0.032	63.4	<u>-107.4</u>	64.6	-0.10	1791	6496	147.5	7.8	301	0.000	
0005050222	3	0.007	63.1	<u>-105.1</u>	64.7	-0.10	1791	6496	147.5	10.8	301	0.000	
0005052345	3	0.053	61.8	61.2	65.9	-0.14	3175	1823	129.5	31.8	516	0.000	
0005060230	3	0.007	61.4	60.5	65.9	-0.12	2801	1823	145.5	34.8	516	0.000	
0005060531	3	-0.025	61.1	60.2	65.9	-0.11	2571	1823	51.5	37.9	516	0.000	
0005062349	3	0.006	61.1	51.2	67.2	-0.06	3140	3581	129.5	14.1	429	0.000	
0005070236	3	0.012	60.9	51.4	67.2	-0.06	2771	3581	143.5	17.1	429	0.000	
0005070537	3	-0.040	60.7	51.0	67.3	-0.04	2547	3581	124.0	20.1	429	0.000	
0005072237	0	-0.023	66.8	<u>-107.5</u>	68.8	-0.16	792	7014	129.5	2.5	275	0.000	

Intermittent bad values.

0005080126	0	0.020	66.4	<u>-107.4</u>	69.0	-0.13	699	7014	141.5	5.5	276	0.000
0005080427	1	0.129	66.0	<u>-107.3</u>	69.1	-0.11	670	7014	30.5	8.5	276	0.000
0005082328	3	0.097	64.5	<u>-107.3</u>	70.3	-0.16	2854	2747	129.5	27.3	467	0.000
0005090218	3	0.051	64.1	<u>-107.3</u>	70.3	-0.14	2518	2747	140.5	30.3	467	0.000
0005092322	3	0.003	64.6	<u>-83.9</u>	71.2	-0.07	1982	5745	129.5	9.1	334	0.000
0005100213	0	0.036	64.4	41.9	71.2	-0.06	1749	5744	139.5	12.1	334	0.000
0005102331	3	0.039	63.7	30.1	71.2	-0.13	2855	1559	129.5	33.3	531	0.000
0005110222	3	0.036	63.4	35.6	71.0	-0.10	2520	1559	139.0	36.3	531	0.000
0005112319	3	0.048	62.5	<u>-107.1</u>	70.7	-0.04	2878	4154	129.5	15.0	404	0.000
0005120210	3	0.009	62.3	<u>-72.8</u>	70.7	-0.04	2540	4154	139.0	18.0	404	0.000
0005130136	2	0.030	69.8	<u>-107.2</u>	71.1	-0.24	824	6333	138.5	0.2	307	0.000
0005130437	0	0.077	69.1	<u>-107.3</u>	71.3	-0.17	723	6333	114.5	3.2	307	0.000
0005132347	3	0.028	67.1	<u>-107.0</u>	71.6	-0.22	3350	1342	129.5	22.2	545	0.000
0005140237	3	0.008	66.5	<u>-107.2</u>	71.4	-0.17	2956	1342	140.5	25.2	545	0.000
0005140537	3	0.038	66.0	<u>-106.0</u>	71.2	-0.16	2788	1342	140.5	28.3	545	0.000
0005142248	3	-0.013	60.1	<u>-79.5</u>	70.7	0.00	2724	3396	140.5	14.9	438	0.000
0005150138	3	0.007	60.1	<u>-72.9</u>	70.6	-0.00	2724	3396	140.5	17.9	438	0.000
0005150438	3	-0.051	60.1	<u>-72.7</u>	70.4	-0.00	2507	3396	45.0	20.9	438	0.000
0005152328	0	0.054	64.5	<u>-94.8</u>	70.4	-0.07	1260	5499	129.5	5.7	345	0.000
0005160218	0	0.013	64.3	<u>-107.2</u>	70.3	-0.06	1112	5499	140.5	8.7	345	0.000
0005162319	3	0.052	64.1	<u>-106.1</u>	69.7	-0.14	2548	1734	129.5	29.5	521	0.000
0005170209	3	0.020	63.7	<u>-98.6</u>	69.6	-0.12	2444	1734	32.0	32.5	521	0.000
0005170352	2	0.007	60.2	60.5	69.1	0.08	615	9215	68.0	0.2	131	0.000
0005172312	3	0.034	61.5	<u>35.6</u>	68.9	-0.02	2757	5141	129.5	19.3	361	0.000
0005180202	3	-0.010	61.5	<u>-91.1</u>	68.8	-0.02	2433	5141	140.5	22.3	361	0.000

Intermittent bad values.

Yet probe's temperature readings look good at this time!

```

__I_I_ 76687IA1000_
IA1000
MAY 18, 2000 8:27
TANK 1 UNLEADED          MAG      NUMBER OF SAMPLES = 9445
 1334.000 15481.000 15480.000 15480.000 15480.000 15482.000 15483.000 15485.000
15489.000 15494.000 15497.000 45689.000 20931.000 23464.000 23409.000 23962.000
24250.000 24810.000 45691.000
TANK 2 PLUS              MAG      NUMBER OF SAMPLES = 523
 1309.000 22143.000 22143.000 22143.000 22143.000 22143.000 22145.000 22144.000
22145.000 22145.000 22146.000 45504.000 21342.000 22545.000 23465.000 24019.000
24086.000 24730.000 45503.000
TANK 3 PREMIUM          MAG      NUMBER OF SAMPLES = 462
 1312.000 21871.000 21871.000 21871.000 21871.000 21871.000 21871.000 21871.000
21872.000 21871.000 21871.000 44889.000 21445.000 22442.000 22975.000 23510.000
23695.000 24592.000 44892.000

```

Analysis

From the IA52 command compare LRATE (-0.282) with AVL RTE (0.017). This shows that there is excessive compensation. The most likely cause for excessive compensation is a false probe temperature reading. Examining the IA52 command did not show erroneous thermistor values. However, examining the IA51 command showed that the board temperature value was intermittently bad.

Solution

Replace probe and delete rate table.

CSLD PROBLEM 10 - TANK 8 FAILING

Diagnostics

I61200
MAY 7, 1999 10:10 AM

TANK MANIFOLDED PARTNERS

TANK	PRODUCT LABEL	MANIFOLDED TANKS
1	DIESEL 1	2, 3, 4, 5
2	DIESEL 2	1, 3, 4, 5
3	DIESEL 3	1, 2, 4, 5
4	DIESEL 4	1, 2, 3, 5
5	DIESEL 5	1, 2, 3, 4
6	AUTO DIESEL	NONE
7	SUPER	NONE
8	REGULAR 1	9
9	REGULAR 2	8
10		NONE
11		NONE
12		NONE

Manifolded set.

IA5200
MAY 7, 1999 10:11 AM

CSLD DIAGNOSTICS: RATE TEST

TK	DATE	LRATE	INTVL	ST	AVLRTE	VOL	C1	C3	FDBK	ACPT	THPUT	DFMUL	RJT
6	9905070326	-0.013	41.1	1	0.000	7740	80	22	45.0	44.8	0.86	-0.36	0
7	9905070456	0.003	22.2	1	0.014	4823	58	23	20.3	16.9	0.87	0.18	1
8	9905070428	0.246	6.8	8	0.241	8708	11	10	0.0	0.0	2.86	0.79	<u>12</u>

Positive rejects.

IA5100
MAY 7, 1999 10:11 AM
T 8:REGULAR 1

Positives

	TIME	ST	LRT	AVTMP	TPTMP	BDTMP	TMRT	DSPNS	VOL	INTVL	DEL	ULLG	THPT
9904120309	0	0.395	64.3	67.8	71.5	-0.02	980	8808	36.0	36.8	909	3.0	
9904130447	0	0.213	64.8	68.5	72.3	-0.01	849	5892	23.0	62.7	1038	3.0	
9904280337	0	0.226	67.1	68.9	70.0	-0.02	608	6015	63.5	75.2	1028	3.1	
9904280451	0	0.244	67.1	68.9	70.1	-0.03	578	6013	36.5	76.4	1028	3.1	
9904300319	0	0.198	64.8	68.5	72.3	0.05	1102	10406	26.5	15.5	835	3.1	
9905030233	0	0.130	65.9	69.9	74.2	0.01	1124	12183	22.0	17.1	762	3.1	
9905030302	6	-0.032	65.9	69.9	74.2	0.01	983	12183	117.5	17.8	762	3.1	
9905040303	0	0.324	66.8	70.7	74.7	-0.00	902	9501	29.5	41.7	877	2.8	
9905040453	0	0.178	66.8	70.6	74.6	-0.01	856	9453	46.5	43.3	879	2.8	
9905050339	0	0.186	67.4	71.0	74.8	-0.00	697	11738	90.0	10.	785	2.8	
9905070428	0	0.370	68.2	71.8	75.1	-0.02	719	7068	37.0	59.0	983	2.9	

```

I61101
MAY 7, 1999 10:13 AM
      LEAK          TEST  <-----START TEST TIME----->
      TEST   TEST   TEST   START
TANK  METHOD  TYPE   HOURS  METHOD  YEAR  MONTH  DAY  OCCUR  HH:MM
-----
8     CSLD   PER.   AUTO   CSLD
9     NONE
    
```

Analysis

Tanks 8 and 9 were manifolded and programmed as manifolded. However, the leak test frequency selected for Tank 9 was not CSLD. The CSLD program was only using Tank 8's volume to perform the test. When Tank 9 was filling, Tank 8's LRATE was positive.

Solution

Set Tank 9's Leak Test Method to CSLD and delete tank 8 and 9 rate tables.

CSLD PROBLEM 11 - PERIODIC TEST FAIL TANK 2

Diagnostics

```

200
Site ID
Site ID
Site ID
NOV 16, 1999 1:06 PM
    
```

TANK	PRODUCT	GALLONS	INCHES	WATER	DEG F	ULLAGE
1	REGULAR	8543	61.99	0.0	77.4	3139
2	PLUS	3705	32.53	0.0	85.2	7977
3	SUPREME	6024	46.50	0.0	80.4	5658

```

___ 76687IA5100_
IA5100
NOV 16, 1999 1:06 PM
    
```

CSLD DIAGNOSTICS: RATE TABLE
T 2:PLUS

High 90s inconsistent with other tanks.

	TIME	ST	LRT	AVTMP	TPTMP	BDTMP	TMRT	DSPNS	VOL	INTVL	DEL	ULLG	THPT
9910181409	3	-1.252	<u>98.7</u>	<u>97.2</u>	<u>98.9</u>	0.36	734	601	50.0	26.5	717	2.4	
9910181537	6	-0.824	<u>99.2</u>	<u>97.2</u>	<u>98.9</u>	0.39	582	599	142.0	28.0	717	2.4	
9910190355	1	-0.464	<u>91.4</u>	<u>96.5</u>	<u>98.9</u>	0.28	432	2783	14.0	9.1	572	2.4	
9910192324	3	-0.132	<u>96.6</u>	<u>96.9</u>	<u>98.9</u>	-0.21	898	1474	52.5	28.6	646	2.4	
9910200241	3	-0.152	<u>96.0</u>	<u>96.6</u>	<u>98.9</u>	-0.13	753	1445	143.5	31.9	648	2.4	

CSLD DIAGNOSTICS: RATE TABLE

T 3: SUPREME

	TIME	ST	LRT	AVTMP	TPTMP	BDTMP	TMRT	DSPNS	VOL	INTVL	DEL	ULLG	THPT
9910190459	0	-0.166		<u>85.9</u>	<u>88.1</u>	<u>88.8</u>	0.02	1074	5434	52.5	10.2	456	6.9
9910200011	0	-0.131		<u>85.7</u>	<u>88.0</u>	<u>88.9</u>	0.03	925	5970	34.5	4.3	434	6.9
9910200121	0	-0.134		<u>85.8</u>	<u>88.0</u>	<u>88.9</u>	0.03	862	5958	47.0	5.4	434	6.9
9910200243	0	-0.102		<u>85.8</u>	<u>88.1</u>	<u>88.9</u>	0.03	797	5955	126.0	6.8	434	6.9

CSLD DIAGNOSTICS: RATE TABLE

T 1: REGULAR

	TIME	ST	LRT	AVTMP	TPTMP	BDTMP	TMRT	DSPNS	VOL	INTVL	DEL	ULLG	THPT
9910200045	0	-0.049		<u>84.9</u>	<u>86.2</u>	<u>88.6</u>	0.04	856	8970	47.0	4.6	301	10.7
9910200212	0	-0.022		<u>85.0</u>	<u>86.3</u>	<u>88.6</u>	0.02	755	8969	109.5	6.1	301	10.7
9910200451	0	0.115		<u>85.1</u>	<u>86.5</u>	<u>88.6</u>	0.00	753	8940	26.0	8.7	302	10.7
9910210348	3	-0.096		<u>86.3</u>	<u>87.0</u>	<u>88.7</u>	0.02	1455	8414	31.0	12.2	327	10.7
9910210459	0	-0.011		<u>86.3</u>	<u>87.0</u>	<u>88.7</u>	0.02	1394	8410	32.5	13.4	328	10.7
9910220344	0	-0.087		<u>84.4</u>	<u>85.7</u>	<u>88.5</u>	0.05	661	9773	43.5	6.4	257	10.7

Mid 80s

Analysis

It can be seen that the temperatures in Tank 2 are abnormally higher than in the other tanks. This problem was traced to a stuck relay. The pump was running continuously and heating up the fuel.

Solution

Replace the stuck relay for pump in Tank 2.

CSLD PROBLEM 12 - PERIODIC TEST FAIL ON TANK 1

Diagnostics

IA5400

NOV 20, 1998 7:31 AM

CSLD DIAGNOSTICS: MOVING AVERAGE TABLE

T 1: PREM

	TIME	SMPLS	TLCVOL	HEIGHT	AVGTEMP	TOPTMP	BDTEMP
981120072142		30	3456.82	36.518	61.85	60.91	57.32
981120072212		31	3456.80	36.518	61.85	60.90	57.32
981120072242		30	3456.80	36.518	61.85	60.90	57.33
981120072312		30	3456.76	36.518	61.85	60.90	57.33
981120072342		30	3456.78	36.518	61.85	60.90	57.34
981120072412		31	3456.79	36.518	61.85	60.90	57.34
981120072442		30	3456.80	36.518	61.85	60.90	57.34
981120072512		30	3455.51	36.408	61.85	60.90	57.34
981120072542		31	3451.16	36.408	61.85	60.90	57.35
981120072612		30	3446.74	36.408	61.85	60.90	57.35
981120072642		31	3441.81	36.408	61.85	60.90	57.35
981120072712		30	3437.17	36.408	61.85	60.90	57.35
981120072742		30	3435.84	36.408	61.85	60.90	57.34
981120072812		31	3435.37	36.408	61.85	60.90	57.34
981120072842		30	3435.12	36.408	61.85	60.89	57.34

Dispensing

Slow decrease in vol.

981120072912	31	3434.87	36.405	61.85	60.89	57.33
981120072942	30	3434.70	36.404	61.85	60.89	57.33
981120073012	30	3434.65	36.404	61.85	60.89	57.32
981120073042	31	3434.54	36.403	61.85	60.88	57.32
981120073112	30	3434.45	36.403	61.85	60.88	57.32
981120073142	31	3434.39	36.403	61.85	60.87	57.31
981120073212	29	3434.29	36.402	61.85	60.87	57.31
981120073242	30	3434.18	36.402	61.85	60.86	57.30
981120073312	30	3434.04	36.401	61.85	60.86	57.30
981120073342	30	3433.96	36.400	61.85	60.85	57.30
981120073412	31	3433.91	36.400	61.85	60.85	57.30
981120073442	30	3433.88	36.400	61.85	60.85	57.30
981120073512	31	3433.84	36.400	61.85	60.84	57.30
981120073542	30	3433.85	36.400	61.85	60.84	57.31
981120073642	31	3433.81	36.400	61.85	60.83	57.31
981120073712	30	3433.82	36.400	61.85	60.83	57.32
981120073742	31	3433.77	36.399	61.85	60.83	57.32
981120073812	30	3433.69	36.399	61.85	60.83	57.32
981120073842	31	3433.63	36.399	61.85	60.82	57.33
981120073912	30	3433.62	36.399	61.85	60.82	57.33
981120073942	31	3433.56	36.398	61.85	60.83	57.33
981120074012	30	3433.63	36.399	61.85	60.83	57.33
981120074042	30	3433.58	36.398	61.85	60.83	57.33
981120074112	30	3433.60	36.399	61.85	60.83	57.33
981120074142	30	3433.60	36.399	61.85	60.84	57.33
981120074212	31	3433.57	36.398	61.85	60.84	57.33
981120074242	30	3433.55	36.398	61.85	60.84	57.33
981120074312	31	3433.54	36.398	61.85	60.85	57.33
981120074342	30	3433.50	36.398	61.85	60.85	57.34
981120074412	31	3433.43	36.398	61.85	60.85	57.34
981120074442	30	3433.48	36.398	61.85	60.86	57.34
981120074512	31	3433.47	36.398	61.85	60.86	57.34
981120074542	30	3433.44	36.398	61.85	60.86	57.34
981120074612	30	3433.46	36.398	61.85	60.87	57.35
981120074642	31	3433.49	36.398	61.85	60.87	57.35
981120074712	30	3433.50	36.398	61.85	60.87	57.35
981120074742	30	3433.46	36.398	61.85	60.88	57.35
981120074812	31	3433.47	36.398	61.85	60.88	57.35
981120074842	30	3433.41	36.398	61.85	60.88	57.36
981120074912	30	3433.44	36.398	61.85	60.88	57.36
981120074942	31	3433.41	36.398	61.85	60.88	57.36
981120075012	30	3433.36	36.397	61.85	60.88	57.36
981120075042	30	3433.35	36.397	61.85	60.88	57.37
981120075112	30	3433.41	36.398	61.85	60.88	57.37
981120075142	29	3433.41	36.398	61.85	60.88	57.37
981120075212	29	3433.39	36.397	61.85	60.88	57.37
981120075242	32	3433.37	36.397	61.85	60.88	57.38
981120075312	30	3433.41	36.398	61.85	60.88	57.38
981120075342	30	3433.39	36.397	61.85	60.88	57.38
981120075412	31	3433.40	36.398	61.85	60.88	57.38
981120075442	30	3433.37	36.397	61.85	60.88	57.38

Slow decrease in vol.

981120075512	30	3433.34	36.397	61.85	60.89	57.38
981120075542	31	3433.35	36.397	61.85	60.88	57.39
981120075612	31	3433.38	36.397	61.85	60.88	57.39
981120075642	30	3433.31	36.397	61.85	60.88	57.39
981120075712	30	3433.31	36.397	61.85	60.88	57.40
981120075742	30	3433.29	36.397	61.85	60.88	57.40
981120075812	31	3433.29	36.397	61.85	60.88	57.40
981120075842	30	3433.30	36.397	61.85	60.88	57.41
981120075912	30	3433.27	36.397	61.85	60.88	57.41
981120075942	30	3433.28	36.397	61.85	60.88	57.41
981120080012	30	3433.30	36.397	61.85	60.88	57.41
981120080042	30	3433.26	36.397	61.85	60.88	57.42
981120080112	31	3433.23	36.397	61.85	60.88	57.42
981120080142	30	3433.13	36.396	61.85	60.89	57.42
981120080212	31	3433.14	36.396	61.85	60.89	57.42
981120080242	30	3433.12	36.396	61.85	60.89	57.42
981120080312	30	3433.05	36.396	61.85	60.89	57.42
981120080342	31	3433.04	36.396	61.85	60.89	57.42
981120080412	30	3433.10	36.396	61.85	60.89	57.41
981120080442	31	3433.07	36.396	61.85	60.89	57.41
981120080512	30	3433.08	36.396	61.85	60.90	57.40
981120080542	30	3433.08	36.396	61.85	60.90	57.40
981120080612	30	3433.06	36.396	61.85	60.90	57.40
981120080642	31	3433.04	36.396	61.85	60.90	57.39
981120080712	31	3433.06	36.396	61.85	60.90	57.39
981120080742	30	3432.99	36.395	61.85	60.90	57.39
981120080812	30	3432.99	36.395	61.85	60.90	57.39
981120080842	31	3433.00	36.395	61.85	60.90	57.40
981120080912	30	3433.03	36.396	61.85	60.90	57.40
981120080942	31	3433.02	36.396	61.85	60.89	57.40
981120081012	30	3433.04	36.396	61.85	60.89	57.40

MOVING AVERAGE: 3433.07

DISPENSE STATE: IDLE 0.097659

Analysis

Examining the IA54 table showed that following a dispense the level continued dropping for a long period of time. Inspecting the probe revealed that the floats had been installed upside down.

Solution

Reinstall floats correctly and delete rate table.

