

# TLS-450 Setup and Operation

## Screens Manual

# Notice

---

Veeder-Root makes no warranty of any kind with regard to this publication, including, but not limited to, the implied warranties of merchantability and fitness for a particular purpose.

Veeder-Root shall not be liable for errors contained herein or for incidental or consequential damages in connection with the furnishing, performance, or use of this publication.

Veeder-Root reserves the right to change system options or features, or the information contained in this publication.

This publication contains proprietary information which is protected by copyright. All rights reserved. No part of this publication may be modified or translated to another language without the prior written consent of Veeder-Root.

Contact TLS Systems Technical Support for additional troubleshooting information at 800-323-1799.

## **DAMAGE CLAIMS / LOST EQUIPMENT**

Thoroughly examine all components and units as soon as they are received. If any cartons are damaged or missing, write a complete and detailed description of the damage or shortage on the face of the freight bill. The carrier's agent must verify the inspection and sign the description. Refuse only the damaged product, not the entire shipment.

Veeder-Root must be notified of any damages and/or shortages within 30 days of receipt of the shipment, as stated in our Terms and Conditions.

## **VEEDER-ROOT'S PREFERRED CARRIER**

1. Contact Veeder-Root Customer Service at 800-873-3313 with the specific part numbers and quantities that were missing or received damaged.
2. Fax signed Bill of Lading (BOL) to Veeder-Root Customer Service at 800-234-5350.
3. Veeder-Root will file the claim with the carrier and replace the damaged/missing product at no charge to the customer. Customer Service will work with production facility to have the replacement product shipped as soon as possible.

## **CUSTOMER'S PREFERRED CARRIER**

1. It is the customer's responsibility to file a claim with their carrier.
2. Customer may submit a replacement purchase order. Customer is responsible for all charges and freight associated with replacement order. Customer Service will work with production facility to have the replacement product shipped as soon as possible.
3. If "lost" equipment is delivered at a later date and is not needed, Veeder-Root will allow a Return to Stock without a restocking fee.
4. Veeder-Root will NOT be responsible for any compensation when a customer chooses their own carrier.

## **RETURN SHIPPING**

For the parts return procedure, please follow the appropriate instructions in the "General Returned Goods Policy" pages in the "Policies and Literature" section of the Veeder-Root North American Environmental Products price list. Veeder-Root will not accept any return product without a Return Goods Authorization (RGA) number clearly printed on the outside of the package.

## Contents

INTRODUCTION .....	1
Contractor Certification Requirements .....	1
Related Manuals.....	1
Safety Precautions .....	1
Safety Warnings .....	2
Front Panel Layout .....	3
Item 1 - Integral Printer.....	3
Item 2 - System Visual Status LEDs .....	3
Item 3 - Touch Screen.....	3
Navigating the Touch Screens.....	4
Setup, Operation, Diagnostic Touch Screen Layout .....	6
Online Help Touch screen Layout .....	8
Entering Data .....	9
Changing/Editing Values in a Field .....	9
Specialty Dialog Keypads.....	10
Initial Console Setup Sequence.....	14
Initial Startup Procedure .....	14
Startup Display .....	14
Understanding Alarms .....	16
What Happens When An Alarm Is Posted? .....	16
How Do I Silence the Console Beeper and Acknowledge the Alarm?.....	16
How Do I Learn More About an Alarm and What To Do About It? .....	17
Changing Printer Paper .....	20
SETUP SCREENS .....	21
Main Setup.....	21
Date and Time Setup.....	22
Date & Time Setup - Daylight Savings.....	22
Date & Time Setup - Date & Time Set.....	24
Display Setup - Language and Units .....	25
Display Setup - Date & Time Format .....	26
Display Setup - Number Format .....	27
Display Setup - System Status .....	28
Display - All Tanks - All Tanks Tab Advanced Setup .....	30
Display - All Tanks - Fuel Fill Selection .....	32
Display Setup - All Sensors Tab Advanced Setup .....	33
Liquid Sensors.....	33
Type A (2-wire CL) Sensors .....	34
Type B (3-wire CL) Sensors .....	34
Mag Sensors .....	34
Ground Water Sensors.....	35
Vapor Sensors.....	35
Alarm Condition Icon .....	35
Line Pressure Sensors .....	36
User Defined 1-3 Tabs.....	37
Display Setup - User Defined 1 - 3 Tabs.....	37
Headers Setup .....	38
Security - System Security.....	40
Device Setup - Probes .....	42
Device Setup - Relays .....	45
Device Setup - External Inputs .....	47
Device Setup - Liquid Sensor .....	49
Device Setup - Type A Sensor .....	51
Device Setup - Type B Sensor .....	53
Device Setup - Mag Sensor.....	55

**TLS-450 Setup and Operation Screens Manual**

Device Setup - Groundwater Sensor .....	57
Device Setup - Vapor Sensor .....	58
Device Setup - Line Pressure Sensor .....	60
Device Setup - LV/MDIM .....	61
Tank Setup - General .....	63
Tank Setup - Limits .....	67
Tank Setup - Environmental Tests .....	72
Tank Setup - All Tanks .....	78
Tank Setup - Product .....	81
Report Column Descriptions .....	81
Control Buttons (Right Side of Screen) .....	81
Tank Setup - Product Mapping .....	83
Report Column Descriptions .....	83
Control Buttons (Right Side of Screen) .....	83
Tank Setup - View All Products .....	85
Tank Setup - Chart .....	86
Tank Setup - Manual Calibration .....	88
Adding a New Manually Calibrated Tank Chart .....	89
Control Buttons (right of screen) .....	92
Tank Setup – Tank Charts .....	94
Control Buttons (right of screen) .....	95
Tank Setup - Siphon Sets .....	96
Tank Setup - AccuChart II .....	98
Pumps and Lines .....	101
PLLD Setup Overview .....	101
Pumps and Lines Setup - Pumps .....	102
Pumps and Lines Setup - Lines .....	104
Pumps and Lines Setup - All Lines .....	106
Line Lockout Schedule - Daily .....	106
Line Lockout Schedule - Individual .....	107
Pumps and Lines Setup - All PLLD .....	108
Pumps and Lines Setup - PLLD .....	110
Custom Alarms .....	114
Custom Alarms Setup - Enable .....	114
Custom Alarms Setup - View .....	115
Report Column Descriptions .....	115
Custom Alarms - Setup .....	117
Control Button (on right of screen) .....	118
Custom Help .....	119
Custom Help Setup - Enable .....	119
Custom Help Setup - Alarms .....	120
Control Buttons (on right of screen) .....	120
Inventory .....	121
Inventory Setup - Shift Close Method .....	121
Inventory Setup - Shift Times .....	123
Inventory Setup - Inventory Report Times .....	124
Delivery .....	125
Delivery Setup .....	125
Reconciliation .....	126
Reconciliation Setup - General .....	126
Reconciliation Setup - Threshold Alarms .....	128
Comm .....	131
Comm Setup - General .....	131
Console Comm Device Permissible Slots and Configurable Ports .....	131
Comm Setup Procedure .....	133



**TLS-450 Setup and Operation Screens Manual**

RS-232/RS-485, Internal Modem, Satellite Hughes H-JBox and Satellite S-Sat Comm Devices –  
General (page 1)..... 134  
    Ethernet Comm Devices – General (page 2) ..... 136  
    Ethernet Comm Devices – General (page 3) ..... 138  
    Ethernet Comm Devices – General (page 4) ..... 138  
Comm Setup - Modem..... 140  
EDIM Comm Devices – General (page 1) ..... 141  
    EDIM Comm Devices – General (page 2)..... 142  
(EDIM) Comm Setup - DIM..... 144  
CDIM Comm Devices – General (page 1) ..... 145  
    CDIM Comm Devices – General (page 2)..... 146  
Comm Setup - Advanced..... 148  
    RS-232/RS-485, Internal Modem, Satellite Hughes H-JBox, Satellite S-Sat and Ethernet Comm  
    Devices - Advanced Tab Setups ..... 148  
    EDIM Advanced Tab Setups ..... 149  
    CDIM Advanced Tab Setups (page 1) ..... 150  
    CDIM Advanced Tab Setups (page 2) ..... 151  
Comm Setup - All Comms ..... 152  
Automatic Events..... 153  
Automatic Events Setup - Address Book..... 153  
    Report Column Descriptions ..... 153  
    Control Buttons (on right of screen) ..... 154  
Add/Edit Contact Entry - Contacts ..... 155  
    Control Buttons (lower right of screen)..... 155  
Add/Edit Contact Entry - Modem ..... 156  
    Control Buttons (lower right of screen)..... 157  
Add/Edit Contact Entry - Fax ..... 158  
    Control Buttons (lower right of screen)..... 159  
Add/Edit Contact Entry - TCP/IP..... 160  
    Control Buttons (lower right of screen)..... 161  
Add/Edit Contact Entry - Satellite ..... 162  
    Control Buttons (lower right of screen)..... 163  
Add/Edit Contact Entry - Email ..... 164  
    Control Buttons (lower right of screen)..... 164  
Automatic Events Setup - Task Log ..... 165  
    Report Column Descriptions ..... 165  
    Control Buttons (on right of screen) ..... 166  
Automatic Events Setup - All Tasks ..... 167  
    Report Column Descriptions ..... 167  
    Control Buttons (on right of screen) ..... 168  
Automatic Events Setup - Device Tasks ..... 169  
    Report Column Descriptions ..... 169  
    Control Buttons (on right of screen) ..... 170  
Automatic Events - Add Tasks - Device ..... 171  
Automatic Events Setup - Print Tasks ..... 172  
    Report Column Descriptions ..... 172  
    Control Buttons (on right of screen) ..... 173  
Automatic Events Add Tasks - Print ..... 174  
Automatic Events Setup – Auto Connect Tasks..... 176  
    Report Column Descriptions ..... 176  
    Control Buttons (on right of screen) ..... 177  
Automatic Events - Add Tasks - Auto Connect ..... 178  
Meter..... 180  
Meter Setup ..... 180  
Printer Setup - Setup ..... 181  
    Printer Setup Screen 1 ..... 181

Printer Setup Screen 2 .....	182
Setup a Printer with the Get Printers Button .....	182
Setup a Network Printer with URI Field.....	183
Removing Printers .....	183
Printer Setup - Status .....	184
Printer Setup – Jobs .....	186
REPORTS.....	187
Active Alarm Report.....	187
Report Column Descriptions .....	187
Active Alarm Report Screen Refresh Rate.....	188
Control Button (on right of screen) .....	188
Alarm History Report .....	189
Report Column Descriptions .....	189
Control Buttons (on right of screen) .....	190
Priority Alarm History Report .....	191
Report Column Descriptions .....	191
Control Buttons (on right of screen) .....	192
Non-Priority Alarm History Report .....	193
Report Column Descriptions .....	193
Control Buttons (on right of screen) .....	194
Inventory Reports .....	195
Inventory Reports - Current Inventory .....	195
Report Column Descriptions .....	195
Current Inventory Report Screen Refresh Rate .....	196
Inventory Reports - Inventory History .....	197
Report Column Descriptions .....	197
Control Button (on right of screen) .....	198
Inventory Reports - Shift Inventory .....	199
Report Column Descriptions .....	199
Environmental Reports .....	201
Environmental Reports - Combined Tank Test .....	201
Report Column Descriptions .....	202
Control Buttons (on right of screen) .....	202
Regulatory Compliance .....	202
Line Leak Report Passed Test Results .....	203
Report Column Descriptions .....	203
Control Button (on right of screen) .....	204
Environmental Reports - Sensor Status .....	205
Report Column Descriptions .....	205
Environmental Reports - Sensor Status History .....	207
Screen Title Bar.....	207
Report Column Descriptions .....	207
Control Buttons (on right of screen) .....	208
Delivery Reports .....	210
Delivery Report - Manual Delivery .....	210
Report Column Descriptions .....	210
Control Buttons (Right Side of Screen) .....	211
Last Delivery Report .....	212
Report Column Descriptions .....	213
Delivery History Report.....	214
Report Column Descriptions .....	214
Control Button (on right of screen) .....	215
Delivery Report - Ticketed Delivery Report .....	216
Control Button (on right of screen) .....	217
Edit Delivery Ticket.....	218
Control Button (on right of screen) .....	219

**TLS-450 Setup and Operation Screens Manual**

Add Delivery Ticket..... 220

Delivery Report - Adjusted Delivery Report..... 222

    Report Column Descriptions ..... 222

    Control Button (on right of screen) ..... 223

BIR Reports ..... 224

Reconciliation Report - Reconciliation..... 224

    Report Column Descriptions ..... 225

    Control Buttons (on right side of screen)..... 225

Reconciliation Reports - Book Variance Report ..... 228

    Report Column Descriptions ..... 229

    Control Buttons (on right side of screen)..... 229

Reconciliation Reports - Reconciliation Test Report..... 231

    Report Column Descriptions ..... 231

    Control Buttons (on right side of screen)..... 232

DIAGNOSTIC SCREENS..... 233

Diagnostics Main Screen ..... 233

Tank Test Diagnostics ..... 234

Tank Test Diagnostics - CSLD Test Status ..... 234

    Report Column Descriptions ..... 234

    CSLD Test Status Refresh Rate ..... 235

    Regulatory Compliance ..... 235

Tank Test Diagnostics - CSLD Rate Table..... 236

    Report Column Descriptions ..... 236

    Control Buttons (right of screen) ..... 237

    Regulatory Compliance ..... 238

Tank Test Diagnostics - CSLD Monthly..... 239

    Report Column Descriptions ..... 239

    CSLD Monthly Report Refresh Rate ..... 240

    Control Buttons (on right of screen) ..... 240

    Regulatory Compliance ..... 240

Tank Test Diagnostics - SLD Last Test ..... 241

    Report Column Descriptions ..... 241

    Control Buttons (right of screen) ..... 242

    Regulatory Compliance ..... 242

Tank Test Diagnostics - SLD In-Progress ..... 243

    Report Column Descriptions ..... 243

    SLD Test In-Progress Report Refresh Rate..... 245

    Test Control Buttons (on right of screen) ..... 245

    Regulatory Compliance ..... 245

Manual Static Leak Detect screen..... 246

    Test Control Buttons (on right of screen) ..... 247

Tank Test Diagnostics - SLD History..... 248

    Report Column Descriptions ..... 248

    SLD History Report Refresh Rate ..... 249

    Control Buttons (right of screen) ..... 249

    Regulatory Compliance ..... 249

Pumps and Lines ..... 250

PLLD Diagnostics - Manual Test..... 250

    Report Column Descriptions ..... 251

    PLLD Manual Test - Refresh Rate ..... 251

    Test Control Buttons (on right of screen) ..... 251

PLLD Diagnostics - PLLD Status..... 252

    Report Column Descriptions ..... 252

    PLLD Status - Refresh Rate ..... 253

    Control Buttons (right of screen) ..... 253

PLLD Diagnostics - 3.0 gph (11.3lph) Test Results..... 254

**TLS-450 Setup and Operation Screens Manual**

Report Column Descriptions .....	254
Control Buttons (right of screen) .....	255
PLLD Diagnostics - Mid-Range Test Results .....	256
Report Column Descriptions .....	256
Control Buttons (right of screen) .....	257
PLLD Diagnostics - No-Vent Aborts .....	258
Report Column Descriptions .....	258
Control Buttons (right of screen) .....	259
PLLD Diagnostics - 0.2 gph (0.76 lph) Test Results.....	260
Report Column Descriptions .....	260
Control Buttons (right of screen) .....	261
PLLD Diagnostics - 0.1 gph (0.38lph) Test Results.....	262
Report Column Descriptions .....	262
Control Buttons (right of screen) .....	263
Tank .....	264
Tank Diagnostics - 30 Second Inventory Samples.....	264
Report Column Descriptions .....	264
30 Second Inventory Samples Refresh Rate .....	265
Meter.....	266
Meter Diagnostics - Meter Events.....	266
Control Button (Right side of Screen).....	267
Meter Diagnostics - Tank Map.....	268
Control Buttons (Right side of screen) .....	269
Meter Diagnostics - Manual Mapping .....	271
Report Column Descriptions .....	271
Control Buttons (Right side of screen) .....	272
Reconciliation.....	273
Reconciliation Diagnostics - Status .....	273
Report Column Description .....	273
Control Buttons (on right side of screen).....	274
Reconciliation Diagnostics - Reconciliation .....	275
Report Column Descriptions .....	276
Control Buttons (on right side of screen).....	277
Probe .....	278
Probe Diagnostics - General.....	278
Report Column Descriptions .....	278
Probe Diagnostics - General Screen Refresh Rate .....	279
Control Button (right of screen) .....	279
Probe Diagnostics - Reference Distance.....	280
Report Column Descriptions .....	280
Probe Diagnostics - Reference Distance Screen Refresh Rate .....	281
Control Buttons (right of screen) .....	281
Probe Diagnostics - Channel.....	282
Report Description.....	282
Probe Diagnostics Channel Refresh Rate .....	283
Control Button (right of screen) .....	283
Probe Diagnostics - Mag Options.....	284
Report Column Descriptions .....	284
Probe Diagnostics - Mag Options Screen Refresh Rate.....	285
Control Button (right of screen) .....	285
Probe Diagnostics - Communication .....	286
Report Column Descriptions .....	286
Probe Diagnostics - Communication Refresh Rate.....	287
Control Button (right of screen) .....	287
Relays & Inputs.....	288
Relays and External Inputs Diagnostics - Relays.....	288

Column Descriptions .....	289
Control Buttons (right of screen) .....	289
Sequential Testing Procedure .....	289
Inspection Testing Procedure.....	290
Relays and External Inputs Diagnostics - External Inputs.....	291
Report Column Descriptions .....	291
External Input Diagnostic Screen Refresh Rate.....	292
Control Button (right of screen) .....	292
Sensor.....	293
Sensor Diagnostics - Liquid.....	293
Report Column Descriptions .....	293
Sensor Diagnostics Liquid Sensor Refresh Rate .....	294
Control Button (right of screen) .....	294
Sensor Diagnostics - Vapor.....	295
Report Column Descriptions .....	295
Sensor Diagnostics Vapor Sensor Refresh Rate .....	296
Control Button (right of screen) .....	296
Sensor Diagnostics - Groundwater.....	297
Report Column Descriptions .....	297
Sensor Diagnostics Groundwater Sensor Refresh Rate.....	298
Control Button (right of screen) .....	298
Sensor Diagnostics - 2-Wire CL .....	299
Report Column Descriptions .....	299
Sensor Diagnostics 2-Wire CL Sensor Refresh Rate .....	300
Control Button (right of screen) .....	300
Sensor Diagnostics - 3-Wire CL .....	301
Report Column Descriptions .....	301
Sensor Diagnostics 3-Wire CL Sensor Refresh Rate .....	302
Control Button (right of screen) .....	302
Mag Sensor.....	303
Mag Sensor Diagnostics - General.....	303
Report Column Descriptions .....	303
Mag Sensor Diagnostics - General Screen Refresh Rate .....	304
Control Button (right of screen) .....	304
Mag Sensor Diagnostics - Comm.....	305
Report Column Descriptions .....	305
Mag Sensor Diagnostics - Comm Screen Refresh Rate.....	306
Control Button (right of screen) .....	306
Mag Sensor Diagnostics - Constants .....	307
Report Column Descriptions .....	307
Control Buttons (right of screen) .....	308
Mag Sensor Diagnostics - Channel .....	309
Report Description.....	309
Mag Sensor Diagnostics - Channel Screen Refresh Rate.....	310
Control Buttons (right of screen) .....	310
Line Pressure Sensor .....	311
LPR Sensor Diagnostics - General.....	311
Report Column Descriptions .....	311
Diagnostics - LPR Sensor - General screen refresh rate.....	312
Control Buttons (right of screen) .....	312
LPR Sensor Diagnostics - Communications.....	313
Report Column Descriptions .....	313
Diagnostics - LPR Sensor - Comm screen refresh rate .....	314
Control Buttons (right of screen) .....	314
LPR Sensor Diagnostics - Constants .....	315
Report Column Descriptions .....	315

Control Buttons (right of screen) .....	316
LPR Sensor Diagnostics - Channel .....	317
Report Description .....	317
Diagnostics - Line Pressure Sensor - Channel screen refresh rate .....	318
Control Buttons (right of screen) .....	318
AccuChart II .....	319
AccuChart II Diagnostics - Delivery Instructions .....	319
Report Column Descriptions .....	319
AccuChart II Diagnostics - Time Ordered Comparison .....	320
Report Column Descriptions .....	320
Control Buttons (Right side of screen) .....	321
AccuChart II Diagnostics - Histogram Comparison .....	322
Control Buttons (Right side of screen) .....	322
AccuChart II Diagnostics - Error Plot Comparison .....	323
Control Buttons (Right side of screen) .....	323
AccuChart II Diagnostics - Calibration Feedback .....	324
Report Column Descriptions .....	324
AccuChart II Diagnostics - Data Sufficiency .....	326
Control Buttons (Right side of screen) .....	327
Modules .....	328
Module Diagnostics - Hardware Configuration .....	328
Report Column Descriptions .....	328
Module Diagnostics - Device Directory .....	330
Report Column Descriptions .....	330
Module Diagnostics - Device Assignments .....	331
Report Column Descriptions .....	331
Module Diagnostics - Comm .....	333
Report Column Descriptions .....	333
Control Buttons (right of screen) .....	334
Module Diagnostics - Firmware Upgrade .....	335
Report Column Descriptions .....	335
Control Buttons (Right side of screen) .....	336
Software Maintenance .....	337
Connecting USB Thumb Drive for Software Maintenance Procedures .....	337
Software Maintenance - Backup Restore .....	340
Backup/Restore Screen Fields and Buttons .....	340
Software Maintenance - Download .....	342
Download Procedure .....	342
Download Screen Fields and Buttons .....	343
Control Buttons (Right Side of Screen) .....	343
Software Maintenance - Install .....	344
Installation Procedure .....	344
Install Screen Fields .....	345
Control Button (Right Side of Screen) .....	345
About .....	346
About - System Screen .....	346
SPECIALTY DIALOG SCREENS .....	347
Alpha Keypad Dialog .....	347
Enhanced Numeric Keypad Dialog .....	348
Numeric Keypad Dialog .....	349
Report Range Selection Dialogs .....	350
PERIODIC MAINTENANCE CHECKLIST .....	351
REFERENCES .....	355
DIM Information Tables .....	355
Table of Acronyms .....	358
Table of Alert Symbols .....	360

**TLS-450 Setup and Operation Screens Manual**

Table of Device Identifiers .....	361
Table of Module Device Identifiers .....	362
Table of Standard Abbreviations .....	362
Table of Unit Abbreviations.....	363
Table of Unit Conversions .....	364
Table of Mag Probe Features .....	364

## **INTRODUCTION**

This manual details currently available setup, operation and diagnostic screens for the TLS-450 Console. Depending on your console type and its installed features, you may only see (and be able to program) some of the screens and/or fields. Skip over the material in this document that does not apply to your particular installation. You cannot perform these setup procedures until the console, probes, and sensors have been installed and configured.



**IMPORTANT! READ ALL SECTIONS OF THE INTRODUCTION BEFORE ATTEMPTING ANY SETUP PROCEDURES.**

### **Contractor Certification Requirements**

---

Veeder-Root requires the following minimum training certifications for contractors who will install and setup the equipment discussed in this manual:

**Installer (Level 1) Certification:** Certification: Contractors holding valid Installer Certification are approved to perform wiring and conduit routing; equipment mounting; probe, sensor and carbon canister vapor polisher installation; wireless equipment installation; tank and line preparation; and line leak detector installation.

**ATG Technician (Level 2/3 or 4) Certification:** Contractors holding valid ATG Technician Certifications are approved to perform installation checkout, startup, programming and operations training, system tests, troubleshooting and servicing for all Veeder-Root Series Tank Monitoring Systems, including Line Leak Detection. In addition, Contractors with the following sub-certification designations are approved to perform installation checkout, startup, programming, system tests, troubleshooting, service techniques and operations training on the designated system.

- Wireless 2
- Tall Tank

### **Warranty Registrations:**

Warranty Registrations may only be submitted by selected Distributors.

### **Related Manuals**

---







- TLS-450 Site Prep Manual (P/N 577013-879 )
- TLS-450 Setup, Operation Screens Manual (P/N 577013-940)
- TLS-450 Quick Help Guide (P/N 577013-969)
- Electronic Line Leak Detectors Application Guide (P/N 577013-465)
- TLS Consoles Point-of-Sale (POS) Application Guide (P/N 577013-401)

### **Safety Precautions**





---

Safety and Alert Symbols are used throughout the help files to alert you to important system and safety information. The table below explains symbols you may see when reading the setup and operation instructions for this equipment.



Symbol	Definition
	<b>ELECTRICITY</b> High voltage exists in, and is supplied to, the device. A potential shock hazard exists.
	<b>EXPLOSIVE</b> Fuels and their vapors are extremely explosive if ignited.
	<b>FLAMMABLE</b> Fuels and their vapors are extremely flammable.
	<b>TURN POWER OFF</b> Live power to a device creates a potential shock hazard. Turn Off power to the device and associated accessories when servicing the unit.
	<b>WARNING</b> Heed the adjacent instructions to avoid equipment damage or personal injury.
	<b>READ ALL RELATED MANUALS</b> Knowledge of all related procedures before you begin work is important. Read and understand all manuals thoroughly. If you do not understand a procedure, ask someone who does.

## Safety Warnings

 <b>WARNING!</b>	
	<p>This system operates near highly combustible fuel storage tanks. Leaking tanks can create serious environmental and health hazards.</p> <p>If you have not been trained in proper service procedures and hazards involved, refer all service to a qualified Veeder-Root Service Representative.</p>
	<p><b>ATTEMPTING TO SERVICE TANK MONITORS AND EQUIPMENT WITHOUT PROPER TRAINING CAN CAUSE DAMAGE TO PROPERTY, ENVIRONMENT, RESULTING IN PERSONAL INJURY OR DEATH.</b></p>
	<p>Improper programming and operation may result in equipment self-test failures and submersible pump shutdowns. It is the owner's responsibility to:</p> <ol style="list-style-type: none"> <li>1. Ensure that this equipment is properly programmed.</li> <li>2. Promptly investigate any alarm conditions.</li> <li>3. Operate this equipment in accordance with the instructions in this document.</li> </ol>

## Front Panel Layout

The TLS-450 Console front panel components are shown below:

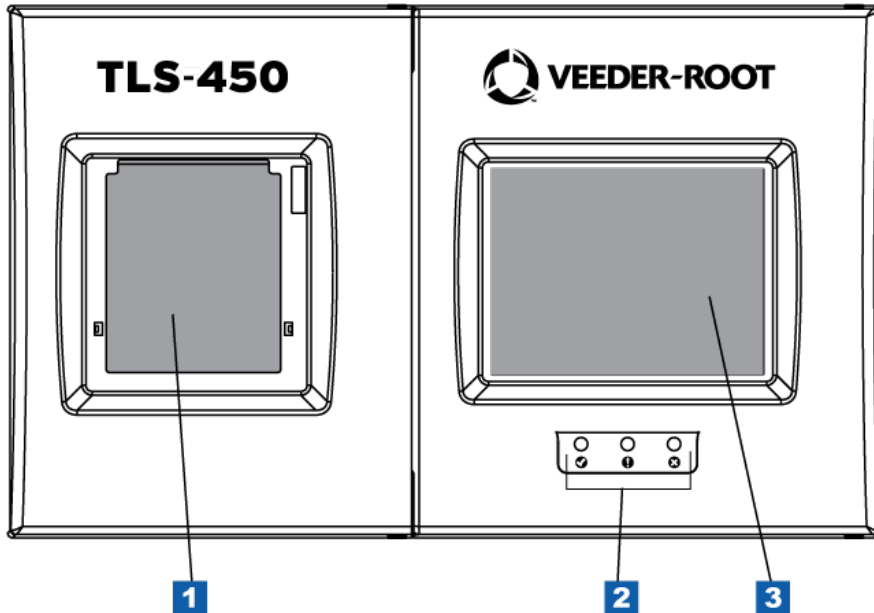

### Item 1 - Integral Printer

---

The integral printer is mounted in the left hand door of the console. The printer uses only V-R thermal roll paper (P/N 514100-456) and it must be installed correctly so the thermal sensitive side faces the print head. A red stripe will appear on the paper when it is time to change the roll.

### Item 2 - System Visual Status LEDs

---



The check symbol is beneath a green LED. When the green LED is lit, there are no alarms active (normal)



The exclamation symbol is beneath a yellow LED. When the yellow LED is lit, there is at least one warning (minor) active.



The X symbol is beneath a red LED. When the red LED is lit, there is at least one alarm (major) active.

### Item 3 - Touch Screen

---

The TLS-450 graphical user interface is a touch sensitive screen providing quick access to operational reports, setup parameters, diagnostic information for all configured devices (tanks, sensors, etc.) and Online Help.

## Navigating the Touch Screens

After power up, the TLS-450 displays the System Status - All Tanks (Home) screen (see figure below) which contains system information and access to setup, reports, and diagnostics screens as defined in the legend below the figure.

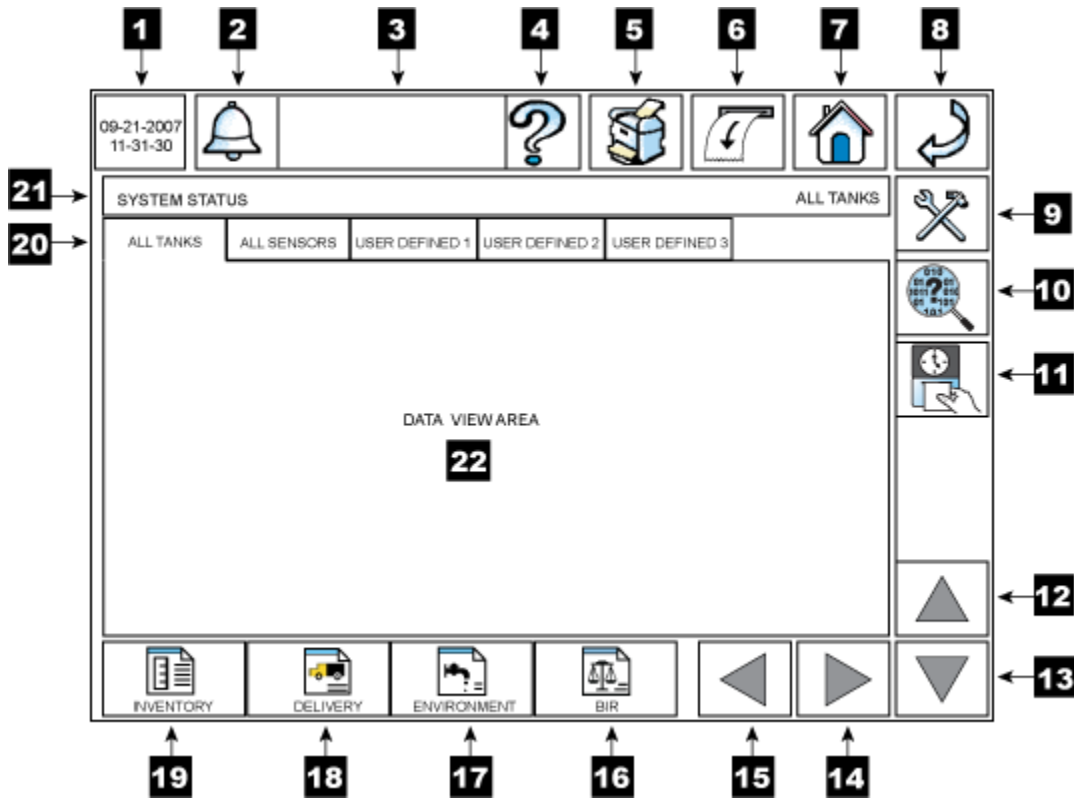

Area/Touch Button	Action/Description
1	Date and Time area displays System Time and Date. Format for time and date is configurable in the system setup area. This area is dynamic and will redraw to update the date and time display twice per second.
2	Alarm Report button - When an alarm occurs, this button will flash and the console beeper will activate. Touch this button once to display the Active Alarms Report screen. Once the Active Alarms Report screen displays, review the alarm list, then touch this button a second time to acknowledge the alarm(s), turn off the flashing System Status box and silence the beeper. Touch the Alarm Report button at any time to access all alarm reports: <ul style="list-style-type: none"> <li>- Active Alarms Report</li> <li>- Alarm History Report - All Alarms</li> <li>- Alarm History Report - Priority Alarms</li> <li>- Alarm History Report - Non-Priority Alarms</li> </ul>
3	System Status Box - The System Status box displays system alarm, warning and notice messages. If there are no active or inactive alarms, the system status

Area/Touch Button	Action/Description
	message "All Functions Normal" is displayed. When an alarm occurs, the System Status box will flash and display the alarm, warning or notice message. Once the alarms have been acknowledged, the System Status box will no longer flash. The alarm message will continue to display in the System Status box until the cause of the alarm has been corrected. When more than one alarm is active, the alarm labels will continuously scroll in the System Status box until they have been corrected.
4	<p>Help button - Touching the Help button displays the console's online help topic for the screen being viewed.</p> <p>Touch the Table of Contents  button in the upper left corner of the help screen to open the online help table of contents in which you can navigate to any online help topic.</p>
5	Print button - Touching the Print button will print the contents of the data view area to the printer designated as the default printer in Printer Setup. Nothing will print if the view is empty or printing is not relevant to that screen. If the system has no printer this button will be disabled.
6	Line-Feed button - Touching the Line Feed button will advance the printer paper about one inch (25mm).
7	Home button - Touching the Home button returns you to the System Status - All Tanks screen shown in the figure above.
8	Back button - Touching the Back button displays the previously viewed screen.
9	Setup button - Touching the Setup button displays the main System Setup Screen.
10	Diagnostic button - Touching the Diagnostic button displays the main Diagnostic Screen.
11	Shift Close button - Touching the Shift Close button displays the Shift Close dialog box in which you can choose to close the current shift for one or all tanks.
12	Scroll Up button - Touch the Scroll Up button to scroll upward through the contents of the Data View area in batches that will fit in the data view area of the display. It will be Enabled/Disabled based on Records or Data available for display.
13	Scroll Down button - Touch the Scroll Down scroll button to scroll downward through the contents of the Data View area in Batches that will fit in the data view area of the display. It will be Enabled/Disabled based on Records or Data available for display.
14	Scroll Right button - When the number of data report columns or bottom row device buttons is greater than can be shown at once, touch this button to scroll right to access off-screen data/devices. This button will be disabled unless necessary.
15	Scroll Left button - When the number of data report columns or bottom row device buttons is greater than can be shown at once, touch this button to scroll left to access off-screen data/devices. This button will be disabled unless necessary.
16	<p>BIR Report button - Touching this button accesses the following Reconciliation Reports:</p> <ul style="list-style-type: none"> <li>- Reconciliation Report</li> <li>- Book Variance Report</li> <li>- Reconciliation Test Report</li> </ul>
17	<p>Environmental Report button - Touching this button accesses the following Environmental Reports:</p> <ul style="list-style-type: none"> <li>- Combined Tank Test Report</li> <li>- Static Leak Test Report</li> <li>- Line Leak Test Report</li> <li>- Sensor Status Report</li> <li>- Sensor History Report</li> </ul>

Area/Touch Button	Action/Description
18	Delivery Report button - Touching this button accesses the following Delivery Reports: - Manual Delivery Report - Adjusted Delivery Report - Ticketed Delivery Report
19	Inventory Report button - Touching this button accesses the following Inventory Reports: - Current Inventory Report - Inventory History Report - Shift Inventory Report - Shift Inventory History Report
20	Tab Screen buttons - Touching any of the Tab Screen buttons displays the related screen: - All Tanks current status screen - All Sensors current status screen - User Defined 1, 2, 3 (user configured) status screens
21	Title Bar - The title bar area will always be present and will provide text to help identify the current screen in the Data View area. Information related to the name of the screen, selected tab screen name, and specific device or object being displayed will be present. The right side of the title bar contains additional title information. Often this is the name or label of a selected item.
22	Data View area - The Data View area displays the requested report, setup fields, etc.

**Setup, Operation, Diagnostic Touch Screen Layout**

The top button row of all console screens is shown below. The Date/time box on the left and the touch buttons to the right are present across all screens.



When you are viewing Setup or Diagnostic screens, the buttons below the data view area will represent the configured or active (communicating) devices (see example below for Tank Setup). You touch a device's button and then access setup parameters or diagnostic information for that device (Tank 3 is selected in the example below).

# TLS-450 Setup and Operation Screens Manual

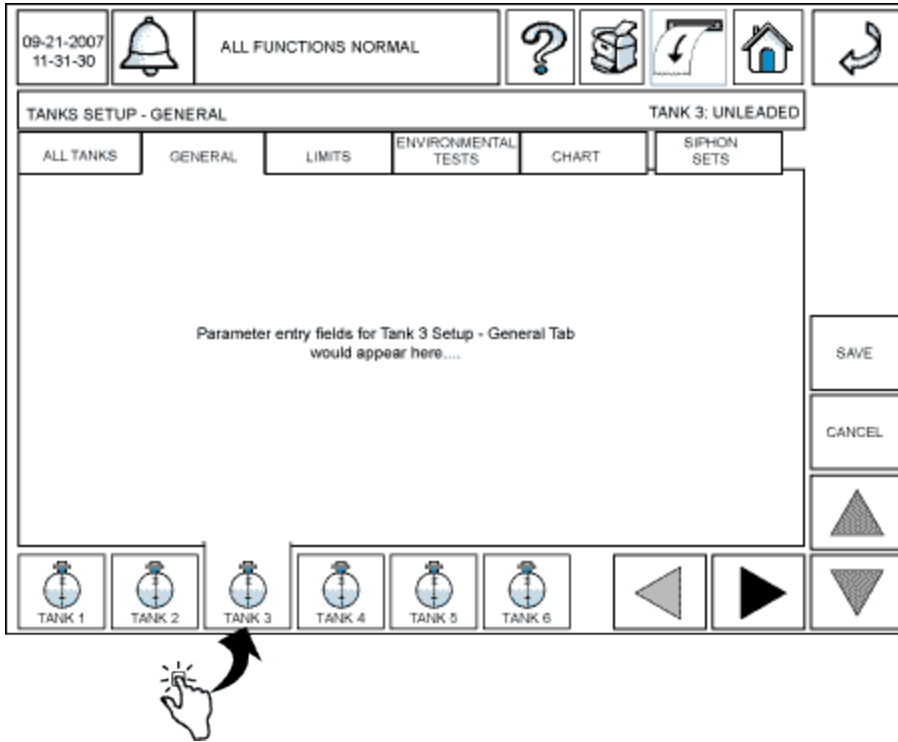

The data area displays the information associated with any selected setup, report or diagnostic screen. Tabs at the top of the data area (All Tanks, All Sensors, User Defined 1, etc. in the diagram below), if present, provide access to related data screens when touched.



## **Online Help Touch screen Layout**

---

Touching the help (?) button at the top of any Setup, Report (Operation) or Diagnostic screen displays the online help topic for that screen.

The help screen layout is shown below:

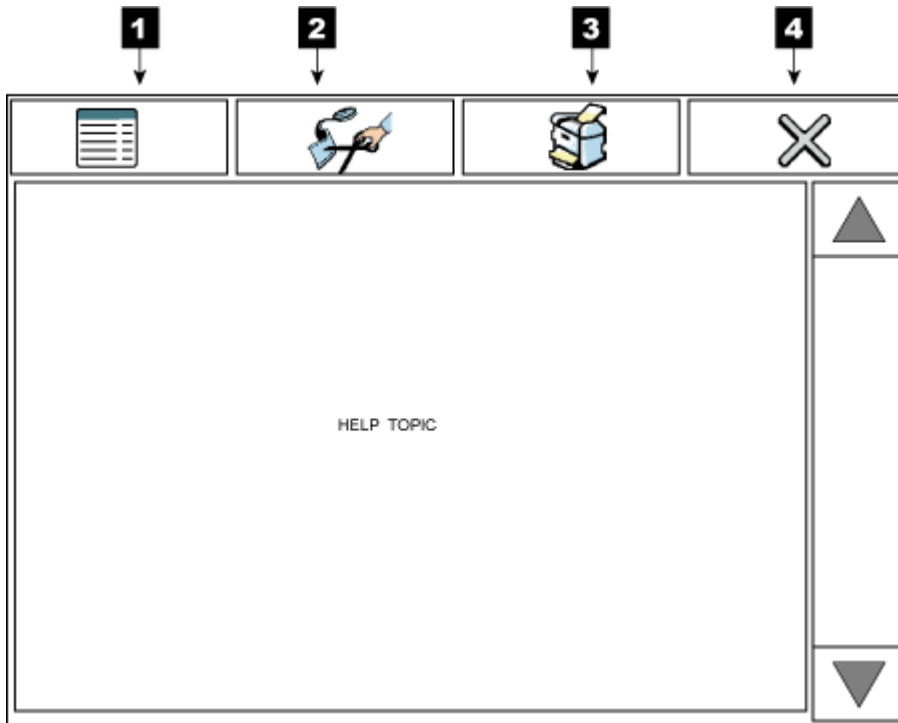

### **Item 1 - Online Help Table of Contents button**

Touch this button to display the online help table of contents. When in the table of contents you can scroll through it and select any topic for display.

### **Item 2 - Edit Help button**

If this feature is enabled, you can touch this button to view/add your own text to the default text for any selected help topic. Custom entered text will display at the top of the topic's default text. If this feature is disabled, the Edit Help button will not be visible.

### **Item 3 - Print button**

Touch this button to print the selected help topic on the optional console printer.

### **Item 4 - Close Help button**

Touch this button to close the online help screen and return to the previously viewed console screen.



## Entering Data

You enter setup parameters, confirm/cancel setup field entries, select reports, etc., using any one of a variety of touch buttons, drop-down lists and specialty dialog boxes that are easy to understand and use.

### Changing/Editing Values in a Field

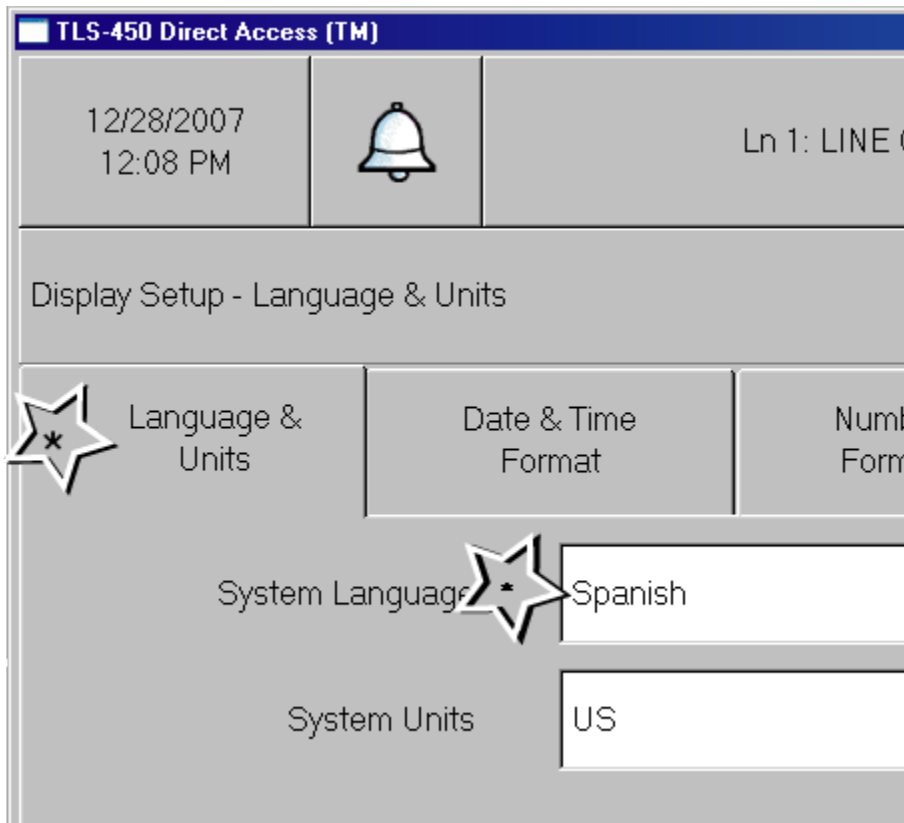
When you make an entry or change to a field on a screen, an asterisk (\*) is displayed on the currently viewed tab and beside the edited field (see star highlights in example below):



Touch the Check button  to accept your entry/change or touch the Cancel button  to undo your entry/change.

If you try and leave the screen after editing a field, but before saving your change, a Save dialog box will display, forcing you to either save or cancel your edit before leaving the screen.



## Specialty Dialog Keypads

The Specialty Dialogs section of the online help describes the function of all buttons on each of the following keypads - there are some multi-function buttons in these keypads which you should understand before using them:

### Alpha Entry Keypad

The Alpha Keypad dialog lets you enter letters of the alphabet for labels, names, etc.\

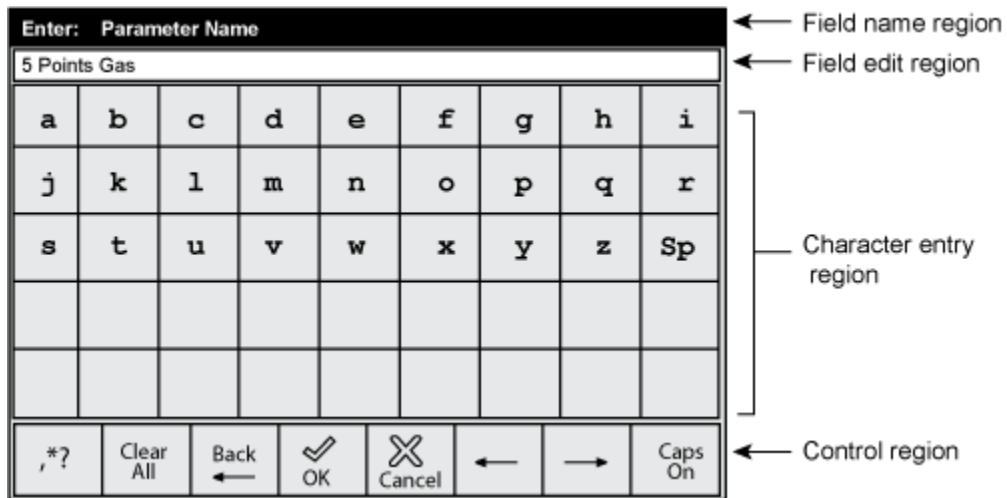

- **Field Name Region**

This is the title area that displays the name of the field value being entered.

- **Field Edit Region**

This is the view area to show the value as it is being entered (entries are left justified).

- **Character Entry Region**

This region has Buttons that enter characters in the Field Edit Line.

- **Control Region**

The region has the following buttons, from left to right:

- **,\*?** - touch this button to toggle between the Enhanced Numeric and Alpha keypad interfaces. It is enabled when the field is an Alphanumeric Entry. It is disabled if the field is an Alpha only entry.
- **Clear All** - touch this button to clear the entire entry.
- **Back** - touch this button to remove a character to the left of the cursor.
- **OK** - touch this button to apply the selection.

- **Cancel** - touch this button to discard any selections that have been made.
- ← touch this button to move the cursor to the left.
- → touch this button to move the cursor to the right.
- **Caps On** - touch this button to turn on or off caps.

### **Numeric Entry Keypad**

The Numeric Keypad dialog will display when you are required to enter integer and decimal entries:

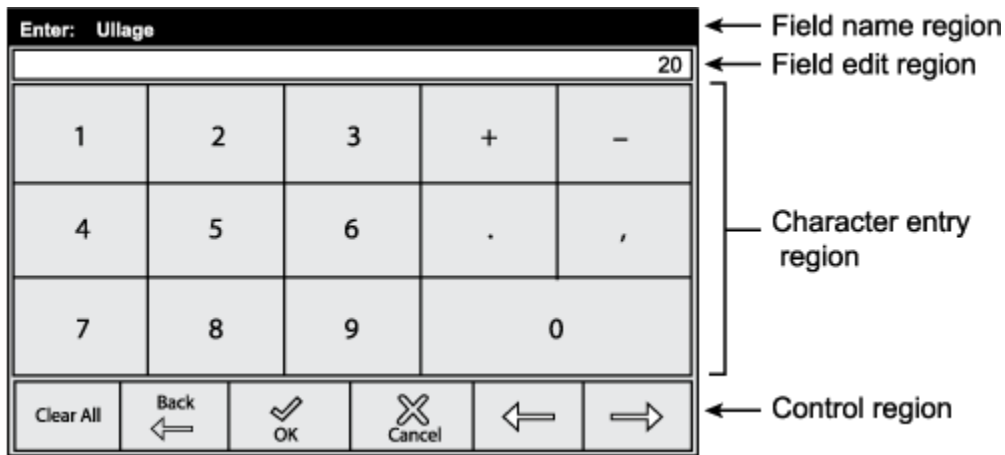

- **Field Name Region**  
This is the title area that displays the name of the field value being entered.
- **Field Edit Region**  
This is the view area to show the value as it is being entered (entries are right justified).
- **Character Entry Region**  
This region has Buttons that enter characters in the Field Edit Line.
- **Control Region**  
The region has the following buttons, from left to right:
  - **Clear All** - touch this button to clear the entire entry.
  - **Back** - touch this button to remove a character to the left of the cursor.
  - **OK** - touch this button to apply the selection.
  - **Cancel** - touch this button to discard any selections that have been made.
  - ← touch this button to move the cursor to the left.
  - → touch this button to move the cursor to the right.

Notes:

- Touching the '+' and '-' buttons will toggle the sign of the number between positive and negative. The negative sign character will be shown to the left of the numeric entry. The positive sign will not be shown. It will be disabled if range for value does not include negative numbers.
- Touching the ',' button will insert a comma for entries that use thousands separators. This button will be enabled or disabled based on the thousands separator setting in number format section of Display Setup.

**Enhanced Numeric Entry Keypad**

The Enhanced Numeric Keypad dialog provides characters that contain numeric and punctuation characters used by the alpha numeric fields for the currently selected language. This dialog is used to enter alpha numeric fields and special alpha numeric fields like phone numbers, IP addresses, etc.

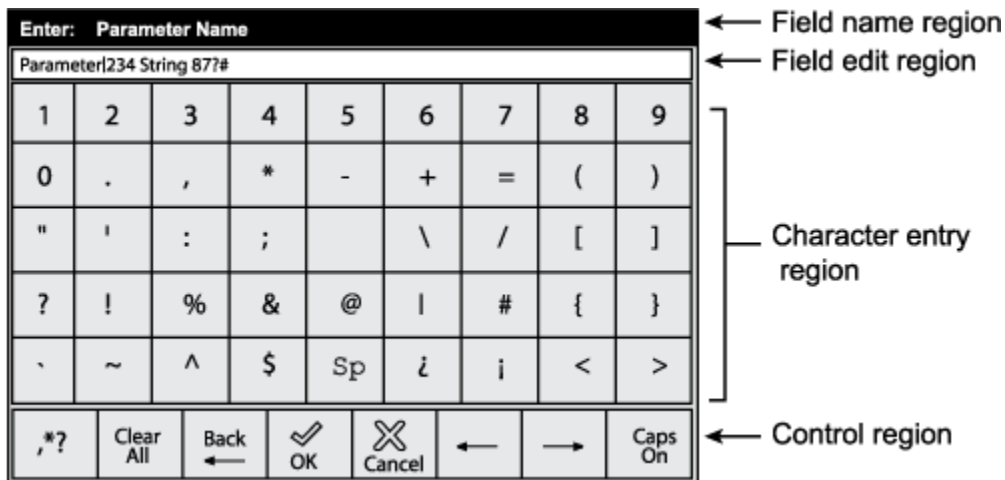

• **Field Name Region**

This is the title area that displays the name of the field value being entered.

• **Field Edit Region**

This is the view area to show the value as it is being entered (entries are left justified). The text will be left justified for both alphanumeric and enhanced numeric entries and right justified for both numeric and hexadecimal entries.

• **Character Entry Region**

This region has Buttons that enter characters in the Field Edit Line. The 'Sp' button enters a Space Character.

• **Control Region**

The region has the following buttons, from left to right:

- ,\*? - touch this button to toggle between the Enhanced Numeric and Alpha keypad interfaces. It is enabled when the field is an Alphanumeric Entry. It is disabled if the field is an Alpha only entry.

## **TLS-450 Setup and Operation Screens Manual**

- **Clear All** - touch this button to clear the entire entry.
- **Back** - touch this button to remove a character to the left of the cursor.
- **OK** - touch this button to apply the selection.
- **Cancel** - touch this button to discard any selections that have been made.
- **←** touch this button to move the cursor to the left.
- **→** touch this button to move the cursor to the right.
- **Caps On** - touch this button to turn on or off caps.

NOTE: The '¿' and '¡' symbols and other language specific punctuation characters will only show up for languages that need them.

## Initial Console Setup Sequence

Install all modules and Comm devices in the console. Install and connect all devices to the console. Connect necessary cabling to the Comm devices. Connect power wiring to the console.

### Initial Startup Procedure

---

#### A site that has a brand new TLS-450 without Wireless 2 devices

1. Power up the TLS-450 Console and wait 5 minutes until the device 'Discover Mode' is Complete.
2. Setup the TLS-450 Console

#### A site that has a brand new TLS-450 with Wireless 2 devices

1. Power up all wireless devices.
2. Power up the TLS RF Console and wait about 5 minutes, before applying power to the TLS-450.
3. Power up the TLS-450 Console and wait 5 minutes until the device 'Discover Mode' is Complete.
4. Setup the TLS-450 Console.

### Startup Display

---

The System Status - All Tanks screen (home screen) is the initial screen to display after powering up the console (see example below):

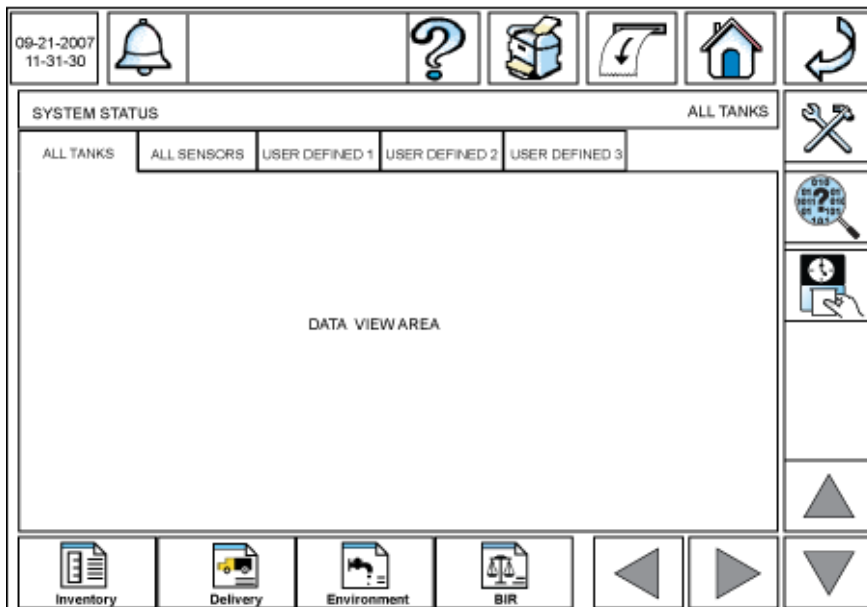

Touch the Setup button  to access the System Setup screen and perform the initial console setup following the sequence below:

## **TLS-450 Setup and Operation Screens Manual**

1. Date and Time Setup
2. Headers Setup
3. Display Setup
4. Devices (probes, sensors, relays) Setup
5. Communication Setup
6. Tanks Setup (in order of the Tab Screens left to right)
7. Pumps and line Setup (in order of the Tab Screens left to right)
8. Automatic Events Setup - do after above setups - make sure communications is setup first - do address book first
9. Custom Alarms Setup
10. Custom Help Setup
11. Security Setup
12. Inventory Setup
13. Delivery Setup
14. Reconciliation Setup
15. Printer Setup

## Understanding Alarms

### What Happens When An Alarm Is Posted?

---

When the console posts an alarm, the console beeper sounds, the front panel LED associated with the alarm type lights, the Alarm Report button/System Status box both flash and the System Status box displays the alarm label (see example below):

#### NORMAL CONDITION

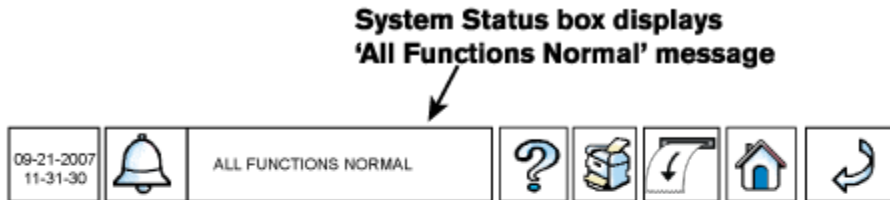

#### ALARM CONDITION

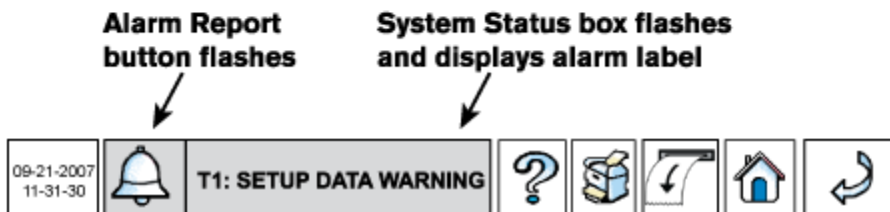

The Alarm Report button and System Status box will continue to flash until you acknowledge the alarm(s). The warning and alarm label(s) will continue to display (scroll) in the System Status box until you correct the cause of the problem.

If your system has a printer, and it has been programmed to do so, reports will be printed of programmed alarm events and notifications. Reference the [Automatic Events Add Tasks - Print](#) topic.

NOTE: Each of the alarm notification annunciators discussed above can be turned off in [Custom Alarm Setup](#), but the factory default setting is all enabled.

### How Do I Silence the Console Beeper and Acknowledge the Alarm?

---

Touch the flashing Alarm Report button to display the Active Alarm Report (see example below):

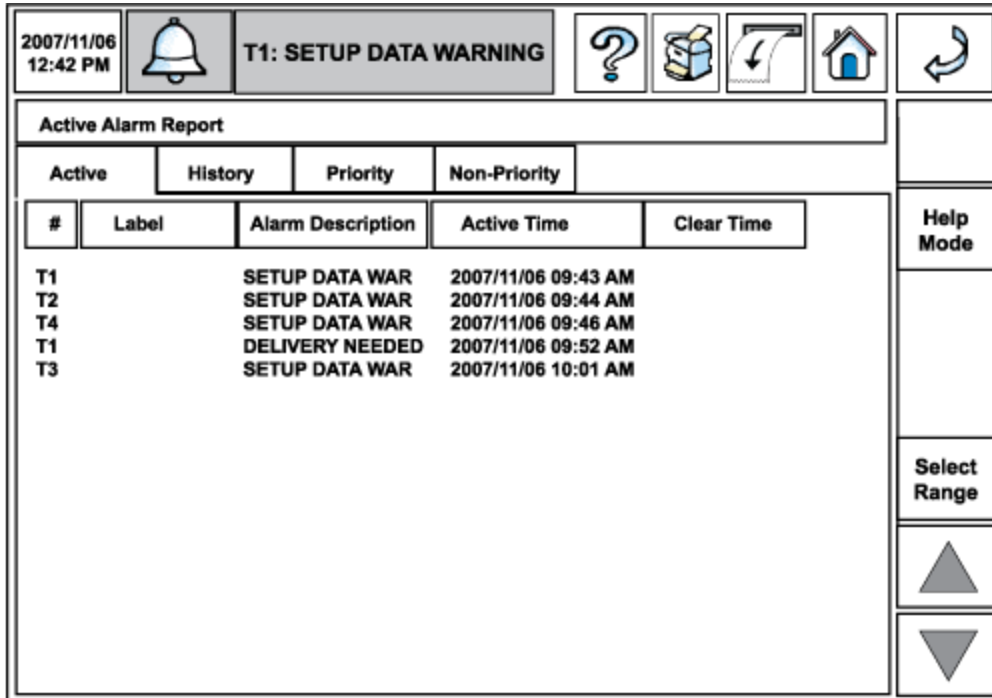

The Active Alarm Report screen shows all active and unacknowledged alarms and warnings. Once you have examined this list, touch the Alarm Report button a second time to acknowledge the unacknowledged alarms and silence the console beeper (the Alarm Report button and System Status box will also stop flashing when you acknowledge alarms). Acknowledging alarms does not clear them, that requires fixing the cause of the alarm.

### **How Do I Learn More About an Alarm and What To Do About It?**

You can access all alarm reports (Active, History, Priority and Non-Priority) at any time by touching the Alarm Report button. The Active Alarm Report is the first screen to display. To learn more about any of the alarms on the Active Alarm Report screen, touch the Help Mode button on the upper right of the data view area and the report's rows of alarms become more separated in the Alarm Help Mode screen (see example below):



2007/11/06 12:42 PM		T1: SETUP DATA WARNING					
Active Alarm Report							
Active	History	Priority	Non-Priority				
#	Label	Alarm Description	Active Time	Clear Time	Help Mode		
T1		SETUP DATA WAR	2007/11/06 09:43 AM				
T2		SETUP DATA WAR	2007/11/06 09:44 AM				
T4		SETUP DATA WAR	2007/11/06 09:46 AM				
T1		DELIVERY NEEDED	2007/11/06 09:52 AM				
T3		SETUP DATA WAR	2007/11/06 10:01 AM		Select Range		

Next touch anywhere in the desired alarm's row to display an Alarm Help screen in which its cause and a suggested corrective action are shown (see Delivery Needed alarm example below):

DELIVERY NEEDED



**CAUSE**  
Product level dropped below preset limit.



**ACTION**  
Call for delivery.

*NOTE: This alarm message will continue to display (scroll) in the System Status box until you correct the cause of the problem.*

**More About Active Alarms**

You can touch the More About Active Alarms link at the bottom of the Alarm Help screen to display a screen that contains, in addition to a quick alarm response overview, the warning shown below:

<b>⚠ WARNING!</b>	
	<b>This system operates near highly combustible fuel storage tanks. Leaking tanks can create serious environmental and health hazards.</b>
	<b>If you have not been trained in proper service procedures and hazards involved, refer all service to a qualified Veeder-Root Service Representative.</b>
	<b>Attempting to service tank monitors and equipment without proper training can cause damage to property, environment, resulting in personal injury or death.</b>

Touch the Cancel button  at the top of the Alarm Help screen to return to the Alarm Help Mode screen. Touch the Previous button  in the Alarm Help Mode screen to exit the Active Alarm Report.

## **Changing Printer Paper**

The integral printer is mounted in the left-hand door of the console. The printer uses only V-R thermal roll paper (P/N 514100-456) and it must be installed correctly so the thermal sensitive side faces the print head. A red stripe will appear on the paper when it is time to change the roll.

### **To add/replace a paper roll:**

1. Lower the front panel paper cover (it rotates down and into the door).
2. Flip the lever to the right of the small paper feed roller down to disengage it.
3. Remove the paper from the printer by clasping both sides of the paper where it goes under the small paper feed roller and gently pulling out and down.
4. Remove and discard the old roll of paper.
5. Unfasten the end of a fresh roll of paper and insert the roll into the paper tray with the end of the paper tail facing you from the bottom of the roll.
6. Pull the tail out, up and over the new roll and push the tail under the small paper feed roller until it exits above the small feed roller. Pull the tail out from the small paper feed roller a few inches, and after checking the paper for proper alignment, flip the lever up to engage the roller.

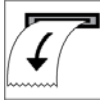

7. Touch the Line Feed button  to advance the paper a few lines and verify the paper is feeding correctly. Close the printer cover.

## SETUP SCREENS

### Main Setup

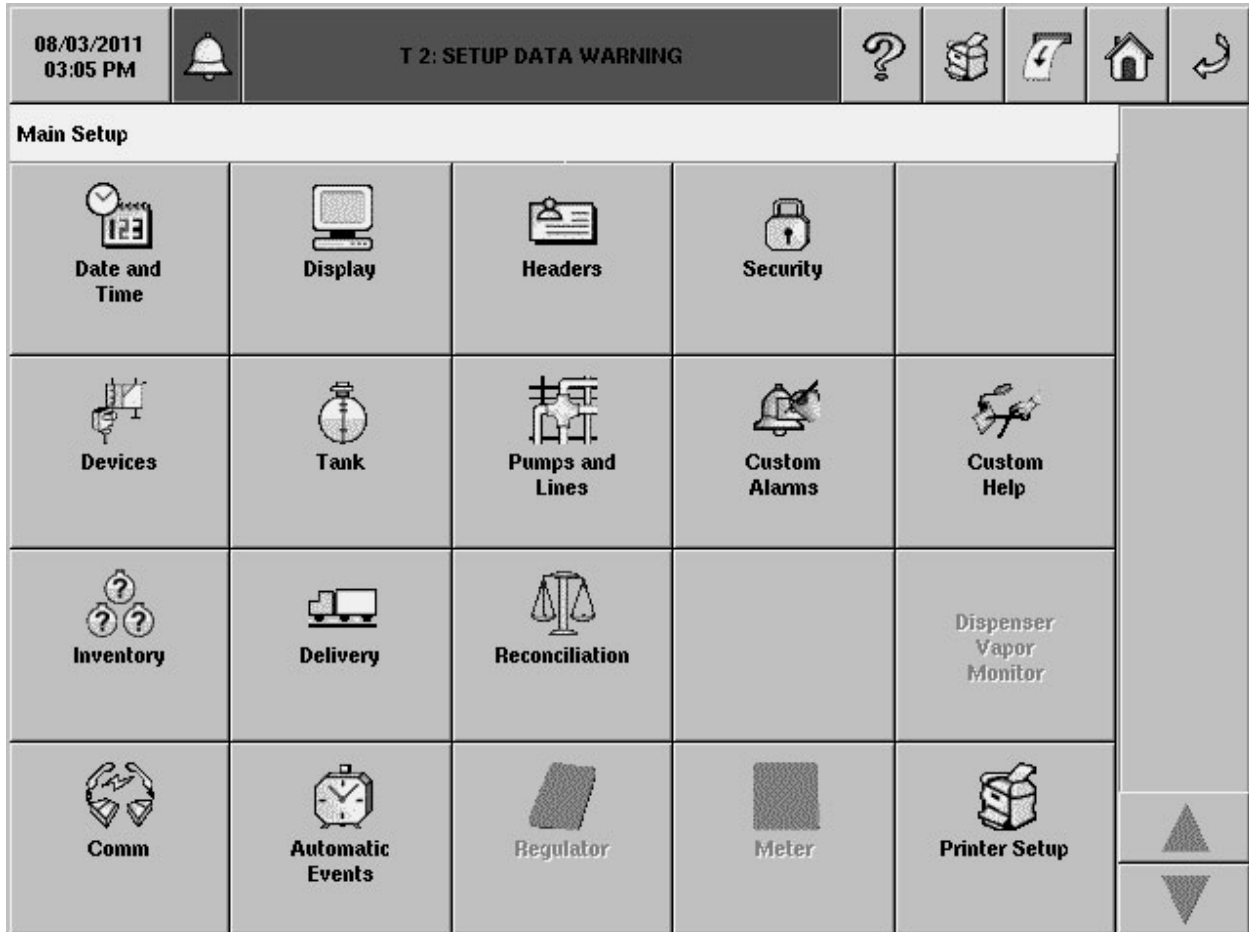

The Main Setup menu screen contains touch button navigators to all device setups in the console. If a button is dimmed, it is a disabled feature that is unavailable. Available system setups are discussed below.

NOTE: the term 'tab screen' as used herein, refers to the labeled tab visible at the top of a data area of a screen, which when touched, opens the related screen.

## Date and Time Setup

07/10/2008 11:08 AM		All Functions Normal					
<b>Date &amp; Time Setup - Daylight Savings</b>							
<b>* Daylight Savings</b>	<b>Date &amp; Time Set</b>						
Feature *	Enabled						
Start Date	MAR 2ND WEEK SUN						
Start Time	02:00 AM						
End Date	NOV 1ST WEEK SUN						
End Time	02:00 AM						

### Date & Time Setup - Daylight Savings

This section contains the Daylight Savings time setup for the console.

Most of the United States begins Daylight Saving Time at 2:00 a.m. on the second Sunday in March and reverts to Standard Time on the first Sunday in November. In the U.S., each time zone switches at a different time.

In the European Union, Summer Time begins and ends at 1:00 a.m. Universal Time (Greenwich Mean Time). It begins the last Sunday in March and ends the last Sunday in October. In the EU, all time zones change at the same moment.

#### Feature

This field lets you enable or disable daylight savings time.

Allowable Selection: Enabled/Disabled

Default: Disabled

#### Start Date

Allowable Selections: See below. Default: MAR SECOND WEEK SUN

**Select Month**

Allowable Selections: January – December. Default: MAR

**Select Week Number**

Allowable Selections: First, Second, Third, Fourth, Last. Default: SECOND

**Select Day of Week**

Allowable Selections: Sunday – Saturday. Default: SUN

**Start Time**

Allowable Selections: See below. Default: 02:00 AM

**Hours**

Allowable Selections: 0 to 23 (or 1 to 12 if 12 Hr Format)

**Minutes**

Allowable Selections: 0 to 59

**AM/PM (if 12 Hr Format)**

Allowable Selections: AM, PM

**End Date**

Allowable Selections: See below. Default: NOV FIRST WEEK SUN

**Select Month**

Allowable Selections: January – December. Default: NOV

**Select Week Number**

Allowable Selections: First, Second, Third, Fourth, Last. Default: FIRST

**Select Day of Week**

Allowable Selections: Sunday – Saturday. Default: SUN

**End Time**

Allowable Selections: See below. Default: 02:00 AM

**Hours**

Allowable Selections: 0 to 23 (or 1 to 12 if 12 Hr Format)

**Minutes**

Allowable Selections: 0 to 59

**AM/PM (if 12 Hr Format)**

Allowable Selections: AM, PM

## Date & Time Setup - Date & Time Set

07/10/2008 11:09 AM

All Functions Normal

Daylight Savings

Date & Time Set

Set Current Date 07/10/2008

Set Current Time 11:09 AM

This screen lets you enter the current Date and Time for the console.

### Set Current Date

Enter the current date.













Allowable selections: Month: 1 - 12, Day: 1 - 31, Year: 1970 - 2038  
Default: Today's date

### Set Current Time

Enter the current time.

Allowable Range: Hour: 0 - 23 (or 1 - 12 if 12 Hr Format), Minute: 0 - 59, AM, PM (if 12 Hr Format)  
Default: Today's time

## Display Setup - Language and Units

07/10/2008 11:11 AM		All Functions Normal					
Display Setup - Language & Units							
Language & Units	Date & Time Format	Number Format	System Status				
System Language	English 						
System Units	English 						
							
							
							
							

The Display Setup - Language and Units screen lets you select the language and units to be used in all screens and print outs.

### System Language

Allowable selections: English, Chinese, French, or Spanish  
Default: English

### System Units

Allowable selections: U.S., or Metric  
Default: U.S.



## Display Setup - Date & Time Format

07/10/2008 11:12 AM		All Functions Normal					
Display Setup - Date & Time Format							
Language & Units	Date & Time Format	Number Format	System Status				
Date Format	mm_dd_yyyy						
Date Separator	/						
Time Format	12-hour xM						

The Display Setup - Date & Time Format screen lets you select the date format to be used in all screens and print outs.

### Date Format

Allowable selections: YYYY\_MM\_DD, DD\_MM\_YYYY, MM\_DD\_YYYY, MON\_DD\_YYYY  
Default: MM\_DD\_YYYY

### Date Separator

Allowable selections: "/", "-", "."  
Default: "/"

### Time Format

Allowable selections: 12-hour xM (x = A or P), 24-hour  
Default: 12-hour xM

## Display Setup - Number Format

07/10/2008 11:13 AM		All Functions Normal					
Display Setup - Number Format							
Language & Units		Date & Time Format	Number Format	System Status			
Decimal Separator		<input type="text" value="."/>					
Thousands Separator		<input type="text" value="None"/>					

The Display Setup - Number Format screen lets you select the numerical separators to be used in all screens and print outs.

### Decimal Separator

Allowable selections: "," or "."

Default: "."

### Thousands Separator

Allowable selections: ",", ".", "sp" (space), or None

Default: None

## Display Setup - System Status

07/10/2008 11:14 AM		All Functions Normal						
Display Setup - System Status								
Language & Units		Date & Time Format		Number Format		System Status		
All Tanks Tab		Enabled						
All Sensors Tab		Enabled						
'User Defined 1' Tab		Enabled						
'User Defined 2' Tab		Enabled						
'User Defined 3' Tab		Enabled						

The setup for the System Status Screen enables the view of various status tabs on the home (main) screen. Available tab screens include: All Tanks, All Sensors, and up to 3 User Defined tabs in which you can assign a combination of tanks and sensors as desired.

A field to enable the display of each tab screen is present. Next to each of these tab fields is an advanced setup button. This button will launch a screen with additional choices related to the tab that has been enabled.

### All Tanks Tab

Selecting Enable in the All Tanks Tab field and then touching the Advanced Setup button  to the right of the field opens the Display - All Tanks Tab Advanced Setup screen. In this screen you select informational text and/or icons to display in the tank graphics displayed on the home screen (System Status 'All Tanks') and on any System Status 'User Defined' screens, if assigned.

Allowable selections: Enabled, Disabled  
 Default: Enabled

### **All Sensors Tab**

Selecting Enable in the All Sensors Tab field and then touching the Advanced Setup button  to the right of the field opens the Display Setup - All Sensors Tab Advanced Setup screen. In this screen you select informational text to display in the sensor graphic displayed on the home screen (System Status 'All Sensors') and on any System Status 'User Defined' screens, if assigned. The number of Sensor tabs visible will be dependent upon the types of sensors installed.

Allowable selections: Enabled, Disabled  
Default: Enabled

### **'User Defined 1' Tab**

Selecting Enable in the User Defined 1 Tab field and then touching the Advanced Setup button  to the right of the field opens the Display Setup - User Defined 1 Tab Advanced Setup screen. In this screen, you can create your own tab label as well as populate the display with your choice of tanks and sensors.

Allowable selections: Enabled, Disabled  
Default: Enabled

### **'User Defined 2' Tab**

Selecting Enable in the User Defined 2 Tab field and then touching the Advanced Setup button  to the right of the field opens the Display Setup - User Defined 2 Tab Advanced Setup screen. In this screen, you can create your own tab label as well as populate the display with your choice of tanks and sensors.

Allowable selections: Enabled, Disabled  
Default: Enabled

### **'User Defined 3' Tab**

Selecting Enable in the User Defined 3 Tab field and then touching the Advanced Setup button  to the right of the field opens the Display Setup - User Defined 3 Tab Advanced Setup screen. In this screen, you can create your own tab label as well as populate the display with your choice of tanks and sensors.

Allowable selections: Enabled, Disabled  
Default: Enabled

## Display - All Tanks - All Tanks Tab Advanced Setup

07/25/2008 02:06 PM		All Functions Normal			
Display - All Tanks			All Tanks Tab Advanced Setup		
All Tanks		Fuel Fill Selection			
		Icon Shape: Circle <input type="button" value="▼"/>			
		Product Label: Disabled <input type="button" value="▼"/>			
		Fuel Volume: Bottom Text <input type="button" value="▼"/>			
		Fuel Volume TC: Disabled <input type="button" value="▼"/>			
		Fuel Height: Enabled <input type="button" value="▼"/>			
		Water Height: Disabled <input type="button" value="▼"/>		<input type="button" value="✓"/> <input type="button" value="✕"/> <input type="button" value="▲"/> <input type="button" value="▼"/>	
Tank # Fuel Volume 5000 Fuel Height 500 Temperature 77°F					

The Display - All Tanks Tab Advanced Setup screen lets you configure informational text and/or icons (e.g., bell for alarm conditions) that will graphically represent the status of each tank. Selections made in this screen will apply to all tanks and will comprise the tank status graphic displayed on the home screen (System Status "All Tanks") and on any System Status "User Defined" status screens, if assigned.

To assist you in deciding about your choices, the changes to the tank status graphic display as you make your selections.

### Icon Shape

Allowable selections: Circle or Rectangle  
 Default: Circle

### Tank Label

Allowable selections: Enabled, Disabled  
 Default: Disabled

### Fuel Volume

Allowable selections: Disabled, Bottom Text, Text Overlay On Tank Picture  
 Default: Bottom Text

### Fuel Volume TC

Allowable selections: Enabled, Disabled  
 Default: Disabled

**Fuel Height**

Allowable selections: Enabled, Disabled. Default: Disabled

**Ullage 100%**

Allowable selections: Enabled, Disabled. Default: Disabled

**Ullage xx%**

Ullage xx% can always be selected but will only be displayed in the tank status graphic display if you enabled 'User defined ullage' in the Tank Setup - All Tanks Screen.

Allowable selections: Enabled, Disabled

Default: Disabled

**Water Height**

Note: This selection requires water measuring probes.

Allowable selections: Enabled, Disabled

Default: Disabled

**Temperature**

Allowable selections: Disabled, Bottom Text, On Tank

Default: Bottom Text

**Alarm Condition Icon**

Allowable selections: Enabled, Disabled

Default: Enabled

**Delivery Indicator**

Allowable selections: Enabled, Disabled

Default: Disabled

**Water Volume (on icon)**

Note: This selection requires water measuring probes.

Allowable selections: Disabled, Bottom Text, On Tank

Default: Bottom Text

**Tank Ribbon Label**

This selection determines what label will appear on the tank buttons along the bottom of the screen. The system assigns the actual label or number from Tank/Device setup entries.

Allowable selections: Tank Label or Tank Number

Default: Tank Number

**Density**

Note: This selection requires density measuring probe.

Allowable selections: Enabled, Disabled . Default: Disabled

## Display - All Tanks - Fuel Fill Selection

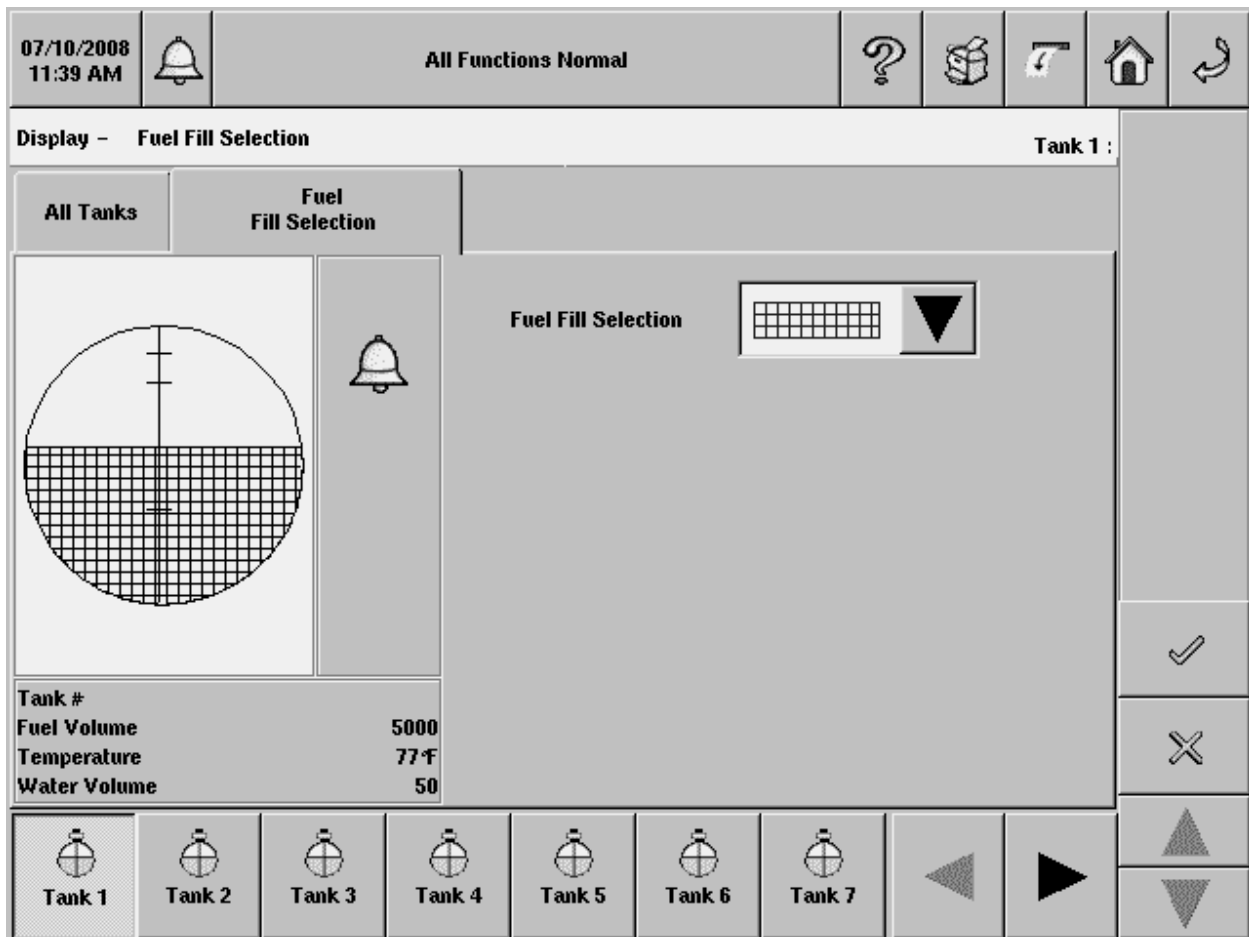

The Display - All Tanks - Fuel Fill Selection screen lets you select the pattern of the fuel in the tank status graphic.

### Fuel Fill Selection

This selection lets you configure the fuel patterns to display as fuel levels in a selected tank. Touch any tank button on the bottom of the screen, then select the desired fuel pattern for that tank. As patterns are chosen, the fuel fill area in the tank graphic will change to show the effect.

Allowable selections: Various patterns  
 Default: Fine screen

## Display Setup - All Sensors Tab Advanced Setup

07/10/2008 11:41 AM		All Functions Normal				
Display Setup - Liquid				All Sensors Tab Advanced Setup		
Liquid	Type A (2-Wire CL)	Type B (3-Wire CL)	MAG	Ground Water		
		<b>Sensor Label</b>		Disabled		
		<b>Alarm Condition Icon</b>		Enabled		
		<b>Model</b>		Enabled		
		<b>Category</b>		Enabled		
<b>Liquid #</b> <b>Model</b> <b>Category</b>		Tri State Other Sensors				

This screen lets you configure informational text and/or icons (e.g., bell for alarm conditions) that will represent the status of each sensor type. Selections made in each sensor tab screen will apply to all sensors of that type and will comprise the content of that sensor's status graphic displayed on the home screen (System Status 'All Sensors') and on any of the System Status 'User Defined' screens, if assigned. To assist you in deciding about your choices, the changes to the sensor status graphic are displayed as you make your selections.

### Liquid Sensors

#### Sensor Label

Allowable selections: Enabled, Disabled  
 Default: Disabled

#### Alarm Condition Icon

Allowable selections: Enabled, Disabled  
 Default: Disabled

#### Model

Allowable selections: Enabled, Disabled  
 Default: Disabled



**Category**

Allowable selections: Enabled, Disabled  
Default: Disabled

**Type A (2-wire CL) Sensors**

---

**Sensor Label**

Allowable selections: Enabled, Disabled  
Default: Disabled

**Alarm Condition Icon**

Allowable selections: Enabled, Disabled  
Default: Disabled

**Model**

Allowable selections: Enabled, Disabled  
Default: Disabled

**Category**

Allowable selections: Enabled, Disabled  
Default: Disabled

**Type B (3-wire CL) Sensors**

---

**Sensor Label**

Allowable selections: Enabled, Disabled  
Default: Disabled

**Alarm Condition Icon**

Allowable selections: Enabled, Disabled  
Default: Disabled

**Model**

Allowable selections: Enabled, Disabled  
Default: Disabled

**Category**

Allowable selections: Enabled, Disabled  
Default: Disabled

**Mag Sensors**

---

**Sensor Label**

Allowable selections: Enabled, Disabled  
Default: Disabled

**Alarm Condition Icon**

Allowable selections: Enabled, Disabled  
Default: Disabled

**Fuel Height**

Allowable selections: Enabled, Disabled  
Default: Disabled

**Water Height**

Allowable selections: Enabled, Disabled  
Default: Disabled

**Temperature**

Allowable selections: Enabled, Disabled  
Default: Disabled

**Ground Water Sensors**

---

**Sensor Label**

Allowable selections: Enabled, Disabled  
Default: Disabled

**Alarm Condition Icon**

Allowable selections: Enabled, Disabled  
Default: Disabled

**Category**

Allowable selections: Enabled, Disabled  
Default: Disabled

**Vapor Sensors**

---

**Sensor Label**

Allowable selections: Enabled, Disabled  
Default: Disabled

**Alarm Condition Icon**

---

Allowable selections: Enabled, Disabled  
Default: Disabled

**Category**

Allowable selections: Enabled, Disabled  
Default: Disabled

## **Line Pressure Sensors**

---

### **Sensor Label**

Allowable selections: Enabled, Disabled  
Default: Disabled

### **Alarm Condition Icon**

Allowable selections: Enabled, Disabled  
Default: Disabled

### **Pressure**

Allowable selections: Enabled, Disabled  
Default: Disabled

## **User Defined 1-3 Tabs**

### **Display Setup - User Defined 1 - 3 Tabs**

---

User Defined tab screens show a graphical status view (created in Tank/Sensor Display Setups) of selected devices in the system. You can select which devices are to be included in each of these tab screens. For the User Defined tab screen(s) the number of Tank or Sensor graphics per page is fixed - 6 for a 7.4 LCD and 8 for a 10.4 LCD.

Each configured page of a User Defined Tab screen will be accessible using the Up/Down Buttons on the lower right of the screen. A page is considered configured if it contains at least one valid device entry. Initially the setup area will show one page where none of the device positions are assigned devices.

For any page, you can select the position of the device's status graphic in the grid by selecting a device for that position. You can also leave some of the positions blank (No Device) by not making a device selection.

#### **Tab Name**

You can replace "User Defined X" with an alphanumeric name on the screen's tab. Your entry must have no control characters or punctuation (non-leading and non-trailing spaces are allowed in your entry).

Allowable selections: 1 character minimum, 15 characters maximum

Default: User Defined "X" (where X = 1, 2 or 3)

## Headers Setup

07/25/2008 02:03 PM		All Functions Normal		?				
<b>Headers Setup</b>								
Header 1	ABC GAS							
Header 2	123 Main St							
Header 3	City, USA							
Header 4	TLS-450							
Fax Sender Name	ABC FAX							
Fax Number	800-555-1234							

This section contains the four report Header Station Information fields. It also contains the options of adding a fax sender's name and fax number to the header info set. Use the header to identify site location, phone number, etc.

### Header 1

Allowable selections: Alphanumeric Text Field Length - 20 Characters  
Default: Empty

### Header 2

Allowable selections: Alphanumeric Text Field Length - 20 Characters  
Default: Empty

### Header 3

Allowable selections: Alphanumeric Text Field Length - 20 Characters  
Default: Empty

### Header 4

Allowable selections: Alphanumeric Text Field Length - 20 Characters  
Default: Empty

**Fax Sender Name**

Enter the header info to be sent at the top of faxes transmitted by the console.

Allowable selections: Alphanumeric Text Field Length - 30 Characters

Default: Empty

**Fax (Sender) Number**

Enter the phone number the console will dial from when transmitting faxes.

Allowable selections: Numeric Field Length - 40 Digits

Default: Empty

## Security - System Security

2007/11/05 02:13 PM		All Functions Normal				
Security - System Security						
Front Panel Security	Enabled					
Password	xxxxxxx					

This screen establishes front panel and web access control for the console. By enabling this security feature, Log-In /Log-Out modes are established which prevent unauthorized tampering of console setups.

### Log-In Mode

Requires the Front Panel / Web Security selection be enabled and a correct password entered by the user. In this mode you can edit console setup parameters, access diagnostic menus, view system status screens and print out end-user reports. While you remain logged in, a log out button will be visible in the lower right side of the System Status screen. Once you are logged in, timeout rules will apply as discussed below.

### Log-Out Modes

With the Front Panel / Web Security selection enabled, you must enter the correct password or remain in the Log-Out mode and only be allowed to view system status screens and print out end-user reports.

Once logged in, there are two ways of logging out:

#### Manually



You can log out of the console via the 'logout'  button found on the System Status screen's right side above the up/down arrows. This button will only appear when system security is enabled and you

are logged in. When this button is touched a Log-out dialog will display the message "Are you sure you want to Logout?"

OK - logs the current user out and returns to the System Status screen in log-out mode.

CANCEL - returns to the System Status screen without logging out.

### **Automatically**

There will be a maximum length of time you will be allowed to stay logged in without activity. User activity is defined as GUI screen interaction using touch, for an LCD display, or, GUI screen interaction using keystrokes, and mouse-clicks in the case of a PC interface, all while you are still logged in. Any touch, mouse-click or key hits on the GUI screen resets the timeout timer.

When the timeout occurs, you will be logged out and the console will return to the System Status window in log-out mode. No warning will be given before the session timeout. If the timeout occurs before you have saved changes on any parameter entry screen, these changes will be lost. No prompt will be given to save changes before you are logged out.

The default timeout for the Basic Security option is 15 minutes. This timeout is set internally and of a fixed duration.

### **Front Panel Security**

Security to the Console from the Front Panel will be enforced on Diagnostics and Setup. A Login action is always required to access those areas of the system.

Allowable selections: Enabled, Disabled

Default: Disabled

### **Password**

A case-sensitive password (alpha and enhanced numeric - also punctuation characters), no spaces allowed, no control characters. Each character will be represented by a star '\*' on the field.

Allowable selections: 3 -10 alphanumeric characters

Default: Empty



## Device Setup - Probes

07/23/2008 06:05 PM		All Functions Normal			?		?		?		?		?	
Device Setup - Probes												Probe 1 :		
Probes		Relays		External Inputs		Liquid Sensor		Type A Sensor (2-Wire CL)		◀		▶		
Configured		Enabled		▼										
Address		B1.S1.1		▼										
Label														
Serial Number		176011												
Manufacturer ID														
Probe 1		Probe 2		Probe 3		Probe 4		Probe 5		Probe 6		Probe 7		

This screen allows you to setup probes connected to the console. Only the probes and quantity enabled for your console will be configurable. You access each of your site's probe setups by touching the desired button at the bottom of the screen.

### Configured

Note:

1. Do not enable probe until its address is assigned!
2. Once enabled, do not disable probe if it is assigned to a tank. You must first unassign the probe from the tank before the probe can be disabled.

Allowable selections: Enabled, Disabled

Default: Disabled

### Address

Allowable selections: Choose from drop-down list of available probes, Not Assigned

Default: Not Assigned

### Label

Allowable selections: Up to 20 alphanumeric characters

Default: Blank

**Serial Number (Read Only)**

**Probe Type (Read only)**

**Float Type**

Enter the installed Mag probe float size. The console automatically recognizes which Mag probe type you have installed and will display only the applicable float size options. Only select "Custom" if the literature that was shipped with the float specifically states that you must choose this float size selection, i.e., Chem-ISO and LPG-ISO probes. The installation literature accompanying Chem-ISO and LPG-ISO probes will list the required values to enter.

Allowable selections: Standard Mag Probe: 4 in. (101mm), 2 in. (50mm) and Custom. Low-Level Mag Probe: 4 in. (101mm), 3 in. (76mm), 2 in. (50mm), 1 in. (25mm) and Custom. Low-Level Mag Probes - MAG7, MAG8 and MAG9: 4 in. (101mm), 3 in. (76mm), 2 in. (50mm), 1 in. (25mm), 4 in. Phase Separation and Custom.

Default: 2 in.(50mm), 3 in.(76mm) or 4 in. (101mm) depending on probe type.

Notes:

1. If the Custom float size is selected, fuel offset, invalid fuel, water offset, and water minimum parameter fields below are enabled for edit.
2. Only circuit codes, D004, D005 and D006 are allowed to set the float type to 4 in phase separation.

**Fuel Offset (Custom Float Type)**

Allowable selections: -8 in. to 8 in. (-203.2 to 203.2mm)

Default: Default varies according to Probe type and Float type. Refer to tables below for US values. Metric values are calculated using the formula; mm = 25.4 \* in.

**Water Offset (Custom Float Type)**

Allowable selections: -8 in. to 8 in. (-203.2 to 203.2mm)

Default: Default varies according to Probe type and Float type. Refer to tables below for US values. Metric values are calculated using the formula; mm = 25.4 \* in.

**Water Min. (Custom Float Type)**

Allowable selections: 0 to 10 in. (0 to 254mm)

Default: Default varies according to Probe type and Float type. Refer to tables below for US values. Metric values are calculated using the formula; mm = 25.4 \* in.

**Invalid Fuel (Custom Float Type)**

Note: The invalid fuel level assumes no water is present. If water is present, the invalid fuel level is increased by the water level reading.

Allowable selections: 0 to 10 in. (0 to 254mm)

Default: Default varies according to Probe type and Float type. Refer to tables below for US values. Metric values are calculated using the formula; mm = 25.4 \* in.

**1" & 2" CUSTOM FLOAT DEFAULTS**

Circuit Code	Name Type	2" Floats				1" Floats			
		Water Offset	Fuel Offset	Invalid Fuel	Water Min.	Water Offset	Fuel Offset	Invalid Fuel	Water Min.
C000	MAG1	-3.160	2.520	9.500	0.750	-	-	-	-
C001	MAG2	-3.160	2.520	9.500	0.750	-	-	-	-
D000	MAG3	-3.160	2.520	9.500	0.750	-	-	-	-
D001	MAG4	-	2.520	7.000	-	-	-	-	-
D002	MAG5	-	2.520	7.000	-	-	-	-	-
D003	MAG6	-	2.520	7.000	-	-	-	-	-
D004	MAG7	-1.940	0.060	3.230	0.867	-	-	-	-
D005	MAG8	-1.940	0.060	3.230	0.867	-	-	-	-
D006	MAG9	-1.940	0.060	3.230	0.867	-1.420	-0.360	5.500	1.500
D007	MAG10	-	0.060	3.000	-	-	-	-	-
D008	MAG11	-	0.060	3.000	-	-	-	-	-
D009	MAG12	-	0.060	3.000	-	-	-0.360	2.500	-
D021	GLB8	-1.940	0.060	3.230	0.867	-	-	-	-
D022	GLB9	-1.940	0.060	3.230	0.867	-	-	-	-
D023	GLB10	-	0.060	3.000	-	-	-	-	-
D024	GLB11	-	0.060	3.000	-	-	-	-	-

**3" & 4" CUSTOM FLOAT DEFAULTS**

Circuit Code	Name Type	4" Floats				3" Floats			
		Water Offset	Fuel Offset	Invalid Fuel	Water Min.	Water Offset	Fuel Offset	Invalid Fuel	Water Min.
C000	MAG1	-3.160	0.270	8.000	0.750	-	-	-	-
C001	MAG2	-3.160	0.270	8.000	0.750	-	-	-	-
D000	MAG3	-3.160	0.270	8.000	0.750	-	-	-	-
D001	MAG4	-	0.270	5.000	-	-	-	-	-
D002	MAG5	-	0.270	5.000	-	-	-	-	-
D003	MAG6	-	0.270	5.000	-	-	-	-	-
D004	MAG7	-2.170	-0.880	3.040	0.630	-2.170	-0.880	3.040	0.630
D005	MAG8	-2.170	-0.880	3.040	0.630	-2.170	-0.880	3.040	0.630
D006	MAG9	-2.170	-0.880	3.040	0.630	-2.170	-0.880	3.040	0.630
D007	MAG10	-	-1.820	0.985	-	-	-1.820	0.985	-
D008	MAG11	-	-1.820	0.985	-	-	-1.820	0.985	-
D009	MAG12	-	-1.820	0.985	-	-	-1.820	0.985	-
D021	GLB8	-2.170	-0.880	3.040	0.630	-2.170	-0.880	3.040	0.630
D022	GLB9	-2.170	-0.880	3.040	0.630	-2.170	-0.880	3.040	0.630
D023	GLB10	-	-1.820	0.985	-	-	-1.820	0.985	-
D024	GLB11	-	-1.820	0.985	-	-	-1.820	0.985	-

## Device Setup - Relays

07/23/2008 06:06 PM		All Functions Normal			?		?		?		?		?		
Device Setup - Relays											Relay 1 :		?		
Probes		Relays		External Inputs		Liquid Sensor		Type A Sensor (2-Wire CL)		◀		▶			
Configured		Enabled													
Address		B1.S4.1													
Label															
Type		Standard													
Orientation		Normally Open													
Relay 1		Relay 2		Relay 3		Relay 4		Relay 5		Relay 6		Relay 7			

This screen allows you to setup monitored relays. You must enter data individually for each relay. Alarm assignment to a relay is done in the [Automatic Events Setup - Device Tasks screen](#).

### Configured

Allowable selections: Enabled, Disabled  
Default: Disabled

### Address

Allowable selections: Choose from drop-down list of available external inputs, Not Assigned  
Default: Not Assigned

### Label

Allowable selections: Up to 20 alphanumeric characters  
Default: Blank

### Type

Enter the type of relay that is connected to the selected relay location:

- STANDARD - The On/Off state is determined by assigned alarms/warnings.
- PUMP CONTROL OUTPUT - Relay state is controlled by TLS Pump/Line controller.

## **TLS-450 Setup and Operation Screens Manual**

- **MOMENTARY** - The On/Off state is determined by assigned alarms/warnings. However, relay returns to the inactive state after the Alarm button is touched to acknowledge the alarm.
- **PUMP COMM CONTROL** - Select this relay type only when a set of line manifolded pumps are using Red Jacket IQ Controllers, and you want to run PLLD precision line leak tests. After selecting this relay type, when one IQ controlled pump of a manifolded set is turned On for line leak testing, the relay will activate, blocking communication with the second IQ controlled pump (giving the console total control of the pumps) until the precision test is complete.

Allowable selections:

- Standard
- Pump Control Output
- Momentary
- Pump Comm Control

Default: Standard

### **Orientation**

You must identify the input switch orientation as either normally open or normally closed so the console properly recognizes an ON or OFF condition.

Allowable selections: Normally Open, Normally Closed

Default: Normally Closed

## Device Setup - External Inputs

07/23/2008 06:08 PM		All Functions Normal		?		?		?		?		?	
Device Setup - External Inputs										External Input 1 :			
Probes		Relays		External Inputs		Liquid Sensor		Type A Sensor (2-Wire CL)		◀		▶	
Configured		Enabled		▼									
Address		B1.S4.2		▼									
Label				⊞									
Type		Standard		▼								✓	
Orientation		Normally Open		▼								✗	
ExtInp 1		ExtInp 2		ExtInp 3		ExtInp 4		ExtInp 5		ExtInp 6		ExtInp 7	
												▶	
												▼	

This screen allows you to setup external input devices that have been connected to the console.

### Configured

Allowable selections: Enabled, Disabled  
 Default: Disabled

### Address

Allowable selections: Choose from drop-down list of available external inputs, Not Assigned  
 Default: Not Assigned

### Label

Allowable selections: Up to 20 alphanumeric characters  
 Default: Blank

### Type

Enter the type of input - Standard, Generator, Pump Sense, or Standard ACK - that is connected to the selected input location:

- STANDARD - Select this input type to generate the External Input alarm when it's active.
- GENERATOR - Select this input type for applications where you monitor fuel tank(s) supplying an emergency generator and you receive generator ON and OFF signals from the generator. The system runs a continuous leak test in the generator's tank(s) until the generator turns On. When

the generator shuts Off, the system returns to its Leak Test mode. GENERATOR ON and GENERATOR OFF messages are printed whenever the generator turns on and off. This selection also generates the External Input alarm.

- PUMP SENSE - Select this input type when the input is used to indicate the On/Off state of the pump. This selection also indicates the 'state of hook signal'.
- STANDARD ACK - - Select this type when using an external input (e.g., remote pushbutton) as an ALARM/TEST key. This selection also generates the External Input alarm.

Allowable selections:

- Standard
- Generator
- Pump Sense
- Standard ACK

Default: Standard

### **Orientation**

You must identify the input switch orientation as either normally open or normally closed so the console properly recognizes an ON or OFF condition.

Allowable selections: Normally Open, Normally Closed

Default: Normally Closed

### **Tanks (Generator External Input Type Only)**

You must identify which tanks supply fuel to the generator, so that the console will conduct a continuous leak test in these tanks while the generator is off. If all tanks connected to the system supply fuel to the generator wired to this input, select All Tanks. If only one or some of the tanks connected to the system supply fuel to this generator, enter the individual tank numbers.

Allowable selections: All tanks, or select a tank(s)

Default: Blank

## Device Setup - Liquid Sensor

07/23/2008 06:09 PM		All Functions Normal					
Device Setup - Liquid Sensor							Sensor 1 :
Probes	Relays	External Inputs	Liquid Sensor	Type A Sensor (2-Wire CL)			
Configured	Enabled						
Address	B1.S1.13						
Label	<input type="text"/>						
Model	Tri-State(Single Float)						
Category	Other						
Liquid 1	Liquid 2	Liquid 3	Liquid 4	Liquid 5	Liquid 6	Liquid 7	

This screen allows you to setup Liquid Sensors connected to the console. You access each of your site's liquid sensor setups by touching the desired button at the bottom of the screen.

### Configured

Allowable selections: Enabled, Disabled  
Default: Disabled

### Address

Allowable selections: Choose from drop-down list of available liquid sensors, Not Assigned  
Default: Not Assigned

### Label

Allowable selections: Up to 20 alphanumeric characters  
Default: Blank



**Model**

Select the sensor's model from the drop down list.

Allowable selections:

- Tri-State (Single Float)
- Normally Closed
- Dual Point Hydrostatic
- Dual Float Discriminating
- Dual Float High Vapor
- Interceptor Sensor
- DW Sump 2-1 Sensor

Default: Tri-State (Single Float)

**Category**

Select the sensor's category (location) from the drop down list.

Allowable selections: Other Sensors, Annular Space, Dispenser Pan, Monitor Well, STP Sump, Containment Sump

Default: Other Sensors

## Device Setup - Type A Sensor

07/10/2008 11:26 AM		All Functions Normal								
Device Setup - Type A Sensor (2-Wire CL)									Sensor 1 :	
Relays	External Inputs	Liquid Sensor	Type A Sensor (2-Wire CL)							
Configured	Disabled									
Address	Not Assigned									
Label										
Model	Discrim. Interstitial									
Category	Other									
Type A 1	Type A 2	Type A 3	Type A 4	Type A 5	Type A 6	Type A 7				

This screen allows you to setup Type A (2-wire) sensors connected to the console. You access each of your site's Type A sensor setups by touching the desired button at the bottom of the screen.

### Configured

Allowable selections: Enabled, Disabled  
Default: Disabled

### Address

Allowable selections: Choose from drop-down list of available Type A sensors, Not Assigned  
Default: Not Assigned

### Label

Allowable selections: Up to 20 alphanumeric characters  
Default: Blank

### Model

Select the sensor's model from the drop down list.

Allowable selections: Discrim. Interstitial, Ultra 2  
Default: Discriminating Interstitial

**Category**

Select the sensor's category (location) from the drop down list.

Allowable selections: Other Sensors, Annular Space, Dispenser Pan, Monitor Well, STP Sump, Containment Sump

Default: Other Sensors

## Device Setup - Type B Sensor

07/10/2008 11:27 AM		All Functions Normal					
Device Setup - Type B Sensor (3-Wire CL)							Sensor 1 :
Liquid Sensor	Type A Sensor (2-Wire CL)	Type B Sensor (3-Wire CL)					
Configured	Disabled						
Address	Not Assigned						
Label							
Address [2]							
Model	Ultra/Z-1						
Type B 1	Type B 2	Type B 3	Type B 4	Type B 5	Type B 6	Type B 7	

This screen allows you to setup Type B (3-wire) sensors connected to the console. You access each of your site's Type B sensor setups by touching the desired button at the bottom of the screen.

### Configured

Allowable selections: Enabled, Disabled  
Default: Disabled

### Address

Allowable selections: Choose from drop-down list of available Type B sensors, Not Assigned  
Default: Not Assigned

### Label

Allowable selections: Up to 20 alphanumeric characters  
Default: Blank

### Address [2]

Allowable selections: Read-only - next sequential address

## **TLS-450 Setup and Operation Screens Manual**

### **Model**

Select the sensor's model from the drop down list.

Allowable selections: Ultra/Z-1 (4Site Pan/Sump - Standard), Ultra/Z-1 HV (4Site Pan/Sump - High Vapor)  
Default: Ultra/Z-1

### **Category**

Select the sensor's category (location) from the drop down list.

Allowable selections: Other Sensors, Annular Space, Dispenser Pan, Monitor Well, STP Sump,  
Containment Sump  
Default: Other Sensors

## Device Setup - Mag Sensor

This screen allows you to setup Mag Sensors connected to the console. The Mag Sensor defines the fields that are available for editing, the ranges for each field, and the default value. The Mag Sensor cannot be setup until its device address has been assigned.

If your console has the internal printer, touch the Print button to printout the Mag Sensor Setup. On the printout, look at the factory preset Alarm Delay and Alarm Threshold settings for the Mag Sensor (see Mag Sensor setup printout example below):

MAG SENSOR ALM DELAY						
SENSOR	LABEL		DELAY			
1	(label)		48			
MAG SENSOR ALARM THRESHOLD						
MS 1:(label)						
ID	VALUE	THRESHOLD	ALARM	PROGRAMMBLE	UPGRADE	
1	FUEL HT	> 1.6	FUEL ALARM	NO	NO	
3	WATER HT	> 3.0	WATER ALARM	NO	NO	
4	WATER HT	> 1.7	WATER WARNING	NO	YES	

Printout example notes:

1. The '<' (drop below) or '>' (rise above) symbols in the printout example indicate the point (threshold) at which the Alarm/Warning will be triggered.
2. The Programmable column indicates if the Alarm/Warning threshold is or is not programmable.
3. The Upgrade column indicates if the Alarm/Warning's Alarm Delay feature (see field below) is activated.
4. The Water Warning has an programmable Alarm Delay that was set to 48 hours.

**Configured**

Allowable selections: Enabled, Disabled

Default: Disabled

**Address**

Allowable selections: Choose from drop-down list of available Mag sensors, Not Assigned

Default: Not Assigned

**Label**

Allowable selections: Up to 20 alphanumeric characters

Default: Blank

**Serial Number**

This is a read-only entry of the selected Mag Sensor's serial number.

**Alarm Delay**

This display appears if the alarm delay has been factory set to programmable. This is the time in hours following the triggering of uncleared warnings, before they are upgraded to alarms. Also, this upgrade only applies to Mag Sensor warnings that have been factory set to upgrade.

Allowable selections: 0-9999 Hours

Default: Assigned by sensor

**Water Warning**

This display appears only if the Water Warning has been factory set to programmable. This is the height in inches (or mm if metric units selected) at which the Water Warning will activate.

Allowable selections: 1.7 - 22 in. (44 - 558mm)

Default: 0

**Water Alarm**

This display appears only if the Water Alarm has been factory set to programmable. This is the height in inches (or mm if metric units selected) at which the Water Alarm will activate. Refer to your Smart Sensor Setup printout's Min/Max Thresholds for the permissible range within which to select this value.

Allowable selections: 1.7 - 22 in. (44 - 558mm)

Default: 0

## Device Setup - Groundwater Sensor

07/10/2008 11:33 AM		All Functions Normal					
Device Setup - Ground Water Sensor							Sensor 1 :
Type B Sensor (3-Wire CL)	MAG Sensor	Ground Water Sensor	Vapor Sensor				
Configured	Disabled						
Address	Not Assigned						
Label	<input type="text"/>						
Address [2]	<input type="text"/>						
Category	Other						

This screen allows you to setup Groundwater sensors connected to the console. You access each of your site's Groundwater sensor setups by touching the desired button at the bottom of the screen.

### Configured

Allowable selections: Enabled, Disabled. Default: Disabled

### Address

Allowable selections: Choose from drop-down list of available Groundwater sensors. Default: Not Assigned

### Label

Allowable selections: Up to 20 alphanumeric characters. Default: Blank

### Address [2]

Allowable selections: Read-only - next sequential address

### Category

Select the sensor's category (location) from the drop down list. Allowable selections: Other Sensors, Annular Space, Dispenser Pan, Monitor Well, STP Sump, Containment Sump. Default: Other Sensors



## Device Setup - Vapor Sensor

07/10/2008 11:34 AM		All Functions Normal							
Device Setup - Vapor Sensor								Sensor 1 :	
Type B Sensor (3-Wire CL)	MAG Sensor	Ground Water Sensor	Vapor Sensor						
Configured	Disabled								
Address	Not Assigned								
Label									
Address [2]									
Threshold									
Vapor 1	Vapor 2	Vapor 3	Vapor 4	Vapor 5	Vapor 6	Vapor 7			

This screen allows you to setup Vapor sensors connected to the console. You access each of your site's Vapor sensor setups by touching the desired button at the bottom of the screen.

### Configured

Allowable selections: Enabled, Disabled  
Default: Disabled

### Address

Allowable selections: Choose from drop-down list of available Vapor sensors, Not Assigned  
Default: Not Assigned

### Label

Allowable selections: Up to 20 alphanumeric characters  
Default: Blank

### Address [2]

Allowable selections: Read-only - next sequential address





## **Threshold**

The Threshold field lets you enter vapor levels to identify a leak or serious spillover and to trigger the vapor alarm. Thresholds are in ohms and must be calculated for each vapor sensor according to the procedure described below. Thresholds may be set to account for existing vapor levels as long as these vapors do not exceed the limits explained below.

### **BEFORE YOU BEGIN**



**IMPORTANT!** A vapor sensor must be operated only in wells where preliminary testing has determined that the soil is not already contaminated beyond acceptable limits (as defined by applicable regulations) or that contaminated soil has been remediated and is now clean. A vapor sensor should not be operated in wells where preliminary testing indicates that the initial vapor sensor resistance exceeds 25k ohms. Vapor sensors must have been installed in their wells at least 24 hours prior to calculating and entering vapor alarm thresholds.

 <b>WARNING!</b>	
	<b>This system contains electrical voltages that can be lethal.</b>
	<b>Electrical shock resulting in serious injury or death could result if incorrect service procedures are used. When you perform the following procedure:</b>
	<b>1. Read all instructions carefully 2. Turn Off power to the console.</b>

### **DETERMINING THRESHOLD**

1. Turn Off all AC power to the console.
2. Open the right-hand door of the console and determine the USM module to which the vapor sensor is connected. The vapor sensor has a 3-wire cable with black "+", green "-", and white "+" colored wires. Every 3-wire sensor should connect to adjacent terminals on the USM module.
3. Find the module connections of the Vapor Sensor which is to be measured for a vapor threshold value.
4. Measure the resistance across the "+" (black wire) and "-" (green wire) terminals using an ohmmeter.
5. Multiply the measured resistance by 4 to determine the vapor threshold value that you should enter.
6. Enter the calculated vapor threshold value.

Allowable selections: 1000 - 100,000 ohms

Default: 0

### **Category**

Select the sensor's category (location) from the drop down list.

Allowable selections: Other Sensors, Annular Space, Dispenser Pan, Monitor Well, STP Sump, Containment Sump

Default: Other Sensors

## Device Setup - Line Pressure Sensor

07/23/2008 06:11 PM		All Functions Normal		?		📄		↶		🏠		↷	
Device Setup - Line Pressure Sensor										Sensor 1 :		🔍	
MAG Sensor		Ground Water Sensor		Vapor Sensor		Line Pressure Sensor		◀		▶			
Configured		Enabled										▼	
Address		B1.S1.7										▼	
Label												🔍	
Serial Number		547817027											
Press 1		Press 2		Press 3		Press 4		Press 5		Press 6		Press 7	
												▶	
												▲	
												▼	

This screen allows you to setup Pressurized Line Leak Detection (PLLD) pressure sensors that have been connected to the console.

### Configured

Allowable selections: Enabled, Disabled  
Default: Disabled

### Address

Allowable selections: Choose from drop-down list of available Line Pressure sensors, Not Assigned  
Default: Not Assigned

### Label

Allowable selections: Up to 20 alphanumeric characters  
Default: Blank

### Serial Number

This is a read-only value.

## Device Setup - LV/MDIM

03/03/2010 02:03 PM		T 1: SETUP DATA WARNING								
Device Setup - LV/MDIM								LV/MDIM 1 :		
Ground Water Sensor		Vapor Sensor		Line Pressure Sensor		LV/MDIM				
Configured	Disabled									
Address	Not Assigned									
Label										
Unit Conversion	US									
Pulse Conversion	1/2									
LV/MDIM 1	LV/MDIM 2	LV/MDIM 3	LV/MDIM 4	LV/MDIM 5	LV/MDIM 6	LV/MDIM 7				

This screen allows you to setup Low Voltage Mechanical Dispenser Interface Modules (LVDIMs) and Mechanical Dispenser Interface Modules (MDIMs) installed in the console. You access each of your site's LVDIM or MDIM setups by touching the desired button at the bottom of the screen.

### Configured

Allowable selections: Enabled, Disabled  
Default: Disabled

### Address

Allowable selections: Choose from drop-down list of available addresses, Not Assigned  
Default: Not Assigned

### Label

Allowable selections: Up to 20 alphanumeric characters  
Default: Blank

### Unit Conversion

Allowable selections: U.S., Metric or Imperial  
Default: U.S.

**Pulse Conversion**

Allowable selections: 1/2, 2.5, 10, 25, 100, 250, 500, 1000 or Custom

Default: 1/2

**Custom**

This field is only available if Custom is selected for Pulse Conversion above. Enter a custom pulse conversion using the numeric keypad to the right of the window.

## Tank Setup - General

The Tank Setup - General screen lets you enter parameters for individual tanks.

### Configured

To configure a tank the following must be true:

1. A probe must be assigned to the tank
2. The probe must have a valid address
3. The tank must have a viable chart as follows;
  - All charts must include diameter and full volume,
  - A 4 point chart must have the diameter and 3 valid tank chart volumes,
  - A 20 point chart must have the diameter and 19 valid tank chart volumes

Allowable selections: Enabled or Disabled

Default: Disabled

**Tank Label**

This value is a description field for the tank. Usually it is based on the name of the product in the tank. It should be unique for each tank. It is not the description value associated with the product code assigned to the tank. The system will not require that a label be assigned to configure the tank, but a data setup warning will occur if one is not assigned.

Allowable entry: 20 characters maximum - should be unique across tanks.  
Default: Blank

**Product Code**

Enter the alphanumeric code used by a point-of-sale terminal or other external device to identify the product for inventory control purposes.

Allowable entry: 1 character (all ASCII characters in the set 20h to 7Eh)  
Default: A single character based on tank number, e.g., 1 to 9 for tank numbers 1 to 9 or A to W for tank numbers 10 to 32.

**Probe**

Select the identifier of the probe installed in this tank from the drop down list. A probe assignment to a tank is one to one (i.e. Probe 1 assigned to Tank 1, Probe 2 assigned to Tank 2, etc.).

Allowable entry: Select this probe's identifier from the drop down list.  
Default: 'Not Assigned'

**Probe Offset**

This offset is intended for installations in which the probe is not resting on the bottom of the tank. The value you enter (the distance off bottom) is continually added to the product height, but only to the water height when the water float exceeds a minimum level.

Allowable selections: -144 to +144 in. (-3657.6 to +3657.6 mm)  
Default: 0

**Full Volume (Capacity)**

Enter the full volume of the tank (at 100% height).

Allowable entry: 0 to 264,172 gallons (0 to 999, 999 litres)  
Default: 0

**Diameter**

Enter the inside diameter of the selected tank (for a linear tank, enter the inside tank height in place of the tank's inside diameter). You can find this dimension on the Tank Chart.

Allowable entry: 0 to 390.0 inches (0 to 9906.0mm)  
Default: 0

**Tank Tilt**

Enter the tank tilt (if any) as calculated following instructions in the TLS-4XX Site Prep manual. If the probe is installed in the center of the tank, enter 0.00 U.S. units or 0.00 Metric.

Allowable entry: -20.00 to +20.00 inches (-508.0 to +508.0mm)  
Default: 0.00

**Thermal Coefficient**

To ensure proper leak test performance, you must enter the Coefficient of Thermal Expansion for the fuel in the tank. The system requires these values to establish proper temperature compensation factors during a leak test and for use in calculating temperature compensated volume. If you know your product's thermal coefficient enter that value. Otherwise, refer to the list below of typical thermal coefficients for various fuels and liquids:

<b>Product</b>	<b>Thermal Coefficient (U.S. Units)</b>	<b>Thermal Coefficient (Metric Units)</b>
AdBlue or Urea	0.00045	0.00081
Alcohol	0.00063	0.00114
Aviation Gas	0.00075	0.00135
Diesel (fuel oil #2) [Derv]	0.00045	0.00081
< Derv> Biodiesel (B20)	0.00045	0.00081
< Derv> Biodiesel (B100)	0.00045	0.00081
Ethylene Glycol	0.00037	0.00067
Fuel Oil #4	0.00047	0.00085
Gasohol	0.00069	0.00125
Gear Oil, 90W	0.00047	0.00085
Hydraulic Oil	0.00047	0.00085
Jet Fuel	0.00047	0.00085
Kerosene (fuel oil #1) [Paraffin]	0.00050	0.00090
Liquefied Petroleum Gas (LPG) - Propane*	0.00160	0.00288
Liquefied Petroleum Gas (LPG) - Butane*	0.00109	0.00196
Leaded Gasoline	0.00070	0.00126
Motor Oil	0.00047	0.00085
Premium [4 Star]	0.00070	0.00126
Regular Unleaded Gasoline	0.00070	0.00126
Super Unleaded Gasoline	0.00070	0.00126
Low benzene unleaded petrol	0.00070	0.00126
Transmission Fluid	0.00047	0.00085
Turbine Oil	0.00047	0.00085
Water	0.00012	0.00022
Washer Fluid	0.00047	0.00085
Used Oil	0.00044	0.00079

\*Coefficient dependent on temperature, 15°C is nominal.

Allowable entry: 0.0 to 0.0016 gal/gal/ °F (0.0 to 0.00288 L/L/ °C)

Default: 0.0 (A value of 0.0 in this field means that TC volume is uncompensated volume, which is not compensated for temperature.)

**Meter Data Present**

When this feature is enabled, all meter data collected from the dispensers will be reported to the system. If dispenser data for this tank is being reported to the DIM then this parameter must be set to Enabled.

Allowable entry: Enabled, Disabled

Default: Enabled



**Pump Threshold (%)**

This feature is for line manifolded tanks and is only enabled when you have the Dispense Mode set to Manifolded:Sequential (See Setup/Pumps and Lines/Lines). When the tank's volume drops below the entered Pump Threshold percentage, pumping will switch over immediately to the next available tank in the line manifolded set. Pumping will continue from the current tank for another 10 seconds to avoid a disruption in dispensing during the switch over.

Allowable entry: 0.00 to 50.00% (of the tank's full volume)  
Default: 10.00%

**Stick Offset Fuel**

Allowable entry: -144 to +144 in (-3657.60 to 3657.60 mm)  
Default: 0

**Stick Offset Water**

Allowable entry: -144 to +144 in (-3657.60 to 3657.60 mm)  
Default: 0

**Delivery Delay**

Enter the number of minutes to wait after the Console determines that a Delivery is complete.

This delay period can prevent false Alarms and Warnings due to turbulence in the Tank caused by Deliveries.

Allowable entry: 1 to 99 minutes  
Default: 1

**Gross Test Fail**

The Gross Test Fail feature allows you to disable or enable an alarm that triggers when a 3.0 gph (11.3lph) leak test fails.

Allowable selections: Enabled or Disabled  
Default: Enabled

**Periodic Test Fail**

The Periodic Test Fail feature allows you to disable or enable an alarm that triggers if a 0.2 gph (0.76lph) leak test fails.

Allowable selections: Enabled or Disabled  
Default: Enabled

**Annual Test Fail**

The Annual Test Fail feature allows you to disable or enable an alarm that triggers when an 0.1 gph (0.38lph) leak test fails.

Allowable selections: Enabled or Disabled  
Default: Disabled

## Tank Setup - Limits

03/03/2010 12:25 PM		All Functions Normal		?		📦		📄		🏠		↶	
Tank Setup - Limits												Tank 1 :	
General		Limits		Environmental Tests		All Tanks		Product		Chart		▶	
Max. Volume (Label Vol.) [gal]		0											
High Product (% of max. vol.)		0											
Delivery Overfill (% of max. vol.)		0											
Delivery Limit (% of full vol.)		0											
Low Product [gal]		0											
												✓	
												✗	
												▲	
												▼	
Tank 1		Tank 2		Tank 3		Tank 4		Tank 5		Tank 6		Tank 7	

The Tank Setup - Limits screen sets Tank capacity values, along with Tank Alarm set points. These values apply to the currently selected Tank.

### Maximum Volume (Label Volume)

Maximum or Label Volume alarm warns when the level of fluid in the tank exceeds the volume you enter here. Set this value at a level higher than the High Product limit (See Figure 1).

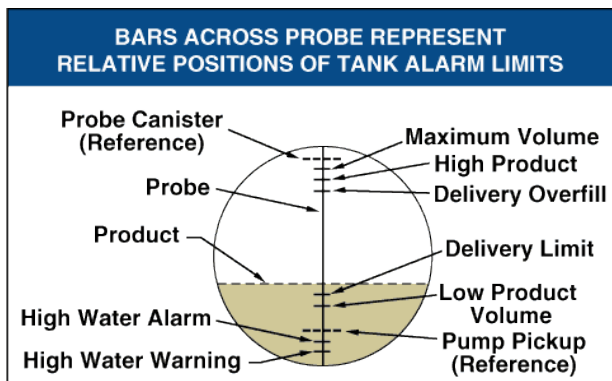

Figure 1.

Allowable entry: 0 to 264,172 gallons (0 to 999,999 litres). Default: 0

### **High Product (% of Maximum Volume)**

High Product Alarms occur when the Volume of fluid in the Tank exceeds the value you enter in this field.

Note: The High Product Alarm occurs whenever this Volume is exceeded, whether or not a Delivery is in progress. In U.S. installations this is especially useful in applications such as in Used Oil holding Tanks, where the rate of fill can be too gradual for the Console to recognize the increase as a Delivery, and possibly fail to activate the Delivery Overfill Limit Alarm.

Set this limit at a percentage that is between the Delivery Overfill Limit percentage and 95% (of the Tank's capacity) (See Figure 1).

In international installations this field is especially useful to warn of an impending overfill.

Set this limit to 98% if the Maximum Volume value is greater than 25,000 liters.

Set this limit to 96% if the Maximum Volume is less than 25,000 liters

### **Delivery Overfill (% of Maximum Volume)**

Delivery Overfill Alarms warn of a potential overfill during a Delivery. When the Volume reaches this value, the TLS-450 Console can activate an Overfill Alarm, and triggers a printout showing the Tank number, date, time, and product.

Set this percentage no greater than 90% of the Tank's capacity.

In international installations set this percentage to no greater than 99% of maximum (label) Volume (See Figure 1).

### **Delivery Limit (% of Full Volume)**

Delivery Limit warns when the Volume of Product in the tank drops to a level at which the operator will call for a delivery - i.e., minimum operating capacity. Set this percentage at a volume higher than that of the Low Product Volume field (See Figure 1).

### **Low Product**

Low Product Alarms warn when the Volume in the Tank drops to the level you enter in this field (See Figure 1).

In international installations, assuming no water is present in the Tank, this limit should be set no lower than:

- The Tank Volume at 250mm for Mag probe type 8473.
- The Tank Volume at 125mm for Mag probe type 8493.

These are the minimum Volumes that can be measured by each Probe type.

### **High Water Warning**

The High Water Warning acts as a Pre-Warning to the High Water Alarm. Set this value lower than the High Water Alarm (See Figure 1).

When Console detects that the Water level in the Tank is higher than the High Water Warning threshold value a Warning is posted. This behavior, however is affected by Deliveries as described below.

### **High Water Alarm**

Set this value at a level lower than the Pump Pickup value for the submersible Pump or suction Line (See Figure 1).

When Console detects that the Water level in the Tank is higher than the High Water Alarm value an Alarm is posted.

### **Water Alarm Filter Level**

The Console can be configured to provide water Alarm filtering during Deliveries. Filtering may be required because turbulence in a Tank during Delivery may cause false Water Alarms. On a per Tank basis, the user is able to select the level of filtering; Low, Medium or High. The default filter setting of Low will provide the quickest Alarm response time, but may be susceptible to false Alarms. In most applications the Water Alarm Filter Level setting of Low will not produce false water Alarms.

Adjustments to the Delivery fill tube may eliminate false water Alarms caused by Delivery turbulence. If Deliveries are causing an unacceptable number of false water Alarms increase the Water Alarm Filter Level to Medium. If the false water Alarms continue increase the filter level to High.

The three filter levels are explained in more detail below.

### **LOW FILTER**

When the Water Alarm Filter is set to Low Deliveries will not inhibit the posting of Water Alarms.

With the Low setting the Console detects that a Delivery is occurring when the fuel level in the Tank increases by 25 Gallons per Minute (GPM).

#### **Low Filter - High Water Alarm**

During a Delivery if the Console detects a High Water Alarm condition for three minutes it posts both an High Water Alarm and a High Water Warning immediately. The Delivery may still be in-progress when the Alarm and Warning occurs.

During a Delivery if the Water level is less than the High Water Alarm value the Console will clear the Alarm.

#### **Low Filter - High Water Warning**

During a Delivery if the Console detects a High Water Warning condition for three minutes, but does not detect a High Water Alarm condition during this time, the Console posts a High Water Warning after the Delivery is complete.

If the Delivery is in progress for more than 60 minutes, the High Water Warning posts after 63 minutes from the start of Delivery detection.

The same logic applies to the clearing of the High Water Warning.

#### **Low Filter - Maximum Height for the No-Delay Condition**

If the Water level is six inches or above the High Water Alarm value for three minutes, then the Console posts a High Water Alarm and High Water Warning, even when a Delivery is in progress.

## **MEDIUM FILTER**

The Medium Filter, like the Low Filter detects that a Delivery is occurring when the fuel level in the Tank increases by 25 Gallons per Minute (GPM).

### **Medium Filter - High Water Alarm**

During a Delivery if the Console detects a High Water Alarm condition for three minutes, it posts both a High Water Alarm and a High Water Warning after the Delivery completes.

If the Delivery is in progress for more than 30 minutes, the High Water Alarm posts after 33 minutes from the start of Delivery detection.

The same logic applies to the clearing of the High Water Alarm.

### **Medium Filter -High Water Warning**

During a Delivery if the Console detects a High Water Warning condition for three minutes the Console posts a High Water Warning after the Delivery completes.

If the Delivery is in progress for more than 60 minutes, the High Water Warning posts after 63 minutes from the start of Delivery detection.

The same logic applies to the clearing of the High Water Warning.

### **Medium Filter - Maximum Height for the No-Delay Condition**

Like the Low Filter, if the Water level is six inches or above the High Water Alarm value for three minutes, then the Console posts a High Water Alarm and High Water Warning, even when a Delivery is in progress.

## **HIGH FILTER**

The Water Alarm Filter setting of High follows the same behavior as the Medium level filter, however in this case the Console detects that a Delivery is occurring when the fuel level in the Tank increases by six Gallons per Minute (GPM).

### **High Filter - High Water Alarm**

During a Delivery if the Console detects a High Water Alarm condition for three minutes, the Console posts both a High Water Alarm and High Water Warning after the Delivery completes.

If the Delivery is in progress for more than 45 minutes, the High Water Alarm posts after 48 minutes from the start of Delivery detection.

The same logic applies to the clearing of the High Water Alarm.

### **High Filter - High Water Warning**

During a Delivery if the Console detects a High Water Warning condition for three minutes, but does not detect a High Water Alarm condition during this time, the Console posts a Warning after the Delivery completes.

If the Delivery is in progress for more than 60 minutes, the Console posts a High Water Warning after 63 minutes from the start of Delivery detection.

The same logic applies to the clearing of the High Water Warning.

**High Filter - Maximum Height for the No-Delay Condition**

If water level is 10 inches or more for three minutes, then the Console posts a High Water Alarm and High Water Warning, even when a Delivery is in progress.

**Leak Alarm Limit**

During a Leak Test the Leak Alarm Limit warns when the cumulative TC Product loss from a Tank reaches the Leak Alarm Limit. It identifies and warns of large losses of Product during a Leak Test.

To prevent false reports and Alarms from being triggered, do not set the limit value to identify losses of 0.2 gph (0.76 lph) or less during the test period. The Leak Alarm Limit should be set to identify losses of 1 gph (4 lph) or greater.

Consider both the leak rate you wish to identify and the length of the test when determining a value for Leak Alarm Limit. A value of 8 gallons (32 liters) will warn of:

- A 1 gph (4 lph) leak in 8 hours.
- A 2 gph (8 lph) leak in 4 hours.

Note: the system automatically interprets the limit you enter as a negative. It is not necessary to enter the minus (-) sign.

**Sudden Loss Limit**

Sudden Loss Limit (theft alarm limit loss) immediately warns of a sudden loss of fuel during a leak test. It is not based on TC Volume; it is intended to identify losses larger than the Leak Alarm Limit (See above). Typically, you should set this limit at 25 gallons (100 litres), or higher.

**Density Low Limit**

Density Low Alarms occur when the Fuel Density value falls below the value you enter in this field.

**Density High Limit**

Density High Alarms occur when the Fuel Density value rises above the value you enter in this field.

## Tank Setup - Environmental Tests

The screenshot displays the 'Tank Setup - Environmental Tests' interface. At the top, a status bar shows the date and time '03/03/2010 12:25 PM', a bell icon, and the text 'All Functions Normal'. Below this is a navigation bar with tabs for 'General', 'Limits', 'Environmental Tests', 'All Tanks', 'Product', and 'Chart'. The 'Environmental Tests' tab is active. A dropdown menu for 'Tank Test Method' is set to 'Disabled'. At the bottom, there are buttons for 'Tank 1' through 'Tank 7' and navigation arrows.

This screen provides a choice of disabling a tank test (default), or enabling SLD or CSLD tests for a selected tank. Once a Tank Test Method has been chosen, the corresponding setup parameters for either SLD or CSLD will be displayed in the data view area. Choosing a test enables this test and provides the settings by which the test will be conducted. However, enabling a test is not the same as starting the test, which may be started at a later point.

### Tank Test Method

SLD (Static Leak Detection) tests - A single test that runs on demand, at a programmed time, or by pump sense signal. Results are stored for leak test reports.

CSLD (Continuous Statistical Leak Detection) tests - leak tests are run continuously during idle tank times and information is stored for leak test reports.

Allowable selections: Disabled, SLD, CSLD  
 Default: Disabled

--- If Tank Test Method Selected is SLD ---

03/03/2010 03:35 PM		F 1: SETUP DATA WARNING					
Tank Setup - Environmental Tests							Tank 1 : regular
General	Limits	* Environmental Tests	All Tanks	Product	Chart		
Tank Test Method *	SLD						
Leak Test Rate	0.2 gph LEAK TEST						
Periodic Test Type	Standard						
Test Frequency	03/03/2010, 03:34 PM						
Gross Test Auto-Confirm	Disabled						
Tank 1	Tank 2	Tank 3	Tank 4	Tank 5	Tank 6	Tank 7	

**Leak Test Rate**

Allowable selections: 0.2 gph (0.76 lph), 0.1 gph (0.38 lph)  
 Default: 0.2 gph (0.76 lph)

**Periodic Test Type**

Two periodic SLD test types are available:

1. 'Standard' - performs a 2-hour periodic leak test.
2. 'Quick' - performs a 0.2 gph (0.76 lph) test in one hour. This selection requires a wait period of 5 hours after a delivery before starting the SLD test.

Allowable selections: Standard, Quick  
 Default: Standard



**Test Frequency**

Touch the Calendar button  to select the desired frequency for SLD tests as described below:

Field	Range, Min, Max	Default	Visible If:
Period	On Date, Annually by Date, Annually by Day of Month, Monthly by Day of Week, Monthly by Day of Month, Weekly, Daily	On Date	Always
	Auto		Tank's pump mode is set to 'Pump Sense'
Set Date	Month: 1-12, Day: 1-31, Year: 1970 - 2038	Current Date	If Period choice is On Date:
Month	January - December	January	If Period choice is Annually by Day of Week, Annually by Day of Month
Weekday	Sunday - Saturday	Sunday	If Period choice is Annually by Day of Week, Monthly by Day of Week, Weekly
Occurrence	1st, 2nd, 3rd, 4th, Last	1st	If Period choice is Annually by Day of Week, Monthly by Day of Week
Day of Month	1 - 31	1	If Period choice is Annually by Day of Month, Monthly by Day of Month
Time of Day	Time in Hours and Minutes, 12 Hr. sensitive	Current time + 2 minutes	If Period choice is If Period choice is On Date, Annually by Day of Week, Annually by Day of Month, Monthly by Day of Week, Monthly by Day of Month, Weekly, Daily

**Gross Test Auto-Confirm**

Available when SLD Test Frequency is set to Auto. When enabled, this feature may reduce false alarms. Two tests in a row must fail before a Gross Leak Test Fail alarm is posted.

Allowable selections: Enabled, Disabled  
 Default: Disabled

**Duration**

Allowable selections: 2 - 24 Hours  
 Default: 2

**Leak Min. Periodic (% full volume)**

This value tells the system the minimum tank volume required to record a passed periodic test. The value reflects federal, state, and local requirements.  
 Allowable selections: 0 - 100%. Default: 0

**Leak Min. Annual (% full volume)**

This value tells the system the minimum tank volume required to record a passed annual test. The value reflects federal, state, and local requirements.

Allowable selections: 0 - 100%  
Default: 0

**Early Stop**

When enabled this feature will prevent an In-Tank Leak Test from starting under the following conditions:

1. Fuel level is less than Leak Min. Periodic (0.2 gph test rate) or Leak Min. Annual (0.1 gph test rate).
2. It is less than 8 hours from a delivery if Standard test or 5 hours from delivery for Quick test.
3. The product temperature is less than 0°F (-17.6°C) or more than +100°F (+37.4°C).
4. The fuel level is too low.

Allowable selections: Enabled, Disabled  
Default: Disabled

**Tank Test Notify**

When "On" this feature triggers a warning allowing the operator to set a relay to shutdown the submersible pump.

Allowable selections: On, Off  
Default: Off

**Tank Test Siphon Break**

When "On" this feature allows the operator to perform in-tank leak tests on siphon manifolded tanks (a siphon break valve must be installed for this selection).

Allowable selections: On, Off  
Default: Off

--- If Tank Test Method Selected is CSLD ---

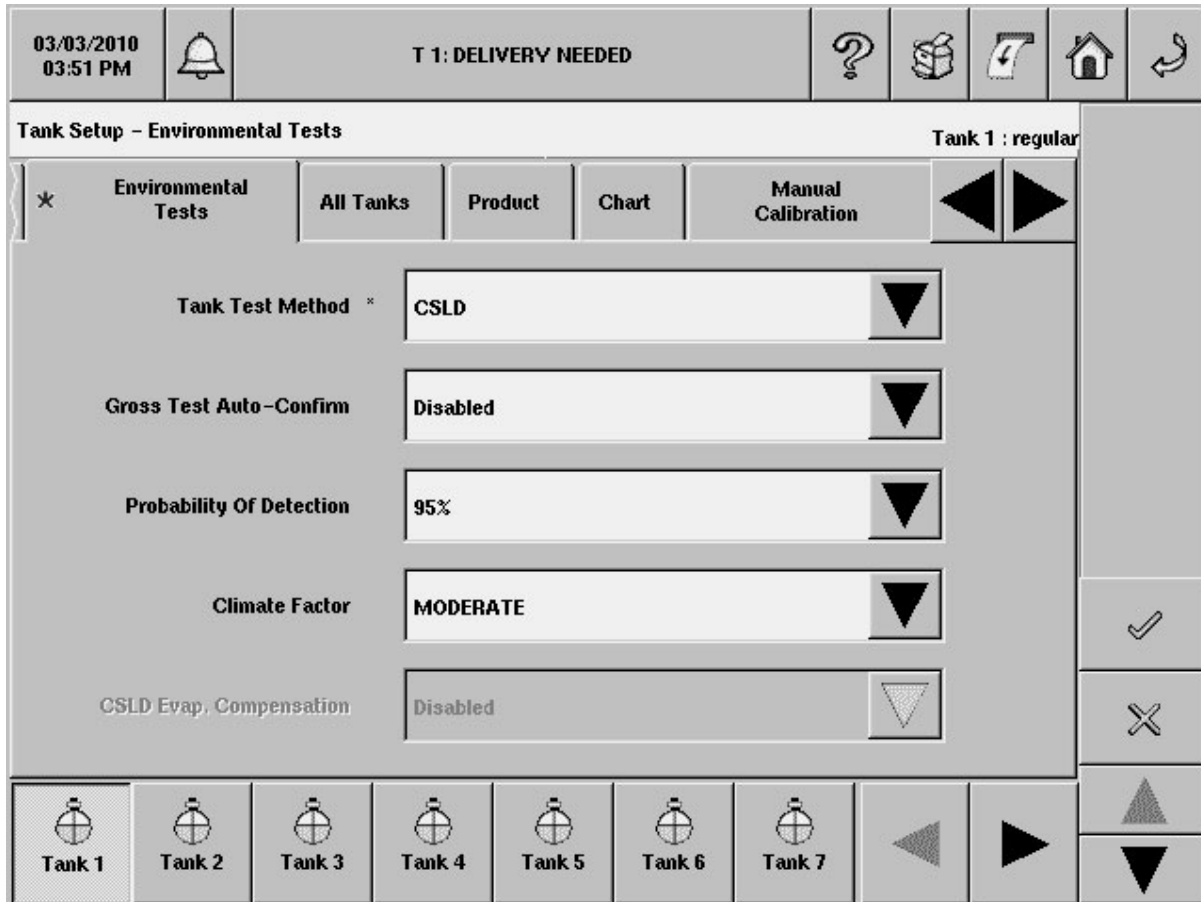

**Gross Test Auto-Confirm**

When enabled, this feature may reduce false alarms. Two tests in a row must fail before a Gross Leak Test Fail alarm is posted.

Allowable selections: Enabled, Disabled  
 Default: Disabled

**Probability of Detection**

You can set the Probability of Detection to 95% or 99%. If "Custom" appears in this field, a special value has been entered remotely. Do not change the selection from Custom.

Allowable selections: 95%, 99% or Custom  
 Default: 95%

**Climate Factor**

If Climate Factor is set to Moderate, the two fields "Stage II Vapor Recovery" and "Tank CSLD Evap. Compensation" will be disabled. Extreme should only be used on individual tanks which have exhibited evidence of consistent, extreme vapor loss due to fuel evaporation, and which interferes with normal CSLD leak detection monitoring causing false leak alarms.

Allowable selections: Moderate, Extreme. Default: Moderate

**CSLD Evap. Compensation**

Evaporation Compensation should only be enabled on individual tanks which have exhibited evidence of consistent, extreme vapor loss due to fuel evaporation, which interferes with normal CSLD leak detection monitoring by causing false leak alarms.

Note: This selection field will be enabled only if Climate Factor is set to Extreme.

Allowable selections: Enabled, Disabled

Default: Disabled

**Stage II Vapor Recovery**

This selection will be enabled only if Climate Factor is set to Extreme and CSLD Evap. Compensation is enabled.

Allowable selections: Enabled, Disabled

Default: Disabled

## Tank Setup - All Tanks

03/03/2010 12:26 PM		All Functions Normal		?		📦		📄		🏠		↶	
Tank Setup - All Tanks										All Tanks			
General		Limits		Environmental Tests		All Tanks		Product		Chart		▶	
User Ullage		Disabled										▼	
User Ullage %		90										🔍	
Print TC Volumes		Disabled										▼	
TC Reference [°F]		60.0										🔧	
CSLD Evap. Reid Vap. Pressure Chart		JAN 0.0										▼	
Periodic Test Needed Warnings		Disabled										▼	
										✓			
										✗			
										▲			
										▼			

This screen contains parameters that apply across all tanks in the system.

### User Ullage

Ullage is the volume (space) in the tank as product is dispensed. This field lets you enable display of the User Ullage volume as well as enable the User Ullage% field. When this field is disabled, User Ullage will not be displayed by the GUI.

Allowable Selection: Enabled/Disabled

Default: Disabled

### User Ullage%

Select the percent of ullage volume to display.

Allowable Selection: 90 - 100%

Default: 90%

### Print TC Volumes

Print TC (Temperature compensated) Volumes only applies to end-user reports (Inventory, Delivery, etc.).

Allowable Selection: Enabled/Disabled. Default: Disabled

### **TC Reference**

This field lets you enter the temperature compensation (TC) Reference temperature for all volume calculations. This temperature is determined by your location. In the U.S., the reference temperature used to calculate TC volume is normally 60°F. In other countries, this value may differ. Canada, for example, uses 15°C.

**NOTES:**

1. All leak calculations are based on the reference temperature you enter.
2. If BIR is being used and the meters reporting the sales are temperature compensated, the value you enter must match the meters' reference temperature value. Also, in BIR setup, Temperature Compensation must be set to Enabled.

Allowable Selection: -40 to 120°F or -40 to 48.8°C (depending on System Units selection)  
Default: 60°F or 15.5°C

### **CSLD Evap. Reid Vap. Pressure Chart**

This field appears only when the Tank Test Method selection is set to CSLD, the Climate Factor selection is set to Extreme and the CSLD Evap. Compensation selection is set to Enabled in the Tank Setup - Environmental Tests tab screen.

You will need to enter a Reid Vapor Pressure (RVP) value for at least 1 month of the year. The RVP monthly values for your geographical area can be obtained from your local Petroleum Distributor.

Allowable range of valid RVP entries: 0 to 15.  
Default: 00.0.

### **Periodic Test Needed Warning**

The console monitors the amount of time since the last passed 0.2 gph (0.76 lph) tank test. By enabling the Periodic Test Warning, you can have the system provide a warning when a tank test has not been passed, or conducted, in a specified number of days (0 to 30), and activate an alarm if a test has not been passed after a warning, or a specified number of days.

Allowable Selection: Enabled/Disabled  
Default: Disabled

### **Days Before Periodic Warning**

Allowable Selection: 0 - 30  
Default: 25 days

### **Days Before Periodic Alarm**

Allowable Selection: 0 - 30  
Default: 30 days

### **Annual Test Needed Warning**

The console monitors the amount of time since the last passed 0.1 gph (0.38 lph) tank test. By enabling Annual Test Warning, you can have the system provide a warning when a 0.1 gph (0.38 lph) tank test has not been passed or conducted in a specified number of days (0 - 365) and activate an alarm if a test has not been passed after a warning, or a specified number of days.

Allowable Selection: Enabled/Disabled  
Default: Disabled

**Days Before Annual Warning**

Allowable Selection: 0 - 365

Default: 355 days

**Days Before Annual Alarm**

Allowable Selection: 0 - 365

Default: 365 days

**TC Density**

Allowable Selection: Enabled/Disabled

Default: Disabled

**Density Method**

Allowable Selection: GOST, API

Default: API

## Tank Setup - Product

03/03/2010 12:26 PM				All Functions Normal											
Tank Setup - Product														Edit	
General		Limits		Environmental Tests		All Tanks		Product		Chart					
Product#		Product Label												Set Tanks Product	
		1 Not Assigned												View All Products	
		2 Not Assigned													
		3 Not Assigned													
		4 Not Assigned													
		5 Not Assigned													
		6 Not Assigned													
		7 Not Assigned													
		8 Not Assigned													
		9 Not Assigned													
		10 Not Assigned													
		11 Not Assigned													
		12 Not Assigned													
		13 Not Assigned													
		14 Not Assigned													
		15 Not Assigned													
		16 Not Assigned													

This screen lets you view, edit product labels for all tanks in the system and determine the content of Reconciliation reports.

### Report Column Descriptions

#### Product #

This column contains the product number.

#### Product Label

This column contains the assigned label for the product number. The default is 'Not Assigned'.

### Control Buttons (Right Side of Screen)

#### Edit

Touch (highlight) a product number in the data view area and then touch this button to display the **Edit Product Label** dialog box:



**Product #**



Read-only field - displays the product number.

**Product Label**

Touch the keypad to the right of this field to change the product label (This label will appear on the right side of the Reconciliation report title bar).

Allowable selection: Alpha-Numeric label up to 20 characters max.

Default: Not Assigned or Current product label.

Touch the  button to accept edited values or  button to abort the change and close the **Edit Product Label** dialog box.

**Set Tanks Product**

Touch this button to open the 'Tank Setup - Product -Tank(s) Product Mapping' screen. This screen allows you to group single and manifolded tanks into product-summarized Reconciliation reports.

**View All Products**

Touch the 'View All Products' button to display the Tank Setup -View All Products screen. This screen displays all Product/Tank assignments.

## Tank Setup - Product Mapping

03/03/2010 02:11 PM		T 1: SETUP DATA WARNING					
Tank Setup - Product - Tank(s) Product Mapping							Edit
Tank(s) Product Mapping		View All Products					
Tank(s)	Product						
T 1	F 1						
T 2	Not Assigned						
T 3	Not Assigned						
T 4	Not Assigned						
T 5	Not Assigned						
T 6	Not Assigned						
T 7	Not Assigned						
T 8	Not Assigned						
T 9	Not Assigned						
T 10	Not Assigned						
T 11	Not Assigned						
T 12	Not Assigned						
T 13	Not Assigned						
T 14	Not Assigned						
T 15	Not Assigned						
T 16	Not Assigned						

This screen allows you to view and/or assign a product to a tank. These assignments group single and manifolded tanks into product-summarized Reconciliation reports.

### Report Column Descriptions

#### Tank(s)

This column contains the Tank number.

#### Product

This column contains the product assigned to the tank. The default is 'Not Assigned'.

### Control Buttons (Right Side of Screen)

#### Edit



Touch (highlight) a tank's row in the data view area and then touch this button to display the **Edit Tank(s) Product** dialog box:

**Tank(s)**









Read-only field displays the selected tank (e.g. T1).

**Product**

If the selected tank has a product assigned, it will appear in this field (e.g., F1: Regular Unleaded). If the selected tank has no product assigned, Not Assigned will appear in this field. Touch the down arrow to the right of this field to edit or assign a product to the selected tank.

Touch the  button to accept edited values or  button to abort the change and close the **Edit Tank(s) Product** dialog box.

## Tank Setup - View All Products

03/03/2010 02:12 PM		T 1: SETUP DATA WARNING					
Tank Setup - Product - View All Products							
Tank(s) Product Mapping		View All Products					
Product	Label	Tank(s)					
1	T 1: regular						
							
							

Touch the 'View All Products' button to display the Tank Setup -View All Products screen. This screen displays all Product/Tank assignments.

## Tank Setup - Chart

03/03/2010 12:29 PM		All Functions Normal			?		📦		↶		🏠		↷				
Tank Setup - Chart											Tank 1 : regular						
General		Limits		Environmental Tests		All Tanks		Product		Chart		◀		▶			
Tank Profile		One Point										▼					
Full Volume 92.0 in		10000.0															
End Shape		0.0										🔍					
														✓			
														✗			
														▲			
														▼			
Tank 1		Tank 2		Tank 3		Tank 4		Tank 5		Tank 6		Tank 7		▶		▶	

This screen allows you to manually setup a tank chart using one of four tank profiles: 1 point, 4 point, 20 point or linear. You must enter the diameter and full volume before selecting a tank chart (See [Tank Setup - General Tab](#)).

### Tank Profile

**Note:** For the currently selected Tank, if either Full Volume or Tank Diameter are set to 0, this field will be disabled.

- 1 point - This method requires only the 100% (full) volume to profile the tank. This selection is used for horizontally installed, flat-ended cylindrical tanks, and should be selected when AccuChart II is available for this type tank.
- 4 Points - This method requires 4 volumes to profile the tank. The requested volumes are at percentages of height (e.g., the 75% volume of a 96" diameter tank = the volume at a height which is 75% of 96" or 72"). This selection can be used for all rounded- and dished-end tanks, and should be selected when AccuChart II is available for these type tanks.
- 20 points - This method requires 20 volumes to profile the tank. The requested volumes are at percentages of height (e.g., the 5% volume of a 96" diameter tank = the volume at a height which

## TLS-450 Setup and Operation Screens Manual

is 5% of 96" or 4.8"). This selection can be used for all rounded- and dished-end tanks.

- Linear - This method requires only the 100% (full) volume to profile the tank. When using the linear tank profile you must enter the inside height of the tank in place of the inside diameter of the tank in Tank Diameter setup (see above). This profile can be used for flat-ended cylindrical tanks standing on end and for rectangular tanks.

Allowable selections: 1 point chart, 4 point chart, 20 point chart, or linear chart

Default: 1 point chart

### Full Volume (at full height) in or mm

This value is read only and displays the total capacity and the diameter (full height) of the tank (ref. [Tank Setup - General](#) Tab).

Display range: Volume = 0 to 264,172 gals (0 to 999,999 litres), Diameter = 0 to 390.0 inches (0 to 9906.00 mm)

### Enter volumes at read-only heights

Height values for the points within the chart are automatically displayed and are read only. These height values are automatically calculated by dividing the tank's entered diameter into 'n' equal portions, where 'n' is the number of points you selected for the chart.

Enter the volume (at height) for each of the displayed height/volume pairs as calculated from the manufacturer's tank chart. The volume entered at any height should not exceed the volume at a greater height.

**Note: For the currently selected Tank, if either Full Volume or Tank Diameter has been set to 0, this field will be disabled.**

Allowable selections: 0 to Full Volume gals (0 to Full Volume litres)

### End Shape

This field only appears when the 1 point chart is selected for 'Tank Profile' above.

Allowable selections: 0 to 1.0 in 0.1 increments (0.3 is the recommended end value for dished-end tanks)

Default: 0

## Tank Setup - Manual Calibration

03/03/2010 12:29 PM		All Functions Normal						
Tank Setup - Manual Calibration							Tank 1 : regular	Tank Busy
Environmental Tests	All Tanks	Product	Chart	Manual Calibration			Add Point	
Point	Height	Volume Change	Volume	Status			Edit Point	
							Delete Point	
							Make Chart	
							Setup	
Tank 1	Tank 2	Tank 3	Tank 4	Tank 5	Tank 6	Tank 7		

This screen allows you to (jump to the paragraph by touching the link):

- [View an existing manually calibrated chart,](#)
- [Add a new manually calibrated chart,](#) or
- [Update an existing manually calibrated chart](#) (Non-active charts only)

You cannot manually calibrate a tank by any method until you enter a Diameter and Capacity for that tank in the [Tank Setup - General](#) tab screen.

NOTE: Source and volume entries are user programmable for new charts, and read-only for charts being updated or viewed.

### Viewing a Manually Calibrated Tank Chart

Open the Tank Setup - Manual Calibration screen for the selected tank. To view a manually calibrated chart for the selected tank, touch the **Setup** button on the right side of the screen to open the 'Tank Chart Setup' -dialog box. Touch the down arrow to the right of the **Function** field and select **View Chart**. Touch the down arrow to the right of the **Chart Name** field and select the name of the chart you would like to review.

The five columns of the Manual Calibration chart (Data Area) are described below.

- Point - This column lists the entered points of the chart .
- Height - This column lists the height of product in the tank at each chart point.
- Volume Change - This is read-only field showing the change in volume between chart points.
- Volume - This column lists the volume of product in the tank at each chart point.
- Status - This column display a check (OK) or an X (No) to denote validity of the chart point.

## **Adding a New Manually Calibrated Tank Chart**

---

NOTE: The active chart on each tank may not be edited, only viewed, and its name will not appear in the drop down.

You can manually calibrate a tank chart using one of three methods (touch the link to jump to the desired method):

- [User Entered: Entering height and volume values for each point from the tank manufacturer's tank chart](#)
- [Metered Drop: Entering metered volume received at each probe-read height point](#)
- [Metered Dispense: Entering metered volume dispensed at each probe-read height point](#)

### ENTRY METHOD RESTRICTIONS:

- For non-manifolded tanks, you can select one of the following source options: User Entered, Metered Drop or Metered Dispense.
- For line manifolded tanks, you can select one of the following source options: User Entered or Metered Drop.
- For siphon manifolded tanks, you can only select the following option: User Entered.

### **USER ENTERED METHOD**

The tank can be full or empty for this method.

1. Open the Tank Setup - Manual Calibration screen for the selected tank. To view a manually calibrated chart for the selected tank, touch the **Setup** button on the right side of the screen to open the 'Tank Chart Setup - Dialog Box'. Touch the down arrow to the right of the **Function** field and select **Create a New Chart**. Touch the down arrow to the right of the **Chart Name** field and enter the name of the new chart.
2. In the **Source** field select **User Entered**.
3. The **Volume Entry** field is grayed out for User Entered calibrations.
4. The **Max Step** field is read only and the volume displayed cannot be exceeded from one point to another.
5. Touch **OK** (check) to accept your entries and close the dialog.
6. Touch the **Add Point** button on the right of the screen to open the 'Add/Edit Tank Chart Point' dialog box.
7. The **Point** field will automatically start at 1 (and increment as you move to subsequent points). From the manufacturer's tank chart, enter Point 1's **Height** and **Volume** values. Touch the **OK** (check) button to enter the values for Point 1. Notice the Data Area of the screen displays your entry for Point 1.



8. Repeat the procedure in Step 6 until all points are entered.
9. After at least 10 points are entered, the **Make Chart** button on the right of the screen will become active. Touch this button to make the chart based on your entered points. Notice that the newly created chart will appear in the report area of the screen and its **Status** will be 'Ready'.
10. If this is the chart you want to use for the selected tank, touch the **Apply** button on the right side of the screen to make the chart active for the selected tank. The 'Confirm Apply' dialog box will display, touch the **Check (OK)** key to make this chart active for the selected tank. The *Warning Update Schedule is active and may override your choice of active chart* message indicates that the Update Schedule selection made in [Tank Setup - AccuChart II](#) tab screen may override this chart with an AccuChart II calibrated tank chart.

### **METERED DROP METHOD**

For this method the tank can be empty or already contain some product (the amount of which you will enter as the volume/height for point 1).

1. Open the Tank Setup - Manual Calibration screen for the selected tank. To view a manually calibrated chart for the selected tank, touch the **Setup** button on the right side of the screen to open the 'Tank Chart Setup - Dialog Box'. Touch the down arrow to the right of the **Function** field and select **Create a New Chart**. Touch the down arrow to the right of the **Chart Name** field and enter the name of the new chart.
2. In the **Source** field select **Metered Drop**.
3. In the **Volume Entry** field select **Total Volume** if the meter totalizes the metered dispenses, or select **Volume Change** if the meter displays actual volume for each dispense.
4. The **Max Step** field is read only and the volume displayed cannot be exceeded from one point to another.
5. Touch **OK (check)** to accept your entries and close the dialog.
6. Touch the **Add Point** button on the right of the screen to open the 'Add/Edit Tank Chart Point' dialog box. For Point 1, if the tank is empty, enter 0 in the **Volume** field and the 0 in the **Height** field. If the tank contains some product, enter the existing product's measured volume and measured height. Touch **OK (check)** to accept your entries for point 1 and close the dialog. Notice the Data Area of the screen displays your entry for Point 1.
7. Notice the **Tank Idle** indicator now displays **Start Delivery**. Begin dispensing product into an approved container/tank and notice the **Start Delivery** indicator displays **Tank Busy** while the fuel height is changing. Continue dispensing until the **Tank Busy** indicator displays **Stop Delivery** at which point stop dispensing. Record the volume dispensed for the next chart point.
8. When the **Stop Delivery** indicator changes to **Tank Idle**, touch the **Add Point** button on the right of the screen to open the 'Add/Edit Tank Chart Point' dialog box. Notice the point has incremented to 2 and the **Height** field displays the product's measured height at point 2. Enter the previously recorded volume dispensed in the **Volume** field. Note: if the tank was not empty at the start of this process, the first volume entry should include the existing fuel volume in the tank. Touch **OK (check)** to accept your entries for point 2 and close the dialog box. Notice the Data Area of the screen now displays your entry for Point 2.
9. Repeat Steps 6 and 7, entering points until the tank's volume is down to around the tank's previously entered 'Low Product Limit' (at least 10 points).

10. After at least 10 points are entered, the **Make Chart** button on the right of the screen will become active. Touch this button to make the chart based on your entered points. Notice that the newly created chart will appear in the report area of the screen and its **Status** will be 'Ready'.
11. If this is the chart you want to use for the selected tank, touch the **Apply** button on the right side of the screen to make the chart active for the selected tank. The 'Confirm Apply' dialog box will display, touch the **Check (OK)** key to make this chart active for the selected tank. The *Warning Update Schedule is active and may override your choice of active chart* message indicates that the Update Schedule selection made in [Tank Setup - AccuChart II](#) tab screen may override this chart with an AccuChart II calibrated tank chart.

### **METERED DISPENSE METHOD**

The tank should be full for this method.

1. Open the Tank Setup - Manual Calibration screen for the selected tank. To view a manually calibrated chart for the selected tank, touch the **Setup** button on the right side of the screen to open the 'Tank Chart Setup - Dialog Box'. Touch the down arrow to the right of the **Function** field and select **Create a New Chart**. Touch the down arrow to the right of the **Chart Name** field and enter the name of the new chart.
2. In the **Source** field select **Metered Dispense**.
3. In the **Volume Entry** field select **Total Volume** if the meter totalizes the metered dispenses, or select **Volume Change** if the meter displays actual volume for each dispense.
4. The **Max Step** field is read only and the volume displayed cannot be exceeded from one point to another.
5. Touch **OK (check)** to accept your entries and close the dialog.
6. Touch the **Add Point** button on the right of the screen to open the 'Add/Edit Tank Chart Point' dialog box. For Point 1, enter the tank's full capacity in the **Volume** field and the tank's height in the **Height** field. Touch **OK (check)** to accept your entries for point 1 and close the dialog. Notice the Data Area of the screen displays your entry for Point 1.
7. Notice the **Tank Idle** indicator now displays **Start Dispense**. Begin dispensing product into an approved container/tank and notice the **Start Dispense** indicator displays **Tank Busy** while the fuel height is changing. Continue dispensing until the **Tank Busy** indicator displays **Stop Dispense** at which point stop dispensing. Record the volume dispensed for the next chart point.
8. When the **Stop Dispense** indicator changes to **Tank Idle**, touch the **Add Point** button on the right of the screen to open the 'Add/Edit Tank Chart Point' dialog box. Notice the point has incremented to 2 and the **Height** field displays the product's measured height at point 2. Enter the previously recorded volume dispensed in the **Volume** field. Touch **OK (check)** to accept your entries for point 2 and close the dialog. Notice the Data Area of the screen now displays your entry for Point 2.
9. Repeat Steps 6 and 7, entering points until the tank's volume is down to around the tank's previously entered 'Low Product Limit' (at least 10 points).
10. After at least 10 points are entered, the **Make Chart** button on the right of the screen will become active. Touch this button to make the chart based on your entered points. Notice that the newly created chart will appear in the report area of the screen and its **Status** will be 'Ready'.
11. If this is the chart you want to use for the selected tank, touch the **Apply** button on the right side of the screen to make the chart active for the selected tank. The 'Confirm Apply' dialog box will display,

touch the **Check** (OK) key to make this chart active for the selected tank. The *Warning Update Schedule is active and may override your choice of active chart* message indicates that the Update Schedule selection made in [Tank Setup - AccuChart II](#) tab screen may override this chart with an AccuChart II calibrated tank chart.

### **Updating a Manually Calibrated Tank Chart**

Open the Tank Setup - Manual Calibration screen for the selected tank. To edit a manually calibrated chart for the selected tank, touch the **Setup** button on the right side of the screen to open the 'Tank Chart Setup - Dialog Box'. Touch the down arrow to the right of the **Function** field and select **Update a Non-Active Chart** (you cannot edit an active chart). Touch the down arrow to the right of the **Chart Name** field and select the name of the desired chart.

The chart points will display in the data view area of the screen. Touch the point you want to edit to select and the **Add Point** (to add the next point in the chart), **Edit Point** (to change this point's parameters) or **Delete Point** (to delete this point from the chart) buttons are activated on the right side of the screen.

When you have finished editing the chart, touch the **Make Chart** button to refresh the tank chart. When the status of the revised chart is 'Ready', touch the **Apply** button on the right side of the screen. The 'Confirm Apply' dialog box will display, touch the Check (OK) key to make this chart active for the selected tank. The *Warning Update Schedule is active and may override your choice of active chart* message indicates that the Update Schedule selection made in [Tank Setup - AccuChart II](#) tab screen may override this chart with an AccuChart II calibrated tank chart.

### **Control Buttons (right of screen)**

---

#### **Tank Busy**

This is not a button but an indicator that displays tank states during metered dispense and metered drop calibrations. Possible messages include:

- **Tank Busy** - Displays during dispensing
- **Tank Idle** - Displays when there is no active dispensing, and the minimum height change requirement has been satisfied, but the user has not entered the new volume yet.
- **Start Dispense** - (Metered Dispense Method) Displays when the console is ready to start a metered dispense chart step.
- **Stop Dispense** - (Metered Dispense Method) Displays when the console is ready to end a metered dispense chart step.
- **Start Delivery** - (Metered Drop Method) Displays when the console is ready to start a metered drop chart step.
- **Stop Delivery** - (Metered Drop Method) Displays when the console is ready to end a metered drop chart step.

#### **Add Point**

Touch this button to open the 'Add/Edit Tank Chart Point' dialog box described below:

#### **Point**

New Chart - Automatically displays a 1 for the first point and increments a point at a time as you add points. Edit Chart - Displays the point selected from an existing chart. Allowable range: 1 to 100 points.

#### **Height**

New Chart - Displays 0 and the measured height for additional points. Edit Chart - Displays the entered height for the selected point. Allowable range: 0 to 1200.00 in (0 to 30,480.00 mm)

**Volume**

New Chart - This field is blank - You enter the tank chart value or the metered volume dispensed or dropped for this point. Edit Chart - Displays the volume entered for this point. Allowable range: 0 to 264,172 gal (0 to 999,999 Litres)

**Edit Point**

Touch this button to open the 'Add/Edit Tank Chart Point' dialog box for the selected point (see Add Point button above).

**Delete Point**

Touch this button to remove a selected point from a chart.

**Make Chart**

This button is grayed out until at least 10 points have been entered for a new chart. Touch this button to create a chart from the entered points.

**Setup**

Touch this button to open the 'Tank Chart Setup' dialog box described below:

**Function**

Allowable Selections: Create New Chart, Update Non-Active Chart, or View Chart. Default: Create New Chart.

**Chart Name**

Enter a name for the chart you want to created or for the tank chart you want to view or update.

**New Chart**

Allowable Selection: 1 to 20 alphanumeric characters. Default: Blank

**Existing Chart**

Select from a drop down list of previously created charts

**Source**

Enter the source of chart points for the chart.

Allowable Selections: User Entered, Metered Drop, Metered Dispense. Default: User Entered

**Volume Entry**

Grayed out except for User Entered calibration.

Allowable selections: Total Volume (meter totalizes dispensed amounts) or Volume Change (meter reads dispensed amount). Default: Total Volume

**Max. Step**

This is a read only field showing the volume of the tank at 5% of its capacity. It is recommended that this difference in dropped or dispensed volume not be exceeded between points.

## Tank Setup – Tank Charts

03/03/2010 12:30 PM				All Functions Normal													
Tank Setup – Tank Charts													Tank 1 : regular			Apply	
All Tanks		Product		Chart		Manual Calibration		Tank Charts						Delete			
#	Name		Date & Time			Type		Source...				Rename					
1	*****		03/03/2010 12:29 PM			One Point		User Entered				Diags					
													MORE				

This screen lists the active and inactive charts for the selected tank. Content of the report's columns are described below:

### Name (Chart)

This is the name you entered for the chart.  
Possible format: 20 alphanumeric characters

### Date & Time

This column shows the date the chart was created.  
Message format: MM/DD/YYYY - HH:MM

### Type

The column displays the chart type.  
Possible messages include: 1-point, 4-point, 20-point, Multi-point, Linear.

### Source

Source of the chart.  
Possible messages include: Automatic, Remote, User-Entered, Meter Drop, Meter Dispensed

**Status**

This column lists the chart's status.

Possible messages include: Active, Ready, Incomplete, Bad Point, Calculating

**Quality**

Quality is a combination of data sufficiency and goodness-of-fit. The higher the sufficiency and/or the better the fit, the higher the quality will be. NOTE: This column contains data only if chart type is Automatic or Remote.

Possible messages: 1 to 1000, where 1 = horrible and 1000 = very good

**Control Buttons (right of screen)**

---

The buttons below (except the diags and MORE buttons) are inactive until you have selected (touched) one of the charts in the report.

**Apply**

Touch this button to make the selected chart the active chart for this tank.

**Delete**

Touch this button to delete the selected chart for this tank. NOTE: you cannot delete the first (initial) chart for this tank.

**Rename**

Touch this button to rename the selected chart for this tank.

**Diags (AccuChart II feature)**

Touch this button to display the AccuChart II Diagnostics first tab screen (Delivery Instructions). AccuChart II diagnostic screens will allow you to get information and reports on this tank's charts, and to compare two of this tank's charts.

**MORE**

Touch this button to shift the report to the right to display the last two columns. Touch MORE again to shift the report back to the left.

## Tank Setup - Siphon Sets

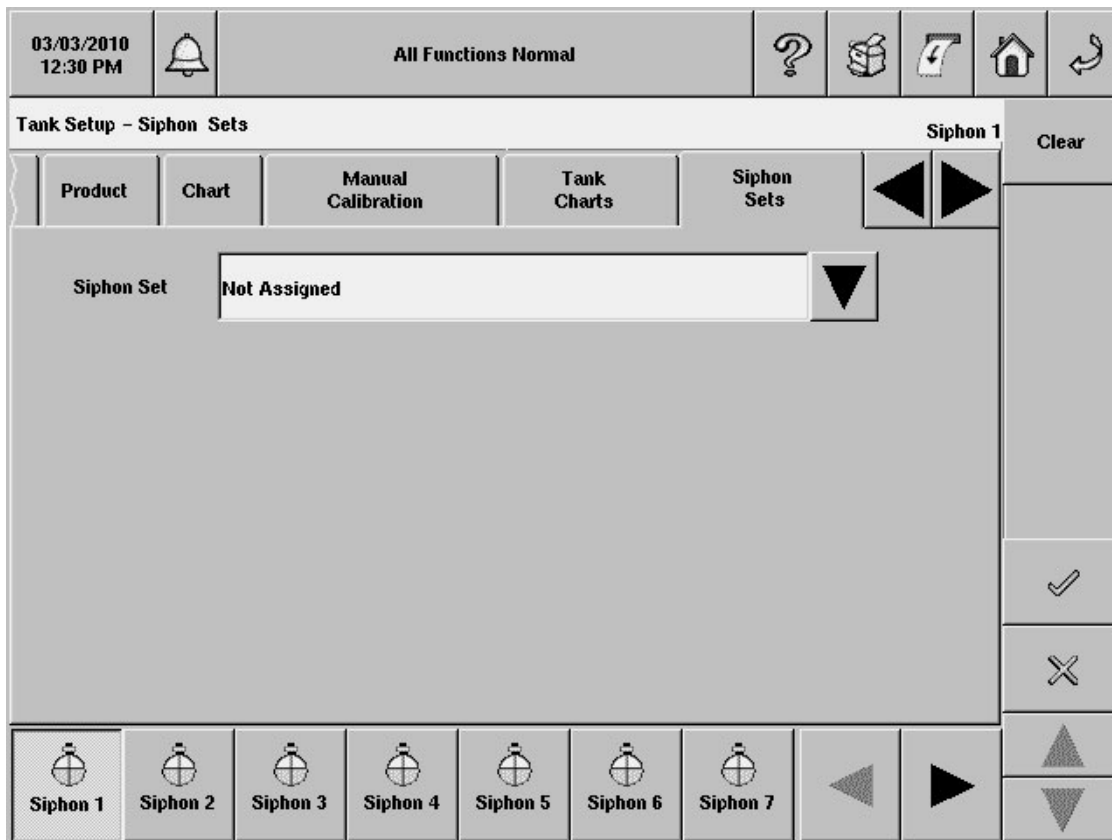

The Siphon Set tab is used to view and edit information about siphon manifolded sets in the system. Each set is composed of a list of tanks that are siphon manifolded together (See Figure 1 below).

The maximum number of Siphon Sets that can be configured is the maximum number of tanks divided by 2, rounded down. To configure tanks, touch the desired button at the bottom of the screen and make the appropriate entries.

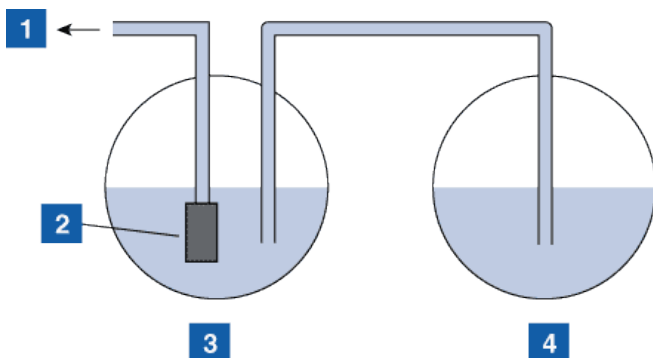

**Figure 1.**  
 Legend: 1 = line to dispensers, 2 = STP, 3 = Primary tank, 4 = Second tank

**Individual Siphon Set Buttons (bottom of screen)**

Touching the individual buttons for Siphon Sets at the bottom of the screen will show parameter entry fields for siphon setup.

A multi-select list of tanks will be provided for picking the tanks to include in the siphon set. The list will contain tanks that are both configured and non-configured. Those tanks include those that have not been assigned to any siphon sets plus those that are assigned to the current set, if any. The tanks that are assigned to the current set will be selected (highlighted). The tanks that are not configured will be prefixed with a '!' symbol to distinguish them from the rest.

This multi-select list will be labeled as Siphon Sets. Initially when a siphon is selected by touching the bottom button, this multi-select list will either contain a comma separated list of tanks for the siphon (e.g., Tank 5: Midgrade, Tank 7: Midgrade), or will be blank if no tanks are present for the siphon. There will be only one parameter entry field labeled "Siphon Set" present initially when a new siphon is selected.

When a new siphon set is created or an existing siphon set is changed either by adding a new tank to the siphon, or removing an already existing tank, the siphon set members selected will be displayed in read only fields below the Siphon Set field (first tank) on the screen .

To delete tanks from the set either deselect each of them from the multi-select list or use the "Clear" button at the right of the screen.

Any operation of creating a new siphon set, changing an existing siphon set or clearing a siphon set should be followed by touching the Save button. Otherwise all changes made to the siphon set will be lost when exiting the screen.

**Siphon Set**

This field will contain the multi-select drop list for tanks to add to the siphon set in ascending order by Tank Device number. If multi-selection alters the contents of the selected Tanks then the screen will be re-drawn to show all fields appropriately sorted based on the Tank they contain, e.g., Second (with assigned tank), Third (with assigned tank), etc.



## Tank Setup - AccuChart II

03/03/2010 12:31 PM		All Functions Normal		?		📦		📄		🏠		↶	
Tank Setup - AccuChart II										Tank 1 : regular		Start	
Chart		Manual Calibration		Tank Charts		Siphon Sets		* AccuChart II		◀		▶	
Update Schedule *		Periodic											
Apply Date 1													
Apply Date 2													
Apply Date 3												✓	
Apply Date 4												✗	
Tank 1		Tank 2		Tank 3		Tank 4		Tank 5		Tank 6		Tank 7	
												▶	
												◀	

### Update Schedule

Descriptions of the available AccuChart II calibration update methods are listed below.

- Immediate** - The active chart is updated every time AccuChart II generates a chart. Any resulting changes in product volume go into effect immediately. The AccuChart II algorithm may generate charts multiple times during the calibration period, so this schedule choice may cause repeated changes in the reported volume of a tank. Alarms will be reported at the end of the calibration period if no charts have been generated and applied
- Periodic** - You can pick up to 4 target dates on which the best chart created by AccuChart II will be made active. This will only occur if there is a chart available on that date. The target date choices will be stored as relative dates to allow easy rescheduling. Although, AccuChart II may generate charts multiple times during the calibration period, it is possible that at the update times chosen in this schedule choice there will be no new chart available. No alarms will be reported for a failure to apply a new calibration except for the final target date.
- Complete** - At the end of the AccuChart II calibration period, AccuChart II will make the last chart generated by AccuChart II active. If no chart is available at the end of the calibration period, appropriate alarms will be generated.

## TLS-450 Setup and Operation Screens Manual

- **Never** - The system will never automatically make any AccuChart II generated chart the active chart. Note: If you have entered another chart type, e.g., a 20 point chart for one of your tanks (ref. the [Tank Setup - Chart](#) tab screen) and you do not want that chart automatically replaced with the AccuChart II version, choose 'Never' for the that tank's Update Schedule.

Allowable selections: Immediate, Periodic, Complete, Never  
Default: Never

### Apply Date 1 - Date 4 Fields

These fields are selectable only if 'Update Schedule' is set to 'Periodic'. Recommended selection is to enter dates 14 days apart, i.e., 14, 28, 42 and 56.

Allowable selections: 0 to 56 days  
Default: 30

### Calibration Period

Your choice here will depend on tank activity. A low throughput tank (premium) may require a longer calibration period than a quick throughput tank (unleaded). For example, you could select start with a 14 day calibration period for the unleaded tank and 30 day calibration period for the premium tank. If at one day prior to the end of your Calibration Period selection, AccuChart II has insufficient data to create a tank chart, it posts a warning (if the AccuChart II Warning field is set to enabled), allowing you the opportunity to extend the Calibration Period.

Allowable selections: 14 to 120 days  
Default: 30

### Days Left to Calibration Completion

This is a read-only field showing the number of days left in the Calibration Period you select above.

Allowable selections: 0 to 120 days  
Default: 30

### Exclude Days

This field lets you select the day(s) to remove AccuChart II calibration data from the Calibration Period. For example, if the site had maintenance performed on a certain day(s), such as meter calibration, you can remove those days from the AccuChart II calibration data.

Allowable selections: Any day(s) from last calibration start or restart, ending today.  
Default: No days

### Enable AccuChart Warnings

In this field you can to post or not to post AccuChart II alarms and warnings.

Allowable selections: Enable or Disable. Default: Enable

### Min Operating Level%

Enter the desired minimum operating height as percent of diameter.

Allowable selections: 0 to 45%. Default: 0%

### **Max Operating Level%**

Enter the desired maximum operating height as percent of diameter.

Allowable selections: 50 to 99%. Default: 99%

### **AccuChart II Notes**

1. If the TLS-450 is powered down during one of the Immediate or Periodic updates, or if a time/date change is made at this time, the update will be missed. If this occurs during the final Periodic update, or at the end of the calibration period for Immediate and Complete update selections, the calibration will be attempted at the next date change. The update will be done with this calibration, or the last generated calibration, or AccuChart II will generate warnings.
2. If you enter the Start Date values in a random order, the system will rearrange them in increasing order. Empty Apply Date 1 through 4 fields will be grouped at the bottom of the set. This may cause the entered values to move around.
3. If the calibration is in progress and the console clock is set back before the start of calibration, the start of calibration will be moved back to the new time, and the 'Update Schedule' dates will all be adjusted appropriately (including Periodic).
4. Touching the 'Start' button will bring up the confirmation dialog. If you click OK, the console will:
  - Set the start of calibration to the current date.
  - Set the Days Left To Calibration Completion equal to the number of days in calibration period.
  - Clear all AccuChart II alarms and warnings.
5. While the calibration is running, the Start button changes to the 'Stop' button. If you touch the Stop button, a confirmation dialog ('Are you sure you want to Stop the AccuChart II Calibration?') will first be displayed before the calibration is stopped. Once you select OK in the confirmation dialog, the Stop button changes to the 'Start' button.

## **Pumps and Lines**

### **PLLD Setup Overview**

The steps below outline basic PLLD setup for standard line leak detection configurations.

- 1) Configure Relays in Device Setup section
  - a. Set 'Label'
  - b. Select desired address from 'Address' drop-down
  - c. Set 'Type' to 'Pump Control Output'
  - d. Set 'Orientation' to desired option
  - e. Set 'Configured' to 'Enabled'
  
- 2) Configure External Inputs in Device Setup section
  - a. Set Label
  - b. Select desired address from 'Address' drop-down
  - c. Set 'Type' to 'Pump Sense'
  - d. Set 'Orientation' to desired option
  - e. Set 'Configured' to 'Enabled'
  
- 3) Configure Line Pressure Sensors in Device Setup section
  - a. Set Label
  - b. Select desired address from 'Address' drop-down
  - c. Set 'Configured' to 'Enabled'
  
- 4) Configure Pumps in Pumps and Lines Setup section
  - a. Set 'Pump Label'
  - b. Set 'Mode' to 'TLS Pump Control'
  - c. Select desired tank from 'Tank' drop-down
  - d. Select desired relay from 'Pump Control' drop-down
  - e. Select desired external input from 'Pump Sense' drop-down
  - f. Set 'Configured' to 'Enabled'
  
- 5) Configure Lines in Pumps and Lines Setup section
  - a. Set 'Line Label'
  - b. Set 'Leak Monitoring' to 'PLLD'
  - c. Select desired pressure sensor from 'Pressure Sensor' drop-down
  - d. Set 'Manifolded' according to hardware configuration
  - e. Select desired pump(s) from 'Pumps' drop-down
  - f. Set 'Configured' to 'Enabled'
  
- 6) Configure PLLD in Pumps and Lines Setup section
  - a. Select desired pump from 'Controlling Pump' drop-down if more than one pump is configured for a single line
  - b. Set 'Pipe Type' according to hardware configuration
  - c. Set 'Line Length', ';Diameter Length', 'Line Diameter', and 'Bulk Modulus' fields according to hardware configuration
  - d. Set '0.2 gph (0.76 lph) Line Leak Test' field to desired 0.2 gph (0.76 lph) test schedule
  - e. Set '0.1 gph (0.38 lph) Line Leak Test' field to desired 0.1 gph (0.38 lph) test schedule
  - f. Set 'Shutdown Rate' to desired leak rate
  
- 7) Set remaining PLLD settings as needed.

## Pumps and Lines Setup - Pumps

2007/11/05 02:19 PM		All Functions Normal				
Pump and Line Setup - Pumps						Pump 1 :
<b>Pumps</b>	All Lines	Lines	All PLLD	PLLD		
Configured	Enabled					
Pump Label	<input type="text"/>					
Mode	TLS Pump Control					
Tank	!Tank 1:					
Pump Control	Not Assigned					
Pump 1	Pump 2	Pump 3	Pump 4	Pump 5	Pump 6	Pump 7

This tab screen allows you to configure the site's pumps that will be monitored by the console.

### Configured

This selection sets up the console to monitor the selected pump. The maximum number of pumps that can be configured is equal to the maximum number of tanks as defined by your console's installed features.

Allowable selections: Enabled, Disabled. Default: Disabled

### Pump Label

Enter a unique label or name for the selected pump.

Allowable selections: Up to 20 alphanumeric characters - must be unique for each pump. Default: Blank

### Mode

Select how the selected pump is to be controlled:

- **TLS Pump Control** - Pump is controlled or actuated locally by the console. Pump control and pump sense assignments are required for the pump's setup. Pump sense is used as a pump request signal to ask the console to turn on/off the pump. This signal doubles as a tank active signal to the console.

## TLS-450 Setup and Operation Screens Manual

- **Pump Sense** - This input is used to identify a tank active condition. A pump sense input assignment is required for this mode selection. There is no pump control assignment for this mode selection.
- **External Pump Control** - This mode is used to identify tanks that are line manifolded together. Control of the pump is done externally to the console. There are no pump control or pump sense input assignments for this pump mode selection.

Allowable selections: TLS Pump Control, Pump Sense or External Pump Control  
Default: TLS Pump Control

### Tank

Select the tank in which the selected pump is installed.

Note: There may be both configured and non-configured items on this drop-down list. Non-configured items will be prefixed by a "!".

Allowable selections: Not assigned, or a selection from a list of available tanks.  
Default: Not Assigned

### Pump Control

This feature includes a list of pump controlling devices that respond to dispense requests. The list of pump controlling devices will include relays that have been configured as pump controlling devices that actuate the selected pump. Select from the list of relays for pump control that were assigned in Device Setup - Relays.

Pump control relay assignments are usually unique for each pump. A warning dialog will display if the pump control selected is already assigned to another pump - this alert is not an alarm or error since some sites use a single pump control output for more than one pump.

This field is enabled for edit only when the Mode entry is "TLS Pump Control".

Note: There may be both configured and non-configured items on this drop-down list. Non-configured items will be prefixed by a "!".

Allowable selections: Not assigned, or a selection from a list of available pump controlling devices.  
Default: Not Assigned

### Pump Sense

In this field you select how the console will determine when the pump is on or off. Inputs for pump sense are selected from a list of defined or configured pump sense external inputs that were assigned in Device Setup - External Inputs. Selecting a pump sense input enables pump sense for the selected pump. More than one pump may use the same pump sense input. This feature is only enabled if Mode entry is "TLS Pump Control" or "Pump Sense".

Note: There may be both configured and non-configured items on this drop-down list. Non-configured items will be prefixed by a "!".

Allowable selections: Not assigned, or a selection from a list of available pump sense external inputs.  
Default: Not Assigned

### Line

This is a read-only field displaying either the line identifier of the selected pump, or "Not Assigned", if such is the case. Note: Non-configured items will be prefixed by a "!".

## Pumps and Lines Setup - Lines

07/14/2010 09:25 AM		Pm 1: PUMP OUT								
Pump and Line Setup - Lines									Line 1 :	
<b>Pumps</b>	<b>All Lines</b>	<b>Lines</b>	<b>All PLLD</b>	<b>PLLD</b>						
<b>Configured</b>	Enabled									
<b>Line Label</b>	<input type="text"/>									
<b>Leak Monitoring</b>	PLLD									
<b>Pressure Sensor</b>	! LPR Sensor 1:									
<b>Line ManifolDED</b>	No									
Line 1	Line 2	Line 3	Line 4	Line 5	Line 6	Line 7				

A line consists of one or more pumps in the site. Lines are collections of pumps that are treated as a group or set. Each line or line set is given a name or label that can be used by the console to refer to the pumps in the line. The maximum number of lines that can be configured is equal to the Maximum Number of Tanks your console was programmed to monitor when purchased.

A line is considered manifolded if it contains more than one pump. Pumps are added to a line using a drop down list of available pumps. The number of fields that follow will depend on the number of pumps selected from the list.

### Configured

Allowable selections: Enabled, Disabled. Default: Disabled

### Line Label

Allowable selections: 20 alphanumeric characters (must be unique for each line), Blank  
Default: Blank

### Leak Monitoring

Allowable selections: None, PLLD. Default: None

### **Pressure Sensor**

Allowable selections: Choose from drop-down list of available sensors (you should pick the pressure sensor assigned to this line), Not Assigned. Default: Not Assigned

### **Manifolded**

Allowable selections: Yes, No. Default: No

### **Dispense Mode**

This field is disabled for edit unless the Manifolded field is set to "Yes". For non-manifolded lines, the dispense mode is set to Standard by default. If the mode selected in pump setup was TLS Pump Control then all options are available and the default is Standard. Otherwise for other modes selected in pump setup, the only option for dispense mode is Standard.

Options for dispense mode are:

- Standard - Typically this means that only one pump feeds the line. However if the selected pump mode is External Pump Control this is not the case since the console is not controlling the actuator/control for the pump.
- Alternate - If there is more than one tank with a pump on the line, the console will actuate the pump to run the tank with the greatest inventory volume.
- Sequential - If there is more than one tank with a pump on the line, tanks are pumped low one at a time until volume drops below pump threshold percentage. At that point pumping will commence on the next available tank in the line set.
- All - All pumps on the line are run.

### **Pumps**

A multi-select list of pumps will be provided for picking the pumps you can assign to the selected line. The multi-select drop down list for this field will contain pumps defined in the console that are both configured and non-configured and include those that have been assigned to the selected line plus those that have not been assigned to any line. The pumps that are assigned to the current line will be highlighted. The pumps that are not configured will be prefixed with a "!" symbol to distinguish them from the rest. After all pumps have been selected for the set, they will be displayed in the Pumps field separated by a colon (:).

Pumps selected for a line should have the same pump mode setting or an error message box will be shown describing why the selected pump cannot be added to the list.

The maximum number of pumps that can be added to a single line is 8.

Allowable selections: Choose from drop-down list of available pumps, Not Assigned  
Default: Not Assigned



## Pumps and Lines Setup - All Lines

2007/11/05 02:19 PM		All Functions Normal				
Pump and Line Setup - All Lines						All Lines
Pumps	All Lines	Lines	All PLLD	PLLD		
Line Lockout Schedule	Daily					
Start Time	12:00 AM					
End Time	12:00 PM					

The line leak detection system cannot test a line when AC power to the submersible pump is shut off. Since the line leak system automatically attempts to conduct a test whenever it receives a signal that the dispenser is off, it is necessary to lock out line tests when the station or fueling site is shut down and submersible pump power is off. In some areas, regulations prohibit leaving power to submersibles switched on during hours when the site is unattended. The Line Lockout Schedule provides a flexible means of locking out line leak tests in accordance with business hours.

The Lockout schedule identifies the hours not to run line leak tests for the station.

Allowable selections: Disabled, Daily, Individual (see explanations below). Default: Disabled

### Line Lockout Schedule - Daily

Daily schedule allows you to enter a Lockout Start Time and Stop Time. The lockout period will begin and end at the times you enter every day of the week. Note: By using a Daily schedule and entering the same Start and Stop Times, you can lock out the line leak test function 24 hours per day.

#### Start Time

Allowable selections: HH:MM am/pm. Default: 12 pm

### **Stop Time**

Allowable selections: HH:MM am/pm. Default:12 pm

### **Line Lockout Schedule - Individual**

---

Individual schedule allows you to enter up to seven separate lockout schedules. You program each lockout period with an Event Start day and time, and an Event End day and time. For example, lockouts 1 through 5 could be programmed to lock out the line leak test each day from Monday through Friday to accommodate hours when the station is closed. Lockout 6 could be programmed to lock out the test from Friday night to Monday morning if the site is closed for the weekend.

If lockout schedules are programmed incorrectly, the line leak tests may not run. Make sure you have programmed the settings correctly.

### **Event Start**

Allowable selections: Disabled, Monday - Sunday  
Default: Disabled

### **Start Time**

If a start date is selected, a start time is selectable.

Allowable selections: HH:MM am/pm  
Default:12 pm

### **Event End**

Allowable selections: Disabled, Monday - Sunday  
Default: Disabled

### **End Time**

If an end date is selected, an end time is selectable.

Allowable selections: HH:MM am/pm  
Default: 12 pm

Repeat the above procedure for additional Individual Lockout Schedule Event Start/End selections (up to 5).

## Pumps and Lines Setup - All PLLD

2007/11/06 02:39 PM			T 1: DELIVERY NEEDED					
Pump and Line Setup - All PLLD								All PLLD
Pumps	All Lines	Lines	All PLLD	PLLD				
<b>Line Re-Enable Method</b>		Pass Line Test						
<b>Periodic Test Warnings</b>		Disabled						
Days before Periodic Warning		25						
Days before Periodic Alarm		30						
<b>Annual Test Warnings</b>		Disabled						
Days before Annual Warning		355						

This tab screen lets you setup test parameters for all Pressurized Line Leak Detectors (requires PLLD option).

### Line Re-Enable Method

Allowable selections: Pass line test, Alarm acknowledge  
Default: Pass line test

### Periodic Test Needed Warning

Periodic Test Needed Warning, when enabled, informs you that a line will soon be out of compliance because a Periodic test has not completed within the required time. The Periodic Test Warning lets you take action (shut down the line) to see that a Periodic test is completed.

Allowable selections: Disabled, Enabled  
Default: Disabled

### Days Before Periodic Warning

Allowable selections: 0 - 30 days  
Default: 25 days

**Days Before Periodic Alarm**

Allowable selections: 0 - 30 days  
Default: 30 days

**Annual Test Needed Warning**

Annual Test Needed Warning, when enabled, informs you that a line will soon be out of compliance because an Annual test has not completed within the required time. The Annual Test Warning lets you take action (shut down the line) to see that an Annual test is completed.

Allowable selections: Disabled, Enabled  
Default: Disabled

**Days Before Annual Warning**

Allowable selections: 0 - 365 days  
Default: 355 days

**Days Before Annual Alarm**

Allowable selections: 0 - 365 days  
Default: 365 days

**Precision Test Delay (hours)**

Entering a non-zero value in this field enables the time to wait or extend between a passed periodic and annual test and running the next line test(s). Note: In previous TLS consoles this was referred to as Precision Test Duration.

Allowable selections: 12 to 744 hours  
Default selection: 12 hours

Note: when CSLD is enabled for the tank assigned to the line, a minimum value of 60 hours is used internally when the precision test delay value is less than 60.

**0.1 gph (0.38 lph) Line Test Auto Confirm**

Enabling this feature causes the console to evaluate several 0.1 gph (0.38 lph) line tests before a result is posted. Enabling Auto Confirm reduces the risks of false test results, however it extends the time that it may take to post 0.1 gph (0.38 lph) line test results.

Allowable selections: Disabled, Enabled  
Default: Enabled

**0.2 gph (0.76 lph) Line Test Auto Confirm**

Enabling this feature causes the console to evaluate several 0.2 gph (0.76 lph) line tests before a result is posted. Enabling Auto Confirm reduces the risks of false test results, however it extends the time that it may take to post 0.2 gph (0.76 lph) line test results.

Allowable selections: Disabled, Enabled  
Default: Enabled

## Pumps and Lines Setup - PLLD

2007/11/06 04:00 PM		T 3: HIGH PRODUCT ALARM				
Pump and Line Setup - PLLD						Line 1 :
Pumps	All Lines	Lines	All PLLD	PLLD		
	Configure	Enabled				
	Controlling Pump	Not Assigned				
	Pipe Type	Enviroflex PP1503/2503				
1.5 in Diameter Length [Ft]		<input type="text"/>				
2.5 in Diameter Length [Ft]		0				
Line 1	Line 2	Line 3	Line 4	Line 5	Line 6	Line 7

In this screen you setup parameters for individual lines having Pressurized Line Leak Detection or PLLD. It will only be visible for consoles having the PLLD option. Also, if Leak Monitoring is not enabled (in Lines Setup) for at least one line then none of the PLLD screens will be editable.

The maximum number of Lines that can be configured for Leak Detection is equal to the Maximum Number of Tanks as determined by your console. However, only those Lines for which the Leak Monitoring is enabled (in Lines Setup) will be shown on the lines buttons at the bottom of the screen.

Automatic dialing or sending of PLLD alarms is setup in Automatic Events setup. Shutdown for PLLD alarms is also done as part of the Automatic Events setup. This includes the 'no line', 'single line', and 'all line' shutdown for PLLD.

### Configure

Allowable selections: Disabled, Enabled  
Default: Enabled

### Controlling Pump

Allowable selections: Select pump from a drop-down Assigned Pumps list.  
Default: First on the list of Assigned Pumps for a Line or 'Not Assigned' if list is empty.

### Pipe Type

Note: If you select "user defined" pipe type, advanced fields for setting up the 1st and 2nd line diameters, line lengths, and bulk modulus will be displayed.

Allowable selections: See Table 1 below. Default: Environflex PP1503/2503

**TABLE 1.**

<b>Pipe Type</b>	<b>Line Length, 1.5 Diameter Line Length, 2.0 Diameter Line Length, and 1st Line Length Fields</b>	<b>2.5 Diameter Line Length, 3.0 Diameter Line Length, and 2nd Line Length Fields</b>
2/3 IN. FIBERGLASS	10 - 500ft (3 - 152m)	10 - 220ft (3 - 67m)
2 IN. STEEL	30 - 500ft (10 - 152m)	N/A
1.5 IN. ENVIRN GLEXII	10 - 500ft (3 - 152m)	N/A
OMNIFLEX CP1501	30 - 500ft (10 - 152m)	N/A
OPW PISCES SP15	10 - 500ft (3 - 152m)	N/A
OPW PISCES CP15	10 - 500ft (3 - 152m)	N/A
WFG COFLX2000 RIBBED	10 - 500ft (3 - 152m)	N/A
ENVIROFLEX PP1503/2503	40 - 500ft (12 - 152m)	40 - 350ft (12 - 106m)
OMNIFLEX CP1503	30 - 500ft (10 - 152m)	N/A
1.5/2 IN. ENVIRN GFLXD	30 - 500ft (10 - 152m)	30 - 350ft (10 - 106m)
APT P175SC	20 - 1100ft (6 - 335m)	N/A
OPW PISCES CP15DW	30 - 500ft (10 - 152m)	N/A
OPW PISCES CP20	30 - 500ft (10 - 152m)	N/A
OPW PISCES SP20	20 - 1100ft (6 - 335m)	N/A
USER DEFINED	20 - 1100ft (6 - 335m)	20 - 1100ft (6 - 335m)
PETROTECHNIK UPP EXTRA 63MM	20 - 1100ft (6 - 335m)	N/A

**Line Length**

This field entry is the length of the piping between the tank and the dispensers. It includes the length between the check valve and where it connects into the product line. Line lengths are integer values. Values are in foot or meter increments depending on system units.

Allowable selections: See Table 1 above  
 Default is 0 and will cause a data setup warning.

**1.5 in Diameter Length**

Allowable selections: See Table 1 above  
 Default is 0 and will cause a data setup warning.

**2.5 in Diameter Length**

Allowable selections: See Table 1 above  
 Default is 0 and will cause a data setup warning.

**2.0 in Diameter Length**

Allowable selections: See Table 1 above  
 Default is 0 and will cause a data setup warning.

**3.0 in Diameter Length**

Allowable selections: See Table 1 above  
 Default is 0 and will cause a data setup warning.

### **1st Line Length**

Allowable selections: See Table 1 above  
Default is 0 and will cause a data setup warning.

### **1st Line Diameter**

Allowable selections: 0 to 3.00 in (0 to 76.20mm)  
Default is 0 and user can set this field back to default. It will cause a data setup warning if associated line length is non-zero and Line Diameter is still default.

### **Configure**

Allowable selections: Disabled, Enabled  
Default: Enabled

### **1st Line Bulk Modulus**

Allowable selections: 1000 to 200,000 psi (6892 to 1,378,359kPa)  
Default is 0 and user can set this field back to default. It will cause a data setup warning if associated line length is non-zero and Bulk Modulus is still default.

### **2nd Line Length**

Allowable selections: See Table 1 above  
Default: 0

### **2nd Line Diameter**

Allowable selections: 0 to 3.00 in (0 to 76.20mm)  
Default is 0 and user can set this field back to default. It will cause a data setup warning if associated line length is non-zero and Line Diameter is still default.

### **2nd Line Bulk Modulus**

Allowable selections: 1000 to 200,000 psi (6892 to 1,378,359kPa)  
Default is 0 and user can set this field back to default. It will cause a data setup warning if associated line length is non-zero and Bulk Modulus is still default.

### **Thermal Coefficient**

If the controlling pump assigned to the line has a tank assignment, then use the thermal coefficient from that tank (see Tank Setup - General tab screen). In this case the field is read only. If there is not a tank assignment, the field is enabled for edit. If the tank assignment is removed, the system will use the default.

Allowable selections: 0.0 to 0.0016 gal/gal/°F (0.0 to 0.00288L/L/°C)  
Default: 0.00070

### **0.2 gph (0.76lph) Line Leak Test**

This feature allows the user to choose the scheduling frequency of the 0.2 gph (0.76lph) periodic tests.

Allowable selections:

- **Disabled** - No manual or automatic 0.2 gph (0.76lph) testing is allowed.
- **Repetitive** - After a dispense, a 3.0 gph (11.3lph) test is run, followed by a 0.2 gph (0.76lph) test. The test blockout period (selected in Precision Test Duration setup) is then observed. Following

## TLS-450 Setup and Operation Screens Manual

the test blockout period, the test sequence repeats after the next dispense. This selection also enables manual 0.2 gph (0.76lph) testing.

- **Monthly** - At the beginning of every month until a test has passed. This selection also enables manual 0.2 gph (0.76lph) testing.
- **Manual** - 0.2 gph (0.76lph) tests run only when manually started.

Default: Disabled

### **0.1 gph (0.38lph) Line Leak Test**

This feature allows the user to choose the scheduling frequency of the 0.1 gph (0.38lph) precision tests.

Allowable selections:

- **Disabled** - No manual or automatic 0.1 gph (0.3 lph) testing is allowed.
- **Repetitive** - After a dispense, a 3.0 gph (11.3lph) test is run, a 0.2 gph (0.76lph) test is run, followed by the 0.1 gph (0.38lph) test. The test blockout period (selected in Precision Test Delay setup) is then observed. Following the test blockout period, the test sequence repeats after the next dispense. This selection also enables manual 0.1 gph (0.38lph) testing. (Note: The Repetitive option is not available if the 0.1 (0.38lph) On Demand PLLD software feature is installed.)
- **Auto** - 6 months after the last passed 0.1 gph (0.38lph) test. Also enables manual 0.1 gph (0.38lph) testing.
- **Manual** - 0.1 gph (0.38lph) tests run only when manually started.

Default: Disabled

### **Passive 0.1 gph (0.38lph) Line Leak Test**

Allowable selections: Yes, No

Default: No

### **Shutdown Rate**

Allowable selections: Line Leak tests in system: 3.0 gph (11.3lph), 0.2 gph (0.76lph), 0.1gph (0.38lph), or None

Default: 3.0 gph (11.3lph)

### **Low Pressure Shutoff**

Allowable selections: Disabled, Enabled

Default: Disabled

### **Low Pressure Shutoff Value**

Allowable selections: 0 to 25 psi (0 to 172kPa)

Default: 0

### **Continuous Handle Timeout**

Allowable selections: 1 to 16 hours

Default: 16 hours











### **Fuel Out Limit**

Allowable selections: 0.00 to 15.00 in (0.00 to 381.00mm). Default: 10.00 in (254mm)



## Custom Alarms

### Custom Alarms Setup - Enable

2007/11/05 02:27 PM		All Functions Normal				
Custom Alarms - Enable						
Enable	View	Setup				
Custom Alarms	Enabled 					
						
						
						
						

The Custom Alarms Setup - Enable screen gives you the option of entering custom alarm labels that will accompany the system's alarm labels in printouts and in the system status display.

#### Custom Alarms

Lets you create custom alarm labels or important information that will display along with the console's standard alarm labels.

Allowable selections: Enabled/Disabled

Default selection: Disabled

## Custom Alarms Setup - View

2007/11/05 02:30 PM				All Functions Normal									
Custom Alarms - View											More		
Enable		View		Setup									
Device Type	Dev. No.	Alarm Description	Custom Alarm Description	LCD Indication									
VAPOR SENSOR	ALL	WATER ALARM		Yes									
COMM		ALARM CLEAR WARNING		Yes									
PRODUCT	ALL	CLOSE SHIFT WARNING		Yes									
PRODUCT	ALL	HRM RECON WARNIG		No									
PLLD LINE	Q 1	PLLD PUMP ON WARN		Yes									
PLLD LINE	Q 1	FUEL OUT		Yes									
HOSE	ALL	GROSS COLLECT WARN		Yes									
HOSE	ALL	FLOW COLLECT FAIL		No									

The Custom Alarms Setup - View screen lets you view a report listing all of the alarms that have either custom alarm labels and/or modified indication flags i.e., LCD flag, LED flag and Beeper flag.

### Report Column Descriptions

#### Device Type

Lists the device type.

#### Device Number

Lists the device number. The Device Number displays 'ALL' if the alarm label is set for all devices for that particular device. If the custom alarm label is set for all devices and also for any particular device, an asterisk follows the all (ALL\*).

#### Alarm Description

Lists the system standard alarm label for the device.

**Custom Alarm Description**

Lists the custom alarm label (if any).

**LCD Indication**

Lists if a LCD flag is enabled/disabled following an alarm by this device.

**LED Indication**

Lists if the front panel LED flag is enabled/disabled following an alarm by this device.

**BEEP Indication**

Lists if the console's beeper is enabled/disabled following an alarm by this device.

## Custom Alarms - Setup

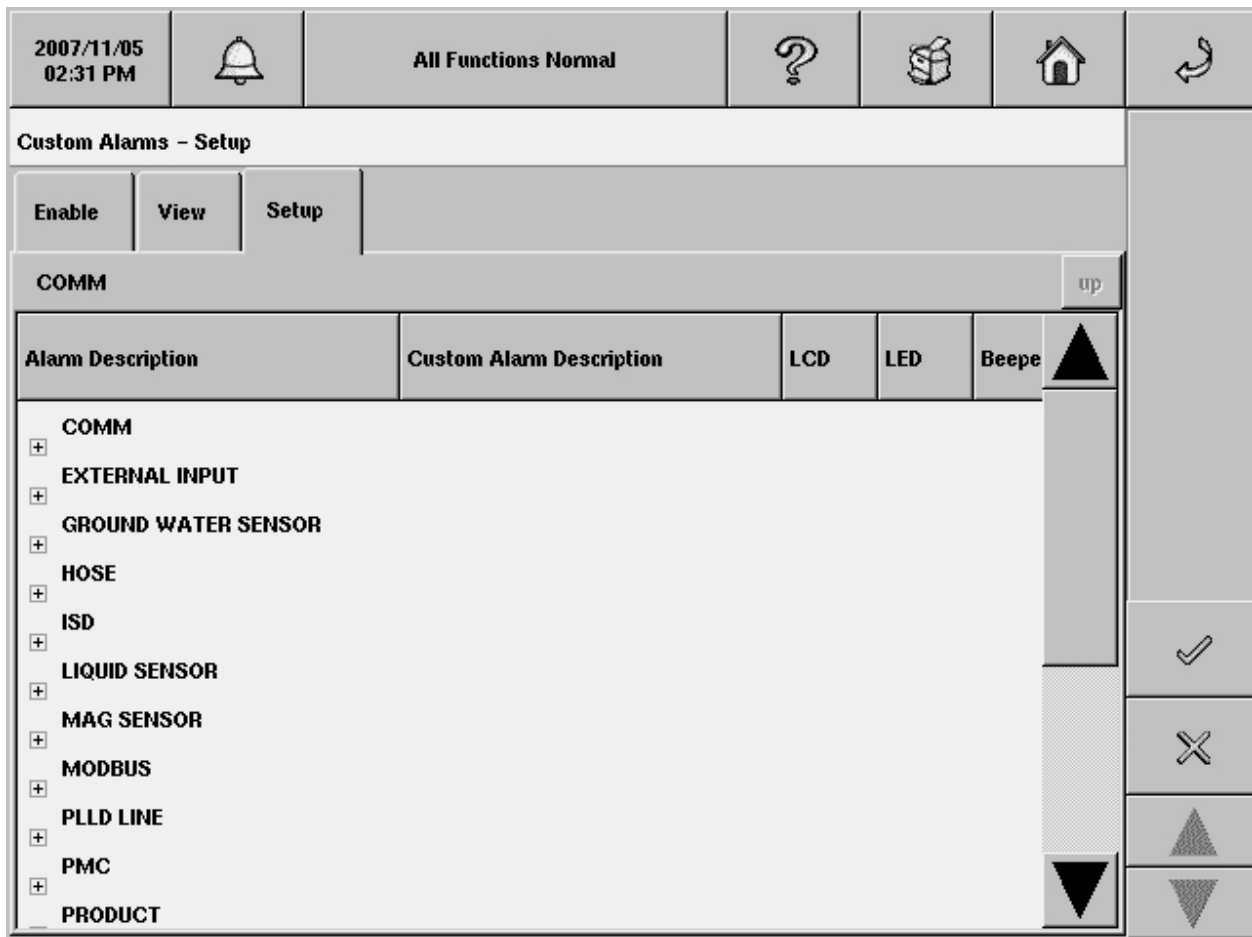

The Custom Alarms Setup screen can be used to enter a custom alarm label and also select the alarm indicators for the alarm.

The data view area contains the list of alarm categories. Touching a category displays all of the standard alarm labels within that alarm category.

To enter a custom alarm label, select an alarm category and then select the alarm you want to re-label. This opens the Customization of Alarms dialog box with the following fields:

### LCD Indication

The alarm will display in the system status area when this alarm occurs.

Allowable selections: Enabled/ Disabled

Default selection: Enabled

### LED Indication

A front panel LED will activate when this alarm occurs.

Allowable selections: Enabled/ Disabled. Default selection: Enabled

**BEEP Indication**

The console beeper will activate when this alarm occurs.

Allowable selections: Enabled/ Disabled

Default selection: Enabled

**Alarm Description**

The standard alarm label is listed for this alarm.

**Custom Alarm Label**

Enter your custom alarm label that will be displayed along with the standard alarm label when this alarm occurs.

Allowable selection: 1 to 20 alphanumeric characters

Default selection: Blank

**Control Button (on right of screen)**

---

**Clear All**

The Clear All button appears only when an alarm category is selected (e.g., Tank). Touching the Clear All button clears all the Custom Alarm Labels and resets the indication flags to default for the particular device (e.g., Tank 1).

## Custom Help

### Custom Help Setup - Enable

2007/11/05 02:31 PM		All Functions Normal				
Custom Help Setup - Enable						
Enable	Alarms					
Custom Help View	Enabled					
Custom Help Edit	Enabled					

The Custom Help Setup Enable screen allows you to add custom help text to console online help topics and to select whether or not to display the custom help text and allow access to the custom help edit feature.

#### Custom Help View

This field selects whether or not the custom help you create for online help topic(s), displays when the online help topic(s) is selected.

Allowable selections: Enabled, Disabled

Default selection: Disabled

#### Custom Help Edit

This field lets you enable the online help Create/Edit feature when an online help topic is viewed. When enabled, the user can create/edit custom help for any online help topic. When disabled, the Create/Edit button is removed from the top of the online help screen.

Note: Custom Help is displayed at the beginning of the system online help topic, it does not replace the system online help topic.

Allowable selections: Enabled, Disabled. Default selection: Disabled

## Custom Help Setup - Alarms

2007/11/05 02:32 PM		All Functions Normal				
Custom Help Setup - Alarms						Create/ Edit
Enable	Alarms					View
Alarm Category	COMM					
Alarm Type	ALARM CLEAR WARNING					

The Custom Help Setup - Alarm screen lets you create custom text that is assigned to a selected alarm and that will display when that alarm occurs and the user requests [cause/action information about the alarm](#).

### Alarm Category

Select the desired alarm category using the drop-down box.

### Alarm Type

Select the desired alarm type for the selected category using the drop-down box.

### Control Buttons (on right of screen)

---

#### Create/Edit

Touch this button to open an editor and enter the custom information you want to display with this alarm's default information.

#### View

Touch this button to view existing custom information (if any) for this alarm. Clicking on the Help link in the Information screen, displays the default information for that alarm.

# Inventory

## Inventory Setup - Shift Close Method

07/14/2010 09:19 AM		T 1: SETUP DATA WARNING					
Inventory Setup - Shift Close Method							
Shift Close Method		Shift Times	Inventory Report Times				
Shift Close Method	MANUAL						
Shift Close Timeout	30						
Max. Number of Shift/Day	3						

This screen lets you setup daily shifts. At least one shift must be selected or the feature is disabled.

### Shift Close Method

Touch the down arrow to select either 'Timed' or 'Manual' shift close method.

#### NOTES:

1. When shift closing is set to 'Timed', a manual shift close will close the shift for ALL tanks, but the tank(s) must be idle before a shift can close. Once a 'Timed' shift has been closed, no other shift can be closed until the shift duration ends.
2. When shift close is set to 'Manual', BIR manual shift close can be applied to all tanks or to an individual tank. The BIR tank will immediately close when the operator makes the request. There is no waiting or idle time. The remaining open tanks must be closed within 30 minutes (default Shift Close Timeout setting). Tanks open after the shift close timeout has expired will be automatically closed.



## **TLS-450 Setup and Operation Screens Manual**

3. A new Shift Inventory report will be created and will include the shift number, and allow you to access current or historical reports.

Allowable selections: Timed, Manual  
Default: Timed

### **Shift Close Timeout**

Select a Shift Close Timeout period (Manual Shift Close Method only).

Allowable selections: 3 to 60 minutes  
Default: 30 minutes

### **Max. Number of Shifts/Day**

Enter the desired number of shifts per day (Manual Shift Close Method only).

Allowable selections: 1 to 8  
Default: 3

## Inventory Setup - Shift Times

03/03/2010 12:36 PM		T 1: SETUP DATA WARNING					
Inventory Setup - Shift Times							
Shift Close Method	Shift Times	Inventory Report Times					
Shift 1	Disabled						
Shift 2	Disabled						
Shift 3	Disabled						
Shift 4	Disabled						
Shift 5	Disabled						
Shift 6	Disabled						

When the selected shift close method is 'Timed', this screen lets you setup start times for each of the previously selected number of timed shifts (up to eight).

### Shift 1 (up to Shift 8)

Touch the down arrow to the right of each shift to select a desired start time. Repeat for each remaining shift.

Allowable selections: Hour: 0 - 23 (or 1-12 if 12 Hr Format), Minute: 0 - 59, Meridiem: AM, PM (if 12 Hr Format) or Disabled

Default: Disabled

## Inventory Setup - Inventory Report Times

03/03/2010 12:36 PM		T 1: SETUP DATA WARNING					
Inventory Setup - Inventory Report Times							
Shift Close Method		Shift Times		Inventory Report Times			
Reporting Interval	24 Hours						
Storage Length							
Log Start Time	12:00 AM						

This screen lets you setup Inventory Report Times.

### Reporting Interval

Allowable selections: Disabled, 5 min, 10 min, 15 min, 20 min, 30 min, 1 hr, 2 hrs, 3 hrs, 4 hrs, 6 hrs, 8 hrs, 12 hrs or 24 hrs

Default: Disabled

### Storage Length

This is a read-only field which displays the maximum number of records..

### Log Start Time

Allowable selections: Hour: 0 to 23 (or 1 to 12 if 12 Hr Format); Minute: 0 to 59; Meridiem: AM, PM (if 12 Hr Format)

Default: 12:00 AM (if 12 Hr Format); 12:00 (if 24 Hr Format)

## Delivery

### Delivery Setup

03/03/2010 12:38 PM		T 1: SETUP DATA WARNING					
<b>Delivery Setup</b>							
<b>Delivery Method</b>	Standard Automatic						
<b>Ticketed Delivery *</b>	Enabled						
<b>TC Ticketed Delivery</b>	Standard						

#### Delivery Method

Allowable selections: Standard, Manual or Automatic Quiet Period  
Default: Standard

#### Ticketed Delivery

When you enable ticketed delivery, you can manually enter ticketed volumes using the receipts from delivery trucks. Enabling this feature generates reports showing delivery variances between ticketed volume and gauged volume and book variance.

Allowable selections: Enabled or Disabled  
Default: Disabled

#### TC Ticketed Delivery

If you enabled ticketed delivery, you can choose whether the values you enter are standard (gross) volumes or temperature-compensated (TC) volumes. This field must be enabled for TC volumes to be included on the Delivery Reports.

Allowable selections: Standard or TC Volume. Default: Standard

## Reconciliation

### Reconciliation Setup - General

03/03/2010 12:39 PM		T 1: SETUP DATA WARNING					
Reconciliation Setup - General							
* General		Threshold Alarms					
Product Threshold Alarm *	Enabled						
Daily Close Time	02:00 AM						
Week Close Day	Sunday						
Alarm Threshold Delivery Type	Standard						
Temperature Compensation	Standard						
Meter Calibration Offset %	0.00						

This screen lets you setup general Reconciliation parameters.

#### Product Threshold Alarm

If enabled, the Product Threshold Alarm will be activated when the programmed threshold for discrepancies between the fuel delivered amount and the dispensed fuel amount is exceeded. The system default is 1.00% of total meter sales (throughput) plus 130 gallons (492 litres) offset. In the U.S. the EPA has set this default as a criteria not to be exceeded. The Product Threshold Alarm is triggered when the Alarm Threshold plus offset exceeds the allowed variance.

Allowable selections: Enabled, Disabled  
Default: Disabled

#### Daily Close Time

Enter the time you wish to designate as the daily closing time. At the programmed time, the system stores the current day's data, and prints a report. This feature cannot be disabled.

Allowable Selections:

- Hour: 0 to 23 (1 to 12 if 12 hour format)

## **TLS-450 Setup and Operation Screens Manual**

- Minute: 0 to 59
- Meridiem: AM, PM (if 12 hour format)

Default: 02:00 (02:00 AM if 12 hour format)

### **Week Close Day**

Allowable selections: Sunday to Saturday

Default: Sunday

### **Alarm Threshold Delivery Type**

Alarm Threshold Delivery Type field is disabled (grayed out) when Ticketed Delivery is disabled. When Ticketed Delivery is enabled, the selections for this field are Standard or Ticketed. If Alarm Threshold Delivery type is set to Standard, the variance calculated by Periodic Reconciliation Report will be used. If set to Ticketed, the variance calculated by Book Variance Report will be used to trigger the Product Threshold Alarm.

Allowable selections: Standard, Ticketed

Default: Standard

### **Temperature Compensation**

This field allows you to choose whether or not to calculate Business Inventory Reconciliation (BIR) volumes using the Programmable Temperature Compensation (TC) value. Select STANDARD (the default) if the meters are not temperature compensated. Select TC VOLUME if the meters are temperature compensated (the calculation of all BIR volumes will be based on the TC value).

Allowable selections: Standard or TC Volume

Default: Disabled

### **Meter Calibration Offset%**

The Meter Calibration offset applies to all of the site's dispenser meters and is applied to the dispensed amount received. The default value is 0.000%.

Allowable selections: -1.000 to +1.000

Default: +0.000

### **BIR Status Warning Enable**

Allowable selections: Enabled, Disabled

Default: Disabled

### **BIR Shift Close Warning Enable**

Allowable selections: Enabled, Disabled

Default: Disabled

### **BIR Daily Close Warning Enable**

Allowable selections: Enabled, Disabled

Default: Disabled

## Reconciliation Setup - Threshold Alarms

This screen contains information that allows you to select up to four reconciliation compliance monitoring test protocols.

You select one or more threshold determining references for each test protocol. The reference selections are: throughput, tank capacity, deliveries, or a fixed value. You input percentage and offset values that are applied to the reference selection to determine the threshold value. In the case of multiple references the largest threshold value is used to determine the result. The threshold references are:

- Percentage of throughput + vol. offset
- Percentage of (tank) capacity + vol. offset
- Percentage of deliveries + vol. offset
- Fixed value

### Test Type

Select the monitoring period for the selected test protocol.

- Monthly - The threshold is compared against the monthly variance summation over a calendar month. The test is performed monthly.
- Rolling - You define the number of rolling days. The threshold is compared to the variance summation over the defined number of days. The test is performed daily.
- Daily - The daily variance is compared to the threshold. The test is performed daily.

## **TLS-450 Setup and Operation Screens Manual**

- Rolling Consecutive - You define the number of rolling days. A test will pass when one of the daily variance thresholds is below the threshold set within the rolling period. For a test to fail, 'all' daily variance thresholds must exceed the threshold set for each day within the rolling period. The test is performed daily.

Allowable selections: Disabled, Monthly, Rolling, Daily, Rolling Consecutive  
Default: Monthly

### **Rolling Days**

If Test Type is not Rolling or Rolling Consecutive, Rolling Days is grayed out.

Allowable selections: 1 through 31  
Default: 31

### **% of Throughput**

This Alarm Threshold is the discrepancy between the total Meter Sales (throughput) and the Variance amount (Physical Inventory - Calculated Inventory).

Where: Calculated Inventory = Opening Volume + Delivery - Metered Sales + Manual Adjustment  
Physical Inventory = Fuel amount in the tank at the close of the day.

The system default is 1.00% of total meter sales (throughput) plus 130 gallons (492 litres) offset. In the U.S. the EPA has set this default as criteria not to be exceeded. Alarm Threshold must be between 0.00 and 9.99 percent.

Allowable selections: 0.00 to 9.99  
Default: 1.00

### **Vol. Offset**

Enter the offset amount to be added to the % of Throughput value that will trigger the Product Threshold Alarm.

Allowable selections: 0 to 264,172 gal. (0 to 999,999 Litres)  
Default: 130 gal. (492 Litres)

### **% of Capacity**

This Alarm Threshold is the discrepancy between the tank setup Full Capacity amount and the Variance amount (Physical Inventory - Calculated Inventory).

The system default is 1.00% of total Tank Full capacity plus 130 gallons (492 litres) offset. In the U.S. the EPA has set this default as a criteria not to be exceeded. Alarm Threshold must be between 0.00 and 9.99 percent.

Allowable selections: 0.00 to 9.99  
Default: 1.00

### **Vol. Offset**

Enter the offset amount to be added to the % of Capacity value that will trigger the Product Threshold Alarm.

Allowable selections: 0 to 264,172 gal. (0 to 999,999 Litres)  
Default: 130 gal. (492 Litres)



**% of Deliveries**

This Alarm Threshold is the discrepancy between the Fuel Delivery amount and the Variance amount (Physical Inventory - Calculated Inventory).

The system default is 1.00% of total Fuel Delivery plus 130 gallons (492 litres) offset. In the U.S. the EPA has set this default as a criteria not to be exceeded. Alarm Threshold must be between 0.00 and 9.99 percent.

Allowable selections: 0.00 to 9.99  
Default: 1.00

**Vol. Offset**

Enter the offset amount to be added to the % of Deliveries value that will trigger the Product Threshold Alarm.

Allowable selections: 0 to 264172 gal. (0 to 999,999 Litres)  
Default: 130 gal. (492 Litres)

**Fixed Value**

This Alarm Threshold is the discrepancy between the Fixed Value and the Variance amount (Physical Inventory - Calculated Inventory) without any offset.

Allowable selections: 0 to 264172 gal. (0 to 999,999 Litres)  
Default: 80 gal (302 litres)

## Comm

### Comm Setup - General

The Comm Devices area of Main Setup provides an interface to configure communication devices. The features ordered with your console will determine which communication devices are available. The selection of setup fields presented to the user for a particular Comm Device will depend on the type of communication device detected.

Cards that are pre-installed are auto-detected on boot of the operating system and pre-configured during startup of the TLS application. Once the application is running, you will see that the system has recognized the cards, configured the Comm screen fields (Slot, Port, and Device) setup, and initialized some settings with default values. Certain fields will be read-only and inaccessible to for changes. Other fields will be editable and the configuration can be changed. Each type of Comm Device will have a set of Tabs to organize its own specific setup parameters. For example, for an RS-232 Comm Device, the General tab will contain configuration and communication setup information, the Format tab will have date, time and unit information and the Advanced tab will have setup information for the advanced user.

The auto-detection feature can only detect the following Device Types; RS-232, RS-485, Internal Modem, Ethernet and USB. The mechanism cannot separately detect S-Sat or H-JBox Comm Devices. S-Sat and H-J Box Comm devices will be detected by the system as an RS-232 or Internal Modem device and you will have to select the specific device from a dropdown list in the TLS application.

### Console Comm Device Permissible Slots and Configurable Ports

---

To identify Comm Device ports, refer to the figure below:

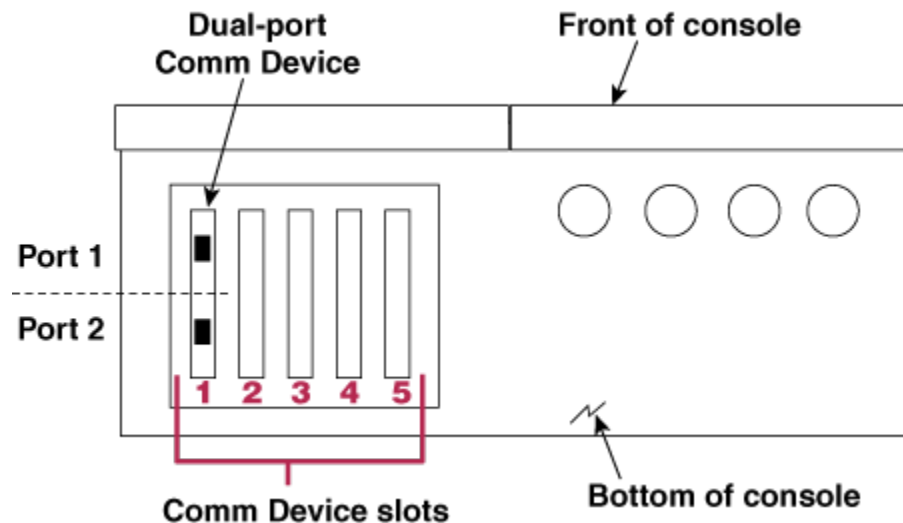

**TLS-450 Setup and Operation Screens Manual**

Refer to the two tables below to identify permissible slots and configurable ports for Comm Devices:

*C = Configurable, NC = Non-Configurable*

Comm Device	Comm Type	Slot 1		Slot 2	
		Port 1	Port 2	Port 1	Port 2
RS-232 Single Port (also EDIM, Satellite S-SAT and Satellite H-JBox apps.)	Serial	NC	C	NC	C
RS-232 Dual Port (also EDIM, Satellite S-SAT and Satellite H-JBox apps.)	Serial	C	C	C	C
RS-485 Single Port	Serial	NC	C	NC	C
RS-485 Dual Port	Serial	C	C	C	C
RS-232 / RS-485 Dual Port	Serial	C (RS-232)	C (RS-485)	C (RS-232)	C (RS-485)
SiteFax / Modem	Serial	NC	C	NC	C
CDIM	DIM	C	NC	C	NC

Comm Device	Comm Type	Slot 3		Slot 4		Slot 5	
		Port 1	Port 2	Port 1	Port 2	Port 1	Port 2
RS-232 Single Port (also EDIM, Satellite S-SAT and Satellite H-JBox apps.)	Serial	NC	C	---	---	---	---
RS-232 Dual Port (also EDIM, Satellite S-SAT and Satellite H-JBox apps.)	Serial	NC	C	C*	NC	---	---
RS-485 Single Port	Serial	NC	C	---	---	---	---
RS-485 Dual Port	Serial	NC	C	---	---	---	---
RS-232 / RS-485 Dual Port	Serial	NC	C (RS-485)	C*	NC	---	---
SiteFax / Modem	Serial	NC	C	---	---	---	---
Ethernet	TCPIP	---	---	NC	C	NC	C
Ethernet/ USB	TCPIP/ USB	---	---	NC	C (TCPIP)	C (USB)	C (TCPIP)
USB	USB	---	---	---	---	C	NC
CDIM	DIM	---	---	C**	NC	---	---

*\*Limited RS-232 availability (only RX, TX and Enable are active and this port is without full handshaking capability.*

*\*\*Slot 4 is preferred for CDIM.*

## **Comm Setup Procedure**

---

There are four Comm Device - General Setups within this topic. Touch the applicable link below to jump to the desired setup:

**[RS-232/RS-485, Internal Modem, Satellite Hughes H-JBox and Satellite S-Sat Comm Devices](#)**

**[Ethernet Devices](#)**

**[EDIM Devices](#)**

**[CDIM Devices](#)**

You can also refer to the [DIM Information Tables](#) in the References section for complete DIM string details.

## RS-232/RS-485, Internal Modem, Satellite Hughes H-JBox and Satellite S-Sat Comm Devices – General (page 1)

The General tab screen pages hold dropdowns to choose and enable this group of Comm Devices and to set up their communication properties.

### Configured

Allowable selections: Enabled, Disabled  
 Default: Disabled

### Slot

Allowable selections: List, None  
 Default: None

### Port

Some Comm Devices can have more than one port. If there is more than one port, you must select a port before selecting the valid Comm Device. If the Comm Device is auto-detected, this field is disabled.

Allowable selections: List, None  
 Default: None

## **Device**

### **Device**

The Auto detection mechanism may further restrict the Comm Device Type choices available to choose from in case a Device is already available in the slot.

If there is no Device in the slot, then all supported options for that specific slot will be available. Setting the Device to "None" will also set all the common fields and button icons along the bottom of screen to their default values thereby marking the entry as removed from the configured list of Comm Devices (a Save is always needed for the changes to take effect. A message warning will be shown to the user prior to the save).

Allowable selections: List, None  
Default: None

### **Label**

Enter a unique label for the Comm Device.

Allowable selections: Up to 20 alphanumeric characters  
Default: Comm Device Identifier and number

### **Baud Rate**

#### **(RS-232/RS-485, Modem Comm Devices)**

Allowable selections: 300,600, 1200, 2400, 4800, 9600, 19200, 38400, 57600, and 115200  
Default: RS-232 = 9600, RS-485 = 9600, Modem = 9600

#### **(H-JBOX, S-SAT Comm Devices)**

Allowable selections: 300,600, 1200, 2400, 4800, 9600, 19200, 38400, 57600, and 115200  
Default: 9600

### **Data Bits**

#### **(RS-232/RS-485, Modem Comm Devices)**

Allowable selections: 8 or 7  
Default: 7

#### **(H-JBOX, S-SAT Comm Devices)**

Allowable selections: 8 or 7  
Default: 8

### **Parity**

#### **(RS-232/RS-485, Modem Comm Devices)**

Allowable selections: None, Odd, Even  
Default: Odd

#### **(H-JBOX, S-SAT Comm Devices)**

Allowable selections: None, Odd, Even  
Default: None

### **Stop Bits**

#### **(RS-232/RS-485, Modem Comm Devices)**

Allowable selections: 1 or 2  
Default: 1

**(H-JBOX, S-SAT Comm Devices)**

Allowable selections: 1 or 2

Default: 1

**Satellite Connection String (Satellite H-JBox Comm Devices Only)**

Allowable selections: Alphanumeric, maximum 30 Characters

Default: Empty

**DTR state (Satellite S-SAT Comm Devices Only)**

Allowable selections: Normally High, Normally Low

Default: Normally High

**Ethernet Comm Devices – General (page 2)**

---

Setup changes for an Ethernet Comm Device may not be initially noticeable as these may take some time to take effect. If you remain on the screen long enough, the values will automatically be refreshed on the screen once the change has been completed. There will be no notice that the system is still working on the changes or that the request for changes has failed.

**Default Gateway**

***NOTE: Changing the Default Gateway will require a reboot of the console.***

- A system can only have one Ethernet Comm Device configured as the Default Gateway.
- The first Ethernet Comm Device that is configured (Enabled) will automatically be the Default Gateway (Yes). Subsequent Ethernet Comm Devices that are configured will not be Default Gateways (No).
- If an Ethernet Comm Device is the Default Gateway (Yes) and is subsequently de-configured (Disabled) or gets physically removed from the system, the system will no longer have a Default Gateway and gateway-dependent communication will be compromised. To regain gateway-dependent communication, another Ethernet Comm Device will need to be explicitly be set up as the Default Gateway (Yes).

**Setup - These rules only apply in a Multi-Ethernet Comm Device configuration**

- When an Ethernet Comm Device's IP Assignment is 'Dynamic', the Ethernet Comm Device will automatically be the Default Gateway (Yes). When an Ethernet Comm Device is set up as 'Dynamic', the Default Gateway field of the Ethernet Comm Device will automatically be set to 'Yes', the Default Gateway field of the rest of any other Ethernet Comm Devices will automatically be set to 'No', and the Default Gateway field will be read-only for all Devices. To set another Ethernet Comm Device as the Default Gateway (Yes), the user will have to first set the Ethernet Comm Device with the 'Dynamic' IP Assignment to 'Static' and then set the other Ethernet Comm Device as the Default Gateway (Yes).
- When all Ethernet Comm Devices' IP Assignment fields are 'Static' only one of them can be configured as the Default Gateway (Yes). That is, if one of the Ethernet Comm Devices becomes the Default Gateway (Yes), any other one that was the Default Gateway will automatically be set to 'No'. Also, if an Ethernet Comm Device that was the Default Gateway is set to 'No' then the lowest numbered Ethernet Comm Device will automatically be configured as the Default Gateway (set to Yes).

Allowable selections: Yes, No  
Default: Yes

### **Host Name**

**NOTE: Changing the Host Name will require a reboot of the console.**

A blank Host Name is not allowed.

Setup - These rules only apply in a multi-Ethernet Comm Device configuration. The Host Name of the Ethernet Comm Device that is the Default Gateway (Yes) will be used and can be changed.

Allowable selections: 1 to 100 characters  
Default: tls450

### **MAC Address**

This value is read only.

Format - The MAC Address will use the format of six groups of two hexadecimal digits separated by colons (:), e.g. 01:23:45:67:89:ab

### **IP Assignment**

**NOTE: Changing the IP Assignment will require a reboot of the console.**

In a multi-Ethernet Comm Device configuration, only one Ethernet Comm Device can be set up as 'Dynamic'. Once an Ethernet Comm Device is set up as 'Dynamic', the rest of the Ethernet Comm Devices will remain 'Static' and cannot be changed to 'Dynamic' from their own screens. To set another Ethernet Comm Device to 'Dynamic', the user will have to set the Ethernet Comm Device currently designated 'Dynamic' to 'Static' before making the change.

Allowable selection: Dynamic, Static. Default: Static

#### **NOTES:**

The terms Dynamic and Static are defined as they relate to an IP Assignment.

- Dynamic - When the IP Assignment is Dynamic, an Ethernet Comm Device can have a different IP address every time it connects to the network. This address is usually administered by a Network service such as DHCP (Dynamic Host Configuration Protocol).
- Static - When the IP Assignment is Static, an Ethernet Comm Device will have a permanent IP address every time it connects to the network. This address is entered by the console user.

### **IP Address**

**NOTE: Changing the IP Address will require a reboot of the console.**

Format - The format of this field will use the IPv4 dot-decimal notation, e.g. 192.0.2.235

Allowable selections: Numeric XXX.XXX.XXX.XXX (0 to 255 each field) . Default: 0.0.0.0



## **Ethernet Comm Devices – General (page 3)**

---

### **Subnet Mask**

**NOTE:** *Changing the Subnet Mask will require a reboot of the console.*

Format - The format of this field will use the IPv4 dot-decimal notation, e.g. 192.0.2.235

Allowable selections: Numeric XXX.XXX.XXX.XXX (0 to 255 each field). Default: 255.255.255.0

### **Gateway IP**

Format - The format of this field will use the IPv4 dot-decimal notation, e.g. 192.0.2.235

Allowable selections: Numeric XXX.XXX.XXX.XXX (0 to 255 each field). Default: 0.0.0.0

### **Primary DNS Server**

Format - The format of this field will use the IPv4 dot-decimal notation, e.g. 192.0.2.235

Allowable selections: Numeric XXX.XXX.XXX.XXX (0 to 255 each field)

Default: 0.0.0.0

### **Secondary DNS Server**

Format - The format of this field will use the IPv4 dot-decimal notation, e.g. 192.0.2.235

Allowable selections: Numeric XXX.XXX.XXX.XXX (0 to 255 each field). Default: 0.0.0.0

### **Serial Command Port**

In a multi-Ethernet Comm Device configuration, any changes this Field for one Ethernet Comm Device will not affect the same Field of the other Ethernet Comm Devices.

Allowable selections: Numeric 1 to 65535. Default: 10001

**NOTE:** For an Ethernet Comm Device, if you set up two or more of the Serial Command, SSH, HTTP or HTTPS Ports with the same number, communications may be compromised. No warning messages will be provided.

## **Ethernet Comm Devices – General (page 4)**

---

### **SSH Port**

In a multi-Ethernet Comm Device configuration, a change to this Field for one Ethernet Comm Device will be reflected in the same Field of the other Ethernet Comm Devices (will be made the same).

Allowable selections: Numeric 1 to 65535. Default: 22

**NOTE:** For an Ethernet Comm Device, if you set up two or more of the Serial Command, SSH, HTTP or HTTPS Ports with the same number, communications may be compromised. No warning messages will be provided.

**HTTP Port**

In a multi-Ethernet Comm Device configuration, a change to this Field for one Ethernet Comm Device will be reflected in the same Field of the other Ethernet Comm Devices (will be made the same).

Allowable selections: Numeric 1 to 65535. Default: 80

NOTE: For an Ethernet Comm Device, if you set up two or more of the Serial Command, SSH, HTTP or HTTPS Ports with the same number, communications may be compromised. No warning messages will be provided.

**HTTPS port**

In a multi-Ethernet Comm Device configuration, a change to this Field for one Ethernet Comm Device will be reflected in the same Field of the other Ethernet Comm Devices (will be made the same).

Allowable selections: Numeric 1 to 65535. Default: 443

NOTE: For an Ethernet Comm Device, if you set up two or more of the Serial Command, SSH, HTTP or HTTPS Ports with the same number, communications may be compromised. No warning messages will be provided.

## Comm Setup - Modem

This screen lets you enter device-specific parameters for the Modem Device.

### Dial Type

Allowable selections: Tone, Pulse  
 Default: Tone

### Dial-Tone Interval

Select a no dial tone alarm wait interval.  
 Allowable selections: 0001 to 9999 hours. Default: 32

### Answer On

Enter number of rings  
 Allowable selections: 0 to 9. Default: 1

### Dial In Configurable String

Allowable selection: Up to 100 alphanumeric character string. Default: Empty

### Dial Out Configurable String

Allowable selection: Up to 100 alphanumeric character string. Default: Empty

## EDIM Comm Devices – General (page 1)

11/30/2009 01:46 AM		All Functions Normal					
Comm Device Setup – General							Comm 1 :
General	DIM	Advanced	All Comms				
	Configured	Enabled					
	Slot	1					
	Port	1					
	Device	EDIM CARD					
	Label						
Comm 1	Comm 2	Comm 3	Comm 4	Comm 5	Comm 6	Comm 7	

### Configured

When the card is auto-detected, this field will be enabled but grayed out.

Allowable selections: Enabled, Disabled. Default: Disabled

### Slot

Read only when slot is detected, otherwise enter the configurable slot number (EDIMs 1,2,3 or 4)

Allowable selections: List, None  
Default: None

### Port

Some DIM Devices can have more than one port. If there is more than one port, you must select a port before selecting the valid DIM Device. If the DIM Device is auto-detected, this field is grayed out..

Allowable selections: List, None  
Default: None

### Device

The Auto detection mechanism may restrict the DIM Device Type choices available to choose from in case a Device is already available in the slot.

If there is no Device in the slot, then all supported options for that specific slot will be available. Setting the Device to "None" will also set all the common fields and button icons along the bottom of screen to their default values thereby marking the entry as removed from the configured list of DIM Devices (a Save is always needed for the changes to take effect. A message warning will be shown to the user prior to the save).

Allowable selections: List, None  
Default: None

**Label**

Enter a unique label for the DIM Device.

Allowable selections: Up to 20 alphanumeric characters  
Default: Comm Device Identifier and number

**EDIM Comm Devices – General (page 2)**

---

**DIM Protocol**

Touch the down arrow to the right of this field and enter the applicable DIM Protocol for your DIM card.

Allowable selections: See Table 1 below for valid options.  
Default: Unknown

**Baud Rate**

Touch the down arrow to the right of this field and enter the applicable Baud Rate for your DIM card.

Allowable selections: See Table 1 below for valid options.  
Default: Unknown

**Data Bits**

Touch the down arrow to the right of this field and enter the applicable number of Data Bits for your DIM card.

Allowable selections: See Table 1 below for valid options.  
Default: Unknown

**Parity**

Touch the down arrow to the right of this field and enter the applicable Parity for your DIM card.

Allowable selections: See Table 1 below for valid options.  
Default: Unknown

**Stop Bits**

Touch the down arrow to the right of this field and enter the applicable number of Stop Bits for your DIM card.

Allowable selections: See Table 1 below for valid options.

Default: Unknown

**Table 1. EDIMs Quick Reference Chart**

DIM P/N	Software Rev.	Protocol	Baud Rate (Default)	Parity (Default)	Data Bits (Default)	Stop Bits (Default)	Notes
330280-401	349643	GilbarcoEDIM (Gilbarco GSite)	1200	Even	7	1	1
330280-001	330273	VRProtocolDIM (BIR)	9600	Odd	7	1	1, 2

NOTES:

1. DIMs implemented for V402.
2. Metric is the default setting for unit conversion. Requires 'G' in parameter string for **gallon** units.

**EDIM References**

**EDIM Parameter String Chart**

Baud		Parity		Stop Bits		Data Bits		Conversion	
String	Rate	String	Type	String	Bits	String	Bits	String	Units
B9	9600	N	None	H	1	V	7	G	Gallons
B4	4800	E	Even	S	2	D	8	M	Metric
B2	2400	O	Odd	----	----	----	----	I	Imperial
B1	1200	----	----	----	----	----	----	----	----
B6	600	----	----	----	----	----	----	----	----
B3	300	----	----	----	----	----	----	----	----
BG	----	----	----	----	----	----	----	----	----

**EDIM Card - Female D Connector Pin Outs**

Pin	Function
2	Transmit Data
3	Receive Data
7	Signal Ground

## (EDIM) Comm Setup - DIM

11/30/2009 01:47 AM		All Functions Normal								
Comm Device Setup - DIM							Comm 1 :			
General	DIM	Advanced	All Comms							
Units Reported		METRIC								
Suppress Communication Alarm		No								
Comm 1	Comm 2	Comm 3	Comm 4	Comm 5	Comm 6	Comm 7				

This screen allows you to enter EDIM reporting parameters.

### Units Reported

Allowable selections: U.S., Metric, or Imperial  
Default: U.S.

### Suppress Communication Alarm

This selection is for V-R Protocol only.

Allowable selections: Yes or No  
Default: No

## CDIM Comm Devices – General (page 1)

11/30/2009 01:51 AM		All Functions Normal						
Comm Device Setup – General							Comm 5 :	
General		Advanced		All Comms				
Configured	Enabled							
Slot	4							
Port	1							
Device	CDIM CARD							
Label								

### Configured

When the card is auto-detected, this field will be enabled but grayed out.

Allowable selections: Enabled, Disabled

Default: Disabled

### Slot

Read only when slot is detected, otherwise enter the configurable slot number (CDIMs 1,2 or 4 [preferred]). Allowable selections: List, None. Default: None

### Port

Some DIM Devices can have more than one port. If there is more than one port, you must select a port before selecting the valid DIM Device. If the DIM Device is auto-detected, this field will be enabled but grayed out.

Allowable selections: List, None

Default: None



**Device**

The Auto detection mechanism may restrict the DIM Device Type choices available to choose from in case a Device is already available in the slot. If the DIM Device is auto-detected, this field will be enabled but grayed out.

If there is no Device in the slot, then all supported options for that specific slot will be available. Setting the Device to "None" will also set all the common fields and button icons along the bottom of screen to their default values thereby marking the entry as removed from the configured list of DIM Devices (a Save is always needed for the changes to take effect. A message warning will be shown to the user prior to the save).

Allowable selections: List, None  
Default: None

**Label**

Enter a unique label for the DIM Device.

Allowable selections: Up to 20 alphanumeric characters  
Default: Comm Device Identifier and number

**CDIM Comm Devices – General (page 2)**

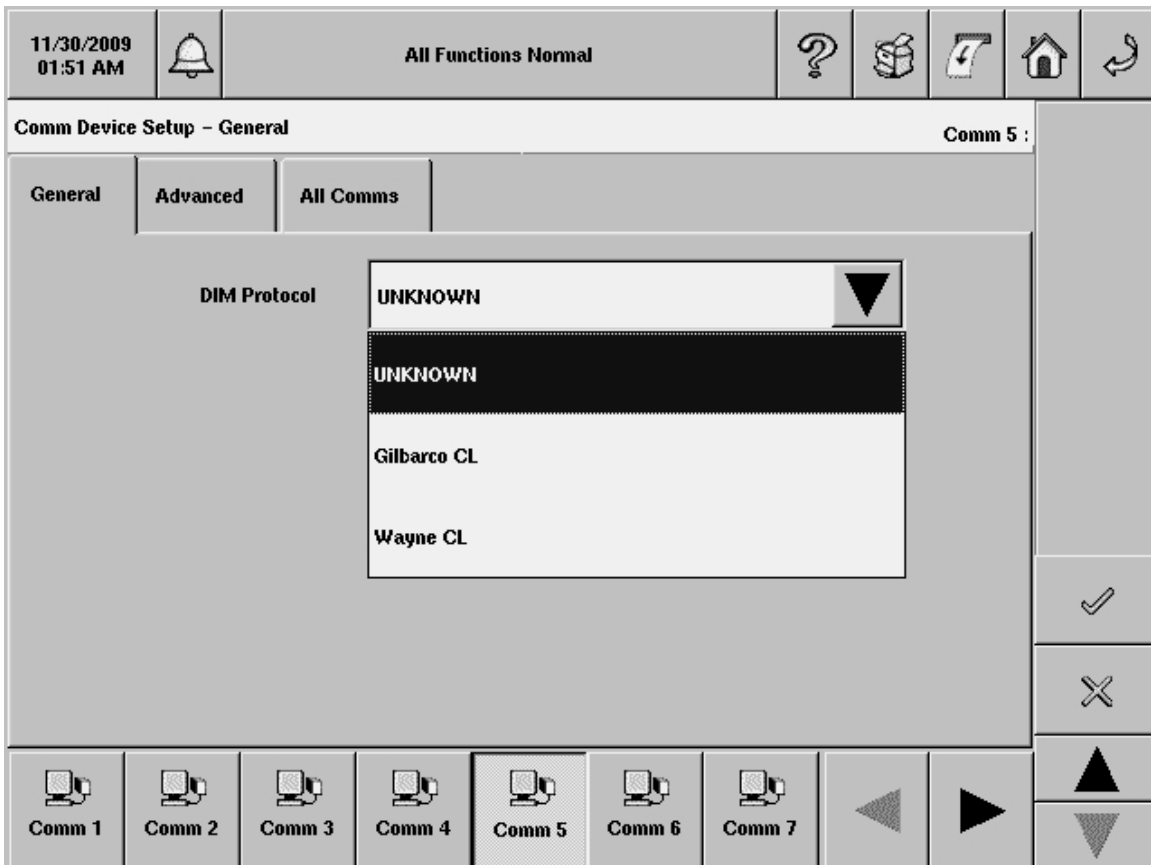

**DIM Protocol**

Touch the down arrow to the right of this field and enter the applicable DIM Protocol for your DIM card.

Allowable selections: Gilbarco CL, Wayne CL or Unknown  
Default: Unknown

**CDIM Quick Reference Chart**

DIM P/N	Software Rev.	Protocol	Baud Rate (Default)	Parity (Default)	Data Bits (Default)	Stop Bits (Default)	Notes	Pass Thru
330404-020	349634	Gilbarco CL	Proprietary				1, 2	NO
330404-010	349633	Wayne CL	Proprietary				1, 2	NO

**NOTES:**

1. Parameter string is never acquired.
2. DIMs implemented for V402.

## Comm Setup - Advanced

11/30/2009 01:51 AM		All Functions Normal					
Comm Device Setup - Advanced							Comm 5 :
General	Advanced	All Comms					
Comm Port Security	Disabled						
Security Code							
RS-232 End of Message	Disabled						
ETX Characters - Display							
ETX Characters - Computer							
Comm 1	Comm 2	Comm 3	Comm 4	Comm 5	Comm 6	Comm 7	

There are three Comm Device - Advanced Setups within this topic. Touch the applicable link below to jump to the desired setup:

- [RS-232/RS-485, Internal Modem, Satellite Hughes H-JBox, Satellite S-Sat and Ethernet Comm Devices - Advanced Tab Setups](#)
- [EDIM Advanced Tab Setups](#)
- [CDIM Advanced Tab Setups](#)

### RS-232/RS-485, Internal Modem, Satellite Hughes H-JBox, Satellite S-Sat and Ethernet Comm Devices - Advanced Tab Setups

#### Comm Port Security

Allowable selections: Enabled, Disabled  
Default: Disabled

### **Security Code**

A Case-sensitive code (Alpha and Enhanced Numeric (also punctuation characters), no spaces allowed and no control characters. Each character will be represented by an asterisk in the field.

Allowable selections: A six-character alpha-numeric string  
Default: Blank

### **RS-232 End of Message**

When this field is disabled, the 2 following fields (ETX Characters - Display and ETX Characters - Computer) will be disabled. When this field is set to 'Enabled', both fields will become enabled and the keypad will be accessible. You will be allowed to enter 1 or 2 ASCII characters for both the RS-232 Display and Computer Formats.

Allowable selections: Disabled, Enabled  
Default: Disabled

### **ETX Characters - Display**

Accepts non-printable characters through the GUI. Enter hex value as string with an opening and closing bracket. Convert text string to char value and save or show. Example: Enter [0x06][0x15]

Allowable selections: 1 or 2 alpha-numeric characters (ASCII value 0 to 255)  
Default: Blank

### **ETX Characters - Computer**

Accepts non-printable characters through the GUI. Enter hex value as string with an opening and closing bracket. Convert text string to char value and save or show. Example: Enter [0x06][0x15]

Allowable selections: 1 or 2 alpha-numeric characters (ASCII value 0 to 255)  
Default: Blank

## **EDIM Advanced Tab Setups**

---

### **Comm Port Security**

This selection is only for DIMs that support pass-through - See Table 1 in [Comm Setup - General](#) topic. This entry does not apply to CDIMs and will be grayed out for DIMs that do not support pass-through.

Allowable selections: Enabled, Disabled  
Default: Disabled

### **Security Code**

This selection is only for DIMs that support pass-through - See Table 1 in [Comm Setup - General](#) topic. When the DIM is used in pass-through mode it does not pass DIM data. This field will be grayed out for DIMs that do not support pass-through.

A case-sensitive code (Alpha and Enhanced Numeric (also punctuation characters), no spaces allowed and no control characters. Each character will be represented by an asterisk in the field.

Allowable selections: A six-character alpha-numeric string  
Default: Blank

### **RS-232 End of Message**

When this field is disabled, the 2 following fields (ETX Characters - Display and ETX Characters - Computer) will be disabled. When this field is set to 'Enabled', both fields will become enabled and the keypad will be accessible. You will be allowed to enter 1 or 2 ASCII characters for both the RS-232 Display and Computer Formats.

Allowable selections: Disabled, Enabled  
Default: Disabled

### **ETX Characters - Display**

Accepts non-printable characters through the GUI. Enter hex value as string with an opening and closing bracket. Convert text string to char value and save or show. Example: Enter [0x06][0x15]

Allowable selections: 1 or 2 alpha-numeric characters (ASCII value 0 to 255)  
Default: Blank

### **ETX Characters - Computer**

Accepts non-printable characters through the GUI. Enter hex value as string with an opening and closing bracket. Convert text string to char value and save or show. Example: Enter [0x06][0x15]

Allowable selections: 1 or 2 alpha-numeric characters (ASCII value 0 to 255)  
Default: Blank

## **CDIM Advanced Tab Setups (page 1)**

---

### **Comm Port Security**

This entry does not apply to CDIMs.

Allowable selections: Enabled, Disabled  
Default: Disabled

### **Security Code**

This selection is only for DIMs that support pass-through - See Table 1 in [Comm Setup - General](#) topic. When the DIM is used in pass-through mode it does not pass DIM data. This field will be grayed out for DIMs that do not support pass-through.

A case-sensitive code (Alpha and Enhanced Numeric (also punctuation characters), no spaces allowed and no control characters. Each character will be represented by an asterisk in the field.

Allowable selections: A six-character alpha-numeric string  
Default: Blank

### **RS-232 End of Message**

When this field is disabled, the 2 following fields (ETX Characters - Display and ETX Characters - Computer) will be disabled. When this field is set to 'Enabled', both fields will become enabled and the keypad will be accessible. You will be allowed to enter 1 or 2 ASCII characters for both the RS-232 Display and Computer Formats.

Allowable selections: Disabled, Enabled  
Default: Disabled

**ETX Characters - Display**

Accepts non-printable characters through the GUI. Enter hex value as string with an opening and closing bracket. Convert text string to char value and save or show. Example: Enter [0x06][0x15]

Allowable selections: 1 or 2 alpha-numeric characters (ASCII value 0 to 255)  
Default: Blank

**ETX Characters - Computer**

Accepts non-printable characters through the GUI. Enter hex value as string with an opening and closing bracket. Convert text string to char value and save or show. Example: Enter [0x06][0x15]

Allowable selections: 1 or 2 alpha-numeric characters (ASCII value 0 to 255)  
Default: Blank

**CDIM Advanced Tab Setups (page 2)**

---

**DIM Parameter String**

Enter the desired parameter string for this DIM.

Allowable selections: Enter proprietary string. For additional string components, see Table below.  
Default: Blank

**DIM Parameter String Entries**

<b>Protocol</b>	<b>String</b>	<b>Description</b>
Gilbarco CL	T	Do not collect cumulative totals
	R	Send captured message to TLS (engineering use only)
	W	Transaction field precision is hundredths (thousandths default)
	C	Cumulative field precision is hundredths (thousandths default)
Wayne CL	R	Send protocol to TLS (engineering use only)
V-R Protocol	J	Suppress Communication Alarm

## Comm Setup - All Comms

11/30/2009 01:48 AM		All Functions Normal					
Comm Device Setup - All Comms						All Comms	
General	DIM	Advanced	All Comms				
Euro Protocol Prefix	S						
H-Protocol Data Format	HEIGHT						

This screen allows you to assign Euro Protocol prefixes and formats to RS-232 and EDIM messages.

### Euro Protocol Prefix - International Option

This feature is for European applications only.

Allowable selections: S (standard Euro Protocol prefix) or d (special Euro Protocol prefix)

Default: S

### H-Protocol Data Format - International Option

This feature is available only if there is an RS-232 or modem module installed in the console and H-protocol is used. This option allows either Tank Height or Tank Volume data for H-protocol. On power up, this feature will default to HEIGHT for backward compatibility. Accept the default if you are not using H-protocol.

Allowable selections: Height or Volume

Default: Volume

## Automatic Events

### Automatic Events Setup - Address Book

08/29/2008 11:40 AM		Ae 2: SETUP DATA WARNING				
Automatic Events - Address Book #1						More
Device Tasks		Print Tasks	Auto Connect Tasks	Address Book		
Contact ID	Contact Name	E-Mail Address	Modem Number	Fax Number.....		
1	Service Manager			800-555-1234		
						Edit Entry
						Delete Entry

The Automatic Events Setup - Address Book screen contains a record of your list of contact names and their outbound connectivity details.

#### Report Column Descriptions

##### Contact ID

This column shows the assigned numeric identifier for each contact you have set up (1 - 25).

##### Contact

This column lists the name of the contact entry (30 characters max.).

##### Modem Number

This column lists the computer modem phone number of the Contact Entry. If a Contact needs a Modem Computer transmission, then this column contains the Remote Modem Number, otherwise the field is empty.



**Fax Number**

This column lists the Fax modem phone number of the Contact Entry. If a Contact needs a Fax transmission, then this column contains the Fax number, otherwise the field is empty.

**Remote Host Address and Port**

This column lists the remote host TCP/IP address and port of the Contact Entry . If a Contact needs a TCP/IP computer transmission, then this column contains the remote host TCP/IP address and port, otherwise the field is empty.

**Satellite/Connect**

This column lists the Satellite Connect string of the Contact Entry. If a Contact needs a Satellite transmission, then this column contains the Satellite Connect String, otherwise the field is empty.

**E-Mail Address**

This column lists the E-Mail Address of the Contact Entry. If a Contact needs E-Mail messaging capabilities then this column contains the E-Mail address, otherwise the field is empty.

**Control Buttons (on right of screen)**

---

**Add Entry**

Touch this button to add a new contact (the maximum number of Contacts that can be entered is 25) After the maximum number of allowed Contacts is reached, touching the Add Entry button will display an error message indicating that a contact must be deleted before another can be added.

**Edit Entry**

You select a Contact entry and then touch this button to edit the contact's information.

**Delete Entry**

You select the entire Contact entry and then touch this button to delete the Contact.

## Add/Edit Contact Entry - Contacts

The Add/Edit Contact Entry screen lets you add a contact to the address book or edit an entry if you selected a contact in the address book.

### Contact Name

Add a new contact or edit the displayed contact.

Allowable selection: Up to 30 alphanumeric characters.

Default selection: empty

### Control Buttons (lower right of screen)

#### Save

If editing a contact, touch this button to save the current record entries to the database. It will not clear the screen. If adding a contact, touch this button to save the new entry's record to the database ready for a new add.

#### Cancel

If editing a contact, touch this button to cancel all non-saved entries and revert back to original values. If adding a contact, touch this button to clear the field, without saving, ready for a new add.

## Add/Edit Contact Entry - Modem

08/29/2008 11:43 AM		Ae 2: SETUP DATA WARNING		?		📦		↶		🏠		↷	
Add Contact Entry - Modem											Station Owner		
★ Contacts		Modem		Fax		TCP / IP		Satellite		E-Mail			
Modem # (Computer)		<input type="text"/>						🔍					
Modem COM Port		Co 4:						▼					
Dial-Out String		<input type="text"/>						🔍					
Number of Retries		3						🔍		✓			
Retry Delay Time		3						🔍		✗			
											▲		
											▼		

The Add Contact Entry - Modem screen lets you add/edit communication parameters for modem outbound connectivity for the current contact. This connection method is available if a modem is installed in the console.

### Modem # (Computer)

Enter the phone number of the outbound computer's modem.

Allowable selection: Modem numeric string, maximum 40 characters

Default selection: empty

### Modem COM Port

This field allows the Modem assignment to the current contact. The setup of a modem will be done in the Comm Devices Setup area. Select the console modem used to attempt the connection.

Allowable selections: Available Modem Comm Devices

Default selection: First modem on list (if available, otherwise, empty)

### Dial-Out String

Enter the alternate dial-out string that overrides the one given in Comm Devices Setup for that specific modem.

Allowable selections: Alphanumeric string, maximum 50 characters. Default selection: Empty

**Number of Retries**

Allowable selection: Numeric, 3 to 99  
Default: 3

**Retry Delay Time**

Allowable selection: Numeric, 1 to 99 minutes  
Default: 3

**Control Buttons (lower right of screen)**

---

**Save**

If editing a contact's modem information, touch this button to save the current record entries to the database. It will not clear the screen. If adding a contact's modem information, touch this button to save the new entry's record to the database and clear the screen, ready for a new add.

**Cancel**

If editing a contact's modem information, touch this button to cancel all non-saved entries and revert back to original values. If adding a contact's modem information, touch this button to clear the field, without saving, ready for a new add.

## Add/Edit Contact Entry - Fax

11/07/2008 08:45 AM				All Functions Normal											
Add Contact Entry - Fax													station		
★ Contacts		Modem		Fax		TCP / IP		Satellite		E-Mail					
Fax Number		<input type="text"/>													
Fax Modem COM Port		<input type="text"/>													
Dial-Out String		<input type="text"/>													
Number of Retries		3		<input type="text"/>											
Retry Delay Time		3		<input type="text"/>											

The Add Contact Entry - Fax screen lets you add/edit communication parameters for fax outbound connectivity for the current contact.

This connection method is available if a fax modem card is installed in the console.

### Fax Number

Enter the phone number of the contact's fax machine.

Allowable selection: 40 character maximum

Default selection: Empty

### Fax Modem COM Port

Select the fax modem comm device assignment for the contact.

Allowable selection: First fax modem on dropdown list (if available, otherwise, Empty)

### Dial-Out String

Allowable selection: AlphaNumeric, maximum 50 characters

Default selection: Empty

**Number of Retries**

Allowable selection: Numeric, 3 to 99

Default: 3

**Retry Delay Time**

Allowable selection: Numeric, 1 to 99 minutes

Default: 3

**Control Buttons (lower right of screen)**

---

**Save**

If editing a contact's fax information, touch this button to save the current record entries to the database. It will not clear the screen. If adding a contact's fax information, touch this button to save the new entry's record to the database and clear the screen, ready for a new add.

**Cancel**

If editing a contact's fax information, touch this button to cancel all non-saved entries and revert back to original values. If adding a contact's fax information, touch this button to clear the field, without saving, ready for a new add.

## Add/Edit Contact Entry - TCP/IP

08/29/2008 11:43 AM		Cn 1: SETUP DATA WARNING		?		📦		↶		🏠		↷	
Add Contact Entry - TCP / IP										Station Owner			
★ Contacts		Modem		Fax		TCP / IP		Satellite		E-Mail			
Remote TCP / IP Address		0.0.0.0						🔍					
Remote TCP / IP Port		20001						🔍					
Local TCP / IP		Co 1:						▼					
Number of Retries		3						🔍		✓			
Retry Delay Time		3						🔍		✗			
												▲	
												▼	

The Add Contact Entry - TCP/IP screen lets you add/edit communication parameters for TCP/IP outbound connectivity for the current contact.

This connection method is available if an Ethernet Comm Device is installed in the console.

### Remote TCP/IP Address

Enter the remote host's TCP/IP address.

Allowable selection: IP Address Formatted XXX.XXX.XXX.XXX, where XXX is 0 to 255, OR also a server address such as 'myServer.bigg.com'.

Default selection: 0.0.0.0

### Remote TCP/IP Port

Enter the remote host's TCP/IP port.

Allowable selection: 0 to 65535

Default selection: 20001

### Local TCP/IP

Enter the local TCP/IP assignment for the current contact.

## **TLS-450 Setup and Operation Screens Manual**

Allowable selections: Available Ethernet Comm Devices.

Default selection: First Ethernet Comm Device on List (if available, otherwise, Empty)

### **Num of Retries**

Allowable selection: Numeric, 3 to 99

Default: 3

### **Retry Delay Time**

Allowable selection: Numeric, 1 to 99 minutes

Default: 3

## **Control Buttons (lower right of screen)**

---

### **Save**

If editing a contact's TCP/IP information, touch this button to save the current record entries to the database. It will not clear the screen. If adding a contact's TCP/IP information, touch this button to save the new entry's record to the database and clear the screen, ready for a new add.

### **Cancel**

If editing a contact's TCP/IP information, touch this button to cancel all non-saved entries and revert back to original values. If adding a contact's TCP/IP information, touch this button to clear the field, without saving, ready for a new add.



## Add/Edit Contact Entry - Satellite

08/29/2008 11:43 AM		Ae 2: SETUP DATA WARNING		?		📦		↶		🏠		↷	
Add Contact Entry - Satellite										Station Owner			
* Contacts		Modem		Fax		TCP / IP		Satellite		E-Mail			
Satellite Conn. String		<input type="text"/>						🔍					
Satellite COM Port		<input type="text"/>						▼					
Number of Retries		3						🔍					
Retry Delay Time		3						🔍					
										✓			
										✕			
										▲			
										▼			

The Add Contact Entry - Satellite screen lets you add/edit communication parameters for satellite outbound connectivity for the current contact.

This connection method is available if a satellite Comm Device is installed in the console.

### Satellite Conn. String

Enter the current contact's Satellite connection string.

Allowable selection: Alpha-Numeric, maximum 30 characters

Default selection: Empty

### Satellite COM Port

Select the Satellite assignment for the current contact.

Allowable selection: Available Satellite Comm Devices

Default selection: First Satellite on list (if available, otherwise, empty)

### Number of Retries

Allowable selection: Numeric, 3 to 99

Default: 3

**Retry Delay Time**

Allowable selection: Numeric, 1 to 99 minutes  
Default: 3

**Control Buttons (lower right of screen)**

---

**Save**

If editing a contact's Satellite information, touch this button to save the current record entries to the database. It will not clear the screen. If adding a contact's Satellite information, touch this button to save the new entry's record to the database and clear the screen, ready for a new add.

**Cancel**

If editing a contact's Satellite information, touch this button to cancel all non-saved entries and revert back to original values. If adding a contact's Satellite information, touch this button to clear the field, without saving, ready for a new add.

## Add/Edit Contact Entry - Email

The Add Contact Entry - Email screen lets you add/edit communication parameters for e-mail outbound connectivity for the current contact.

This connection method is available if an e-mail feature is installed in the console.

### E-Mail Address

Enter the current contact's electronic mail (e-mail) address.

Allowable selection: AlphaNumeric, maximum 50 characters. Default selection: Empty

### Control Buttons (lower right of screen)

#### Save

If editing a contact's email information, touch this button to save the current record entries to the database. It will not clear the screen. If adding a contact's email information, touch this button to save the new entry's record to the database and clear the screen, ready for a new add.

#### Cancel

If editing a contact's email information, touch this button to cancel all non-saved entries and revert back to original values. If adding a contact's fax information, touch this button to clear the field, without saving, ready for a new add.

## Automatic Events Setup - Task Log

11/07/2007 09:02 AM		T 1: SETUP DATA WARNING				
Automatic Events - Task Log #1						More
Print Tasks	Auto Connect Tasks	Address Book	Task Log			Remove Entry
Report/Action	Contact	Date and Time	Retries	Device/Connection Mode	Status...	Clear This Log
						Select

The Automatic Events Setup - Task Log screen contains a History (Log) listing the results of assigned Automatic Event Activities that have occurred.

### Report Column Descriptions

**Event Time**

This column shows the date and time when the task is triggered.

**Event ID**

This column shows the assigned numeric identifier for each event you have set up (1 to 30).

**Report/Action**

Name of Report Transmitted or Action to perform.

**Contact**

Contact Name (for Auto Connect or Report data).

### **Last Attempt Time**

The date and time when the Task was last attempted.

### **Attempts**

The number of Task Attempts. Note: Each retry attempt is not added to the log. Instead, both the retry count of the existing record and the date and time are updated.

Value range: 1 to 99

### **Device/Connection Mode**

Device Label that is involved in performing the function (e.g., Relay 1). When a Contact is involved in the Automatic Action it represents the Device used and Format of the Data to be transmitted.

### **Status**

The status of the Auto Connect Transaction.

### **Status Message**

None or a description of an error.

## **Control Buttons (on right of screen)**

---

### **Remove Entry**

You select a Task Record entry and then touch this button to remove the selected log entry.

### **Clear This Log**

Clears the items in the Tasks Log as selected by the Current Filter.

### **Select**

This function is presented as a Dialog in which you can choose from a variety of filtering options. These filtering options let you select automatic event records from All Tasks, Device Tasks, Print Tasks and Auto Connect tasks. They are also used to select Task Log records:

- **Select Report/Action** - Allowable selections: All Reports and Actions (including Auto Connect), All Reports, All Actions or Specific Reports and Actions in the Log selections as in 'Select Action' and 'Select Report' above. Default selection: All Reports and Actions
- **Select Contact** - Allowable selections: All Contacts or single select for specific contacts that show up on the List of the Currently Selected Tab. Default selection: All Contacts and Devices
- **Select Time Interval** - Allowable selections: Unrestricted (a specific time frame will not be part of the filter), Current Day, Current Week, Current Month, Current Year. Default selection: Unrestricted
- **Select Device/Connection Mode** - Allowable selections: All Connection Modes, Computer, Fax, EMail, SMS. Default selection: All Connection Modes
- **Select Status** - Allowable selections: Any Status, Successful, Pending, Failed. Default selection: Any Status

## Automatic Events Setup - All Tasks

11/07/2008 09:03 AM		All Functions Normal							
Automatic Events - All Tasks #1								All Tasks	
All Tasks	Device Tasks	Print Tasks	Auto Connect Tasks	Add Bo			More		
Event ID	Time/Event	Report/Action	Contact	Device/Connection Mode.....		Add Task			
						Edit Task			
						Delete Task			

The Automatic Events Setup - All Tasks screen shows a report-like description of all Automatic Tasks (Device, Print and Auto Connect) you have set up.

Individual Tasks can involve many combinations of Reports or Actions, Times, Events, Contacts and Connection Modes. Any record containing more selections than can fit in the column's width will have an ellipsis inside a parenthesis '(...)' towards the edge of the column. If you want to find out more details on such a record you will have to touch the 'Edit Task' button to view the devices/actions assigned to that task.

Each row (task) in the All Tasks list is selectable. The control buttons on the right of the screen let you add a new task, edit a selected task in the report, delete a selected task in the report or modify (filter) the contents of the report.

### Report Column Descriptions

#### Event ID

This column shows the assigned numeric identifier for each event you have set up (1 - 30).

#### Time/Event

This column lists the Time or Event that triggers the device-related task (e.g., Daily at 3:00 PM ).

**Report/Action**

This column describes the Action to be performed (e.g., Outbound Connection).

**Contact**

This column describes the organization/person to be contacted (e.g., ABC Mgmt.).

**Device/Connection Mode**

This column lists the Device Label that is involved in performing the function. When a Contact is involved in the Automatic Action, it represents the Device used and Format of the Data to be transmitted (e.g., Computer - TCP/IP).

**Control Buttons (on right of screen)**

---

**Add Task**

Touch this button to add a new task.

**Edit Task**

You select a Task Record entry and then touch this button to edit the task.

**Delete Task**

You select a Task Record entry and then touch this button to delete the task.

## Automatic Events Setup - Device Tasks

11/07/2008 09:03 AM		All Functions Normal					
<b>Automatic Events - Device Tasks</b>						All Device Tasks	Add Task
All Tasks	Device Tasks	Print Tasks	Auto Connect Tasks	Add Bo	◀ ▶	Edit Task	
Event ID	Time/ Event	Action	Device/ Connection Mode	Delete Task			
						▲	▼

The Automatic Events Setup - Device Tasks screen shows a report-like description of Automatic Events you have set up. The control buttons on the right of the screen let you add a new Device task, edit a selected Device task in the report, delete a selected Device task in the report or modify (filter) the contents of the report.

Individual Tasks can involve many combinations of Reports or Actions, Times, Events, Contacts and Connection Modes. Any record containing more selections than can fit in the column's width will have an ellipsis inside a parenthesis '(...)' towards the edge of the column. If you want to find out more details on such a record you will have to touch the 'Edit Task' button to view the devices/actions assigned to that task.

### Report Column Descriptions

---

**Event ID**

This column shows the assigned numeric identifier for each event you have set up (1 - 30).

**Time Event**

This column lists the Time or Event that triggers the device-related task (e.g., Sudden Loss Alarm: T1: REGULAR).



**Action**

This column describes the Action to be performed (e.g., Relay Off).

**Device/Connection Mode**

This column lists the Label of the Device (e.g., Relay 1) that is involved in performing the function.

**Control Buttons (on right of screen)**

---

**Add Task**

Touch this button to add a new Device task.

**Edit Task**

You select a Task Record entry and then touch this button to edit the task.

**Delete Task**

You select a Task Record entry and then touch this button to delete the task.

**View Data**

The View Data button will only be present only if data does not fit horizontally within a column. Touching this button will display a scroll bar which you then touch to scroll through the column's contents.

## Automatic Events - Add Tasks - Device

The Automatic Events - Add Tasks - Device screen for Add or Edit a Task displays selections to control a Device Automatically.

### Event (Field)

Devices have NO controllable action. The action is determined by their setup. That is, if a relay is 'normally open' and the event happens the relay will change to closed. When the event clears, the relay will go back to open (its normal state as per setup).

Touch this button to the select the event(s) from the drop-down list that will trigger the new task:

- Alarms
- External Inputs

Note: Notifications cannot be assigned for 'Device' action tasks. Default: Field is empty.

### Device (Field)

Select the specific device from the drop-down list of available relays, pumps, lines. Only 1 device can be selected per event. Default: First device in the list.

## Automatic Events Setup - Print Tasks

11/07/2008 09:04 AM		All Functions Normal							
Automatic Events - Print Tasks								All Print Tasks	Add Task
All Tasks	Device Tasks	Print Tasks	Auto Connect Tasks	Add Bo					
Event ID	Time/Event	Report	Printer					Edit Task	Delete Task

The Automatic Events Setup - Print Tasks screen shows a report-like description of printer related automatic activities you have set up. The control buttons on the right of the screen let you add a new Print task, edit a selected Print task in the report, delete a selected Print task in the report or modify (filter) the contents of the report.

Individual Tasks can involve many combinations of Reports or Actions, Times, Events, Contacts and Connection Modes. Any record containing more selections than can fit in the column's width will have an ellipsis inside a parenthesis '(...)' towards the edge of the column. If you want to find out more details on such a record you will have to touch the 'Edit Task' button to view the devices/actions assigned to that task.

### Report Column Descriptions

#### Event ID

This column shows the assigned numeric identifier for each event you have set up (1 - 30).

#### Time Event

This column lists the Time or Event that triggers the automatic printer-related task (e.g., Delivery End: T 1).

**Report**

This column describes the Name of Report to be printed (e.g., Delivery Report).

**Printer**

This column lists the Printer Device Label that is involved in printing (e.g., Front Desk Printer).

**Control Buttons (on right of screen)**

---

**Add Task**

Touch this button to add a new print task.

**Edit Task**

You select a Task Record entry and then touch this button to edit the task.

**Delete Task**

You select a Task Record entry and then touch this button to delete the task.

**View Data**

The View Data button will only be present only if data does not fit horizontally within a column. Touching this button will display a scroll bar which you then touch to scroll through the column's contents.

## Automatic Events Add Tasks - Print

The Automatic Events Add Tasks - Print screen for Add or Edit a Task displays selections to Print Automatically.



### Time (Field)

This dialog provides drop-down lists to select a time frequency for the new print task:

- **Period** - Allowable selections: Annually by Day of Week, Annually by Day of Month, Monthly by Day of Week, Monthly by Day of Month, Weekly, Daily. Default selection: Weekly
- **Month** - Allowable selections: January – December. Default selection: January
- **Week Number** - Allowable selections: 1 - 6, Last Week. Default selection: 1
- **Day of Week** - Allowable selections: Sunday – Saturday. Default selection: Sunday
- **Day of Month** - Allowable selections: 1 – 31. Default selection: 1
- **Time of Day** - Allowable selections: Time in Hours and Minutes, 24 Hr sensitive. Default selection: 12:00 AM

Default: Field is empty.



**Event (Field)**

Touch this button to select the event(s) from the drop-down lists that will trigger the new task:

- Alarms
- Notifications
- External Inputs

Default: Field is empty.

**Printer (Field)**

Select a Printer from the dropdown list of available printers.

Default: Internal printer.

**Report (Field)**

Select Report(s) to be printed from multi-select dropdown box.

Default: Field is empty.

## Automatic Events Setup – Auto Connect Tasks

11/07/2008 09:07 AM		All Functions Normal					
Automatic Events – Auto Connect Tasks					All Auto Connect Tasks		Add Task
All Tasks	Device Tasks	Print Tasks	Auto Connect Tasks	Add Bo			Edit Task
Event ID	Time/Event	Report/Action	Contact	Connection Mode			Delete Task

The Automatic Events Setup - Auto Connect Tasks screen shows a report-like description of Auto-Connect-Related automatic activities you have set up. The control buttons on the right of the screen let you add a new task, edit a selected task in the report, delete a selected task in the report or modify (filter) the contents of the report.

Individual Tasks can involve many combinations of Reports or Actions, Times, Events, Contacts and Connection Modes. Any record containing more selections than can fit in the column's width will have an ellipsis inside a parenthesis '(...)' towards the edge of the column. If you want to find out more details on such a record you will have to touch the 'Edit Task' button to view the devices/actions assigned to that task.

NOTE: The number of auto-connect tasks is limited to 30. After the maximum number of allowed auto connect tasks is reached, pressing the Add Task button will display an error message indicating that a task must be deleted before another can be added.

### Report Column Descriptions

#### Event ID

This column shows the assigned numeric identifier for each event you have set up (1 - 30).

**Time/Event**

This column lists the timed or event action that triggers the automatic event to be executed (e.g., Weekly on Monday at 6:00 AM).

**Report/Action**

This column describes the name of report transmitted or action to be performed (e.g., Inventory Report).

**Contact**

This column lists the contact name (for auto-connect or report data) (e.g., Service Manager).

**Connection Mode**

This column lists the device used and format of the data to be transmitted (Co 1: Modem 1 Label).

**Control Buttons (on right of screen)**

---

**Add Task**

Touch this button to add a new task.

**Edit Task**

You select a Task Record entry and then touch this button to edit the task.

**Delete Task**

You select a Task Record entry and then touch this button to delete the task.

**View Data**

The View Data button will only be present only if data does not fit horizontally within a column. Touching this button will display a scroll bar which you then touch to scroll through the column's contents.



## Automatic Events - Add Tasks - Auto Connect

The Automatic Events- Add Tasks-Auto Connect screen lets you add a task to auto connect in computer mode or non-computer mode. Make selections from the entry fields below as required.

If the maximum number of allowed Auto-Connect Tasks is reached on a save, all fields within the Auto Connect Tab will be shown as disabled. The number of auto-connect tasks is limited to 30. After the maximum number of allowed auto-connect tasks is reached, pressing the Add Task button will display an error message indicating that a task must be deleted before another can be added.



### Time (Field)

Touch this button to select a time frequency for the new task.

- **Period** - Allowable selections: Annually by Day of Week, Annually by Day of Month, Monthly by Day of Week, Monthly by Day of Month, Weekly, Daily. Default selection: Weekly
- **Month** - Allowable selections: January – December. Default selection: January
- **Week Day** - Allowable selections: Sunday – Saturday. Default selection: Sunday
- **Occurrence** - Allowable selections: 1st, 2nd, 3rd, 4th, Last. Default selection: 1st
- **Day of Month** - Allowable selections: 1 – 31. Default selection: 1
- **Time of Day** - Allowable selections: Time in Hours and Minutes, 24 Hr sensitive. Default selection: 12:00 AM

Default: Field is empty.



**Event (Field)**

Touch this button to select the event(s) from the dropdown lists that will trigger the new task:

- Alarms
- Notifications (Notifications cannot be assigned for 'Device' action tasks)
- External Inputs

**Connection Mode (Field)**

Select an auto-connect method.

Possible selections: Computer mode auto-connect methods: Modem, TCP/IP or Satellite. Non-computer-mode auto-connect methods: Fax or E-Mail.

Default: Modem

**Report (Field) - Non-Computer Mode Only**

Select the report(s) to be issued.

Possible selections: Any report in the dropdown box

Default: Empty

**Contact (Field)**











Select a specific contact. Contact Selections will depend on whether they support the selected auto-connect method.

Possible selection: Specific contact from the Address Book

Default: First Address Book Entry

## Meter

### Meter Setup

03/03/2010 12:35 PM		T 1: SETUP DATA WARNING					
<b>Meter Setup</b>							
TC Meters <input type="text" value=""/>							
							
							
							
							

This screen allows you apply temperature compensation corrections to volume amounts received from the site's dispenser meters.

#### TC Meters

This feature allows you to choose whether or not to calculate Business Inventory Reconciliation (BIR) volumes using the Temperature Compensation (TC) value. Select No (the default) if the meters are not temperature compensated. Select Yes if the meters are temperature compensated (the calculation of all BIR volumes will be based on the programmed TC value).

Allowable selections: Yes or No  
Default: No

## Printer Setup - Setup

### Printer Setup Screen 1

08/03/2011 11:26 AM				Ae 3: SETUP DATA WARNING											
Printer Setup - Setup										PRINTER 1 : TLSIntegralPrinter		Get Printers			
Setup		Status		Jobs											
Configured		Enabled													
Printer		APS_CP324HRS_640_USB_1													
Is Default		Yes													
Label		TLSIntegralPrinter													
URI		aps:/dev/usb/lp0?type=usb													
PRINTER 1 (Default)		PRINTER 2		PRINTER 3		PRINTER 4		PRINTER 5							

This screen can configure printers connected locally to the USB port, or connected remotely through a communications network. You can also display printer status, and show jobs in printer queues.

Use the Get Printers button to locate available printers, or enter a URI (Uniform Resource Identifier) field, as described below.

First select a PRINTER button on the bottom of the screen: PRINTER 2 through PRINTER 5.

Note: The Integral printer TLSIntegralPrinter occupies PRINTER 1. This device is installed in the left door of the console.

## Printer Setup Screen 2



08/03/2011 11:27 AM		Ae 17: SETUP DATA WARNING		?		?		?		?		?	
Printer Setup - Setup										PRINTER 1 : TLSIntegralPrinter		Get Printers	
Setup		Status		Jobs									
Driver Selection		Automatic driver selection						▼					
Driver		APS CP324HRS, 0.11.1						▼					
Paper Size		Roll80mm						▼					
										✓			
										✗			
										▲			
PRINTER 1 (Default)		PRINTER 2		PRINTER 3		PRINTER 4		PRINTER 5		◀		▶	
										▼			

### Setup a Printer with the Get Printers Button

- Touch the Get Printers button on the right. The button dims to indicate that the console is searching for printers.
- When the button is not dimmed you can select a printer from the available printers listed in the Printer drop-down list.
- Set the Is Default field to Yes or No. The default printer is the first to display when you touch the Print Button on the top of the screen.
- Enter a Label for the printer. The console will display this label when you Print, display the Printer Status or display Print Jobs.
- Set the Driver Selection field to Manual driver selection if you want to select a Driver from the list of available drivers. Otherwise the console will choose the driver automatically based on the printer.

## TLS-450 Setup and Operation Screens Manual

- Select a Paper Size to adjust the size of the printed page. The selections that you see depend on the print driver selected.
- Select Enabled in the Configured drop-down list.

Touch the **Check** button  to complete configuration, or touch the **Cancel** button  to clear the screen.

### Setup a Network Printer with URI Field

---

- Choose Add Network Printer from the Printer drop-down list.
- Touch the numeric keypad button to enter a Uniform Resource Identifier (URI) for a Network printer.
- Touch the Check button to search for the printer on the network. If the printer is detected the console will display the full network address in the URI field. If it is not detected the console will clear the URI field.
- Set the Is Default field to Yes or No. The default printer is the first to display when you touch the Print Button on the top of the screen.
- Enter a Label for the printer. The console will display this label when you Print, display the Printer Status or display Print Jobs.
- Set the Driver Selection field to Manual driver selection if you want to select a Driver from the list of available drivers. Otherwise the console will choose the driver automatically based on the printer.
- Select a Paper Size to adjust the size of the printed page. The selections that you see depend on the print driver selected.
- Select Enabled in the Configured drop-down list.

Touch the **Check** button to complete configuration, or touch the **Cancel** button to clear the screen.

### Removing Printers

---

Note: You cannot remove a printer from the available screens PRINTER 2 through PRINTER 5. You can, however, reuse the screens by assigning a different printer.

### Model Information

The console stores and displays Model information about printers, for example HP LaserJet. This information is obtained from the software driver associated with the printer, so it may be generic in nature.

## Printer Setup - Status

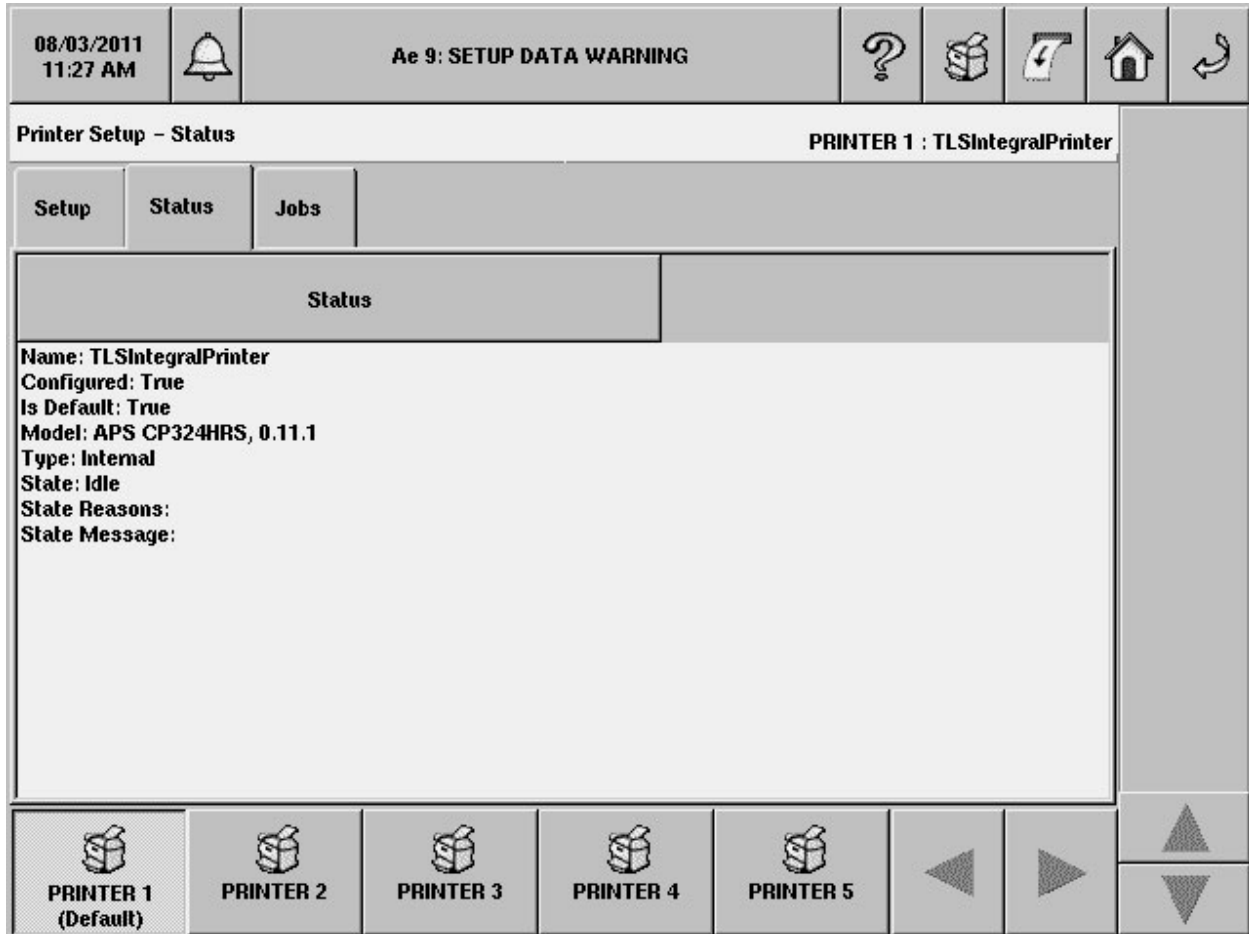

This screen displays the current status of connected printers.

Touch a PRINTER button on the bottom of the screen to select a printer screen number.

### Name

The Label assigned to this printer when it was added in the Printer Setup screen.

Note: The name TLSIntegralPrinter, and the PRINTER 1 screen number are assigned to the integral printer, which is installed in the left door of the console.

### Configured

True or false to indicate if the printer is currently configured.

### Is Default

The default printer is the first to display when you touch the Print Button on the top of the screen.

**Model**

The make and model of the printer, for example HP LaserJet. This information is obtained from the software driver associated with the printer, so it may be generic in nature.

**State**

The current printer state; for example Printing a Job, Stopped.

**State Reasons**

Any message that may be associated with the current state. For example, the paper tray is empty.

**State Messages**

Any messages generated from the last print request.



## Printer Setup – Jobs

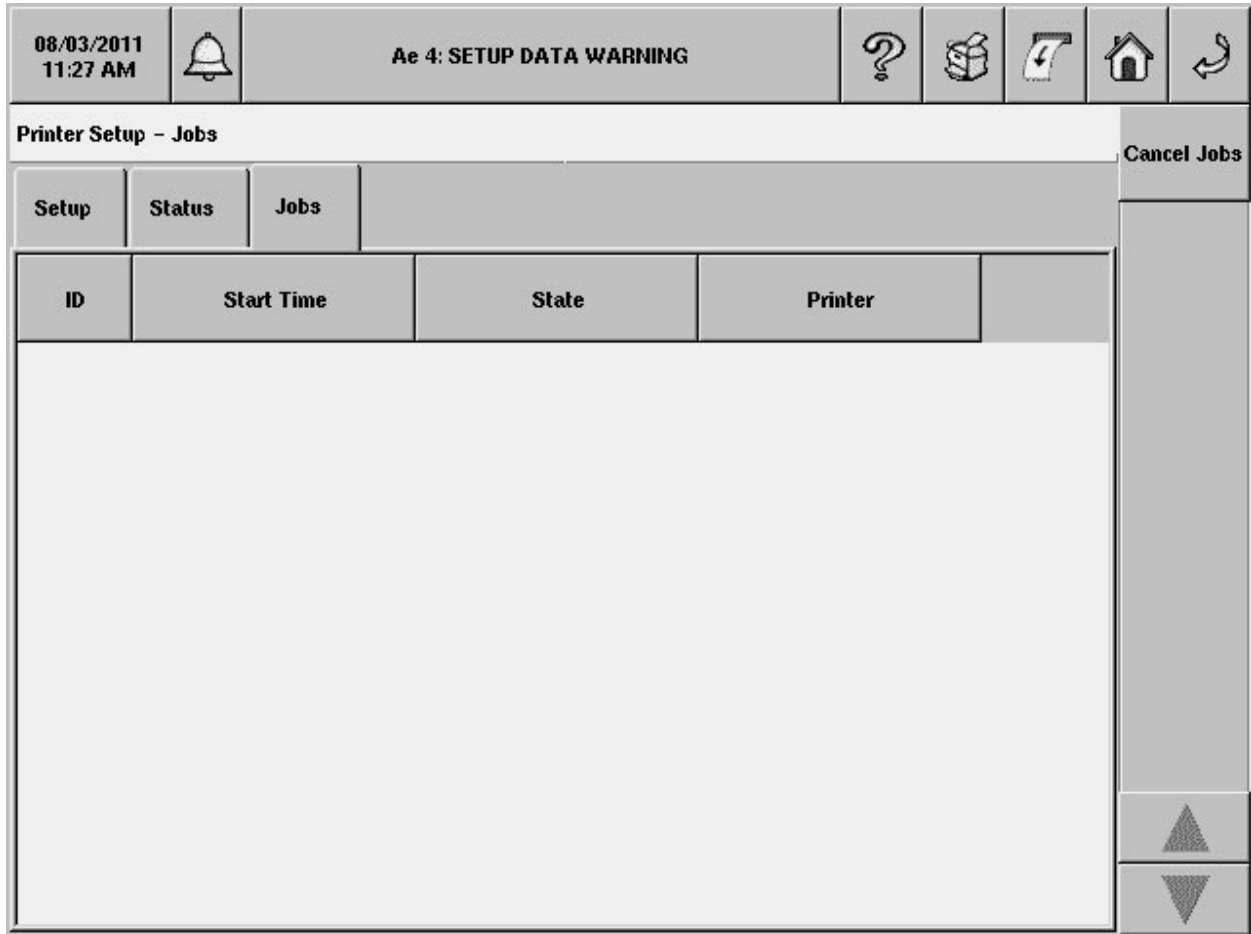

This screen displays a list of jobs in the printer queue.

### Job ID

An identification number assigned by the console to the print job.

### Start Time

The time the job started.

### State

The current state of the job; for example Pending, Processing, Stopped, Canceled, etc.

### Printer

The name assigned to the printer when it was added in the Printer Setup screen.

### Cancel Jobs button

Touch this button to cancel all jobs in the list.

## REPORTS

### Active Alarm Report

08/13/2008 01:59 PM		T 2: PROBE OUT							
Active Alarm Report									Help Mode
Active	History	Priority	Non-Priority						
#	Label	Alarm Description	Active Time	Clear Time					
T 2	Premium	SETUP DATA WARN	08/13/2008 01:59 PM						
T 1	Regular	SETUP DATA WARN	08/13/2008 01:59 PM						
T 1	Regular	PROBE OUT	08/13/2008 01:28 PM						
T 2	Premium	PROBE OUT	08/13/2008 01:28 PM						
T 3	Diesel	PROBE OUT	08/13/2008 01:27 PM	08/13/2008 01:59 PM					

The Active Alarm Report screen is the primary alarm report and shows all active and unacknowledged TLS alarms and warnings. You access this screen by touching the Alarm Access button at the top of the console screen. You can also access this screen by touching the alarm bell icon in a device's graphical display [Tank Status Detail](#) and [Sensor Status](#) screens.

Once in this screen, touching the Alarm Access button again will acknowledge all unacknowledged alarms and turn off the console beeper (if it is turned on).

All most recent Active Alarm Records will be shown at all times up to a maximum of 100.

#### Report Column Descriptions

#

This column lists the device code followed by device iteration number, e.g., T1. This column will be blank for system alarms that are not device specific.

**Label**

This column lists the label of the device that is in alarm. If it is a general system alarm, this column will be blank.

**Alarm Description**

This column lists the name of the alarm. If custom alarms are enabled, the custom alarm label will be displayed.

**Active Time**

This column lists the date/time the alarm was posted.

**Clear Date/Time**

This column will be blank in most cases, however, there may be cases where alarms that have cleared will appear in the Active Alarm List if the alarm has not yet been acknowledged.

**Active Alarm Report Screen Refresh Rate**

---

The active alarm data will be updated upon change of state.

**Control Button (on right of screen)**

---

**Help Mode**

Touching this button changes the report from a single- to a double-spaced row format. Touch an alarm and a dialog displays the cause of the selected alarm and the console's standard alarm corrective action. If custom alarm help has been enabled, and custom information entered for this alarm, the custom information will be displayed with a link to the console's standard alarm cause/action text.

The Help Mode feature is disabled by default.

## Alarm History Report

08/13/2008 01:28 PM		All Functions Normal					
<b>Alarm History Report - All Alarms</b>							Help Mode
From 07/29/2008 01:28 PM TO 08/13/2008 01:28 PM							
Active	History	Priority	Non-Priority				
#	Label	Alarm Description	Active Time	Clear Time			
T 1	Regular	PROBE OUT	08/13/2008 01:28 PM	08/13/2008 01:28 PM			
T 2	Premium	PROBE OUT	08/13/2008 01:28 PM	08/13/2008 01:28 PM			
T 3	Diesel	PROBE OUT	08/13/2008 01:27 PM	08/13/2008 01:27 PM			
							Select Range

The Alarm History Report screen displays alarms for all devices, regardless of priority level and state. TLS alarm events are added to the history when an alarm becomes active, is acknowledged or is cleared. The default view is the 100 most recent alarm events.

### Report Column Descriptions

**#**

This column lists the device code followed by device iteration number, e.g., T1. This column will be blank for system alarms that are not device specific.

**Label**

This column lists the label of the device that is in alarm. If it is a general system alarm, this column will be blank.

**Alarm Description**

This column lists the name of the alarm. If custom alarms are enabled, the custom alarm label will be displayed.

**Active Time**

This column lists the date/time the alarm was posted.

**Clear Date/Time**

This column lists the date/time the alarm was cleared.

**Control Buttons (on right of screen)**

---

**Help Mode**

Touching this button changes the report from a single- to a double-spaced row format. Touch an alarm and a dialog displays the cause of the selected alarm and the console's standard alarm corrective action. If custom alarm help has been enabled, and custom information entered for this alarm, the custom information will be displayed with a link to the console's standard alarm cause/action text.

The Help Mode feature is disabled by default.

**Select Range**

Touch this button to modify (filter) the contents of the report.

**Period**

Default selection: Date Range

**From**

Default Selection: A date 15 days back from today, Time now

**To**

Default Selection: Today's date, Time now

## Priority Alarm History Report

2007/11/06 04:37 PM			T 1: LOW PRODUCT ALARM						
Alarm History Report – Priority #1								More	
Active	History	Priority	Non-Priority						Help Mode
#	Label	Alarm Description	Active Time	Clear Time.....					
T 1		SUDDEN LOSS ALARM	2007/11/06 04:17 PM						
T 1		LOW PRODUCT ALARM	2007/11/06 04:16 PM						
								Select Range	

The Priority Alarm History Report screen displays priority alarms. TLS alarm events are added to the history when an alarm becomes active, is acknowledged or is cleared. The default view is the 100 most recent alarm events.

### Report Column Descriptions

#

This column lists the device code followed by device iteration number, e.g., T1. This column will be blank for system alarms that are not device specific.

#### Label

This column lists the label of the device that is in alarm. If it is a general system alarm, this column will be blank. The "Label" field can also be "empty" when the user has NOT assigned any label to the "device".

#### Alarm Description

This column lists the name of the alarm. If custom alarms are enabled, the custom alarm label will be displayed.

#### Active Time

This column lists the date/time the alarm was posted.

### **Clear Date/Time**

This column lists date/time the alarm was cleared.

## **Control Buttons (on right of screen)**

---

### **Help Mode**

Touching this button changes the report from a single- to a double-spaced row format. Touch an alarm and a dialog displays the cause of the selected alarm and the console's standard alarm corrective action. If custom alarm help has been enabled, and custom information entered for this alarm, the custom information will be displayed with a link to the console's standard alarm cause/action text.

The Help Mode feature is disabled by default.

### **Select Range**

Touch this button to modify (filter) the contents of the report.

### **Period**

Default selection: Date Range

### **From**

Default Selection: A date 15 days back from today, Time now

### **To**

Default Selection: Today's date, Time now

## Non-Priority Alarm History Report

2007/11/06 12:25 PM			T 3: SETUP DATA WARNING						
Alarm History Report - Non-Priority #1								More	
Active	History	Priority	Non-Priority						Help Mode
#	Label	Alarm Description	Active Time	Clear Time.....					
T 1		DELIVERY NEEDED	2007/11/06 09:52 AM						
T 4		SETUP DATA WARNING	2007/11/06 09:46 AM						
T 2		SETUP DATA WARNING	2007/11/06 09:44 AM						
T 1		SETUP DATA WARNING	2007/11/06 09:43 AM						
								Select Range	

The Non-Priority Alarm History report displays non-priority alarms. TLS alarm events are added to the history when an alarm becomes active, is acknowledged or is cleared. The default view is the 100 most recent alarm/warning events.

### Report Column Descriptions

#### #

This column lists the device code followed by device iteration number, e.g., T1. This column will be blank for system alarms that are not device specific.

#### Label

This column lists the label of the device that is in alarm. If it is a general system alarm, this column will be blank.

#### Alarm Description

This column lists the name of the alarm. If custom alarms are enabled, the custom alarm label will be displayed.



**Active Time**

This column lists the date/time the alarm was posted.

**Clear Date/Time**

This column lists the date/time the alarm was cleared.

**Control Buttons (on right of screen)**

---

**Help Mode**

Touching this button changes the report from a single- to a double-spaced row format. Touch an alarm and a dialog displays the cause of the selected alarm and the console's standard alarm corrective action. If custom alarm help has been enabled, and custom information entered for this alarm, the custom information will be displayed with a link to the console's standard alarm cause/action text.

The Help Mode feature is disabled by default.

**Select Range**

Touch this button to modify (filter) the contents of the report.

**Period**

Default selection: Date Range

**From**

Default Selection: A date 15 days back from today, Time now.

**To**

Default Selection: Today's date, Time now.

## Inventory Reports

### Inventory Reports - Current Inventory

2007/11/06 10:52 AM		T 2: SETUP DATA WARNING	?			
<b>Current Inventory Report</b>						<b>All Tanks</b>
<b>Current Inventory</b>	<b>Inventory History</b>		<b>Shift Inventory</b>			
<b>Fuel Volume</b>	<b>Ullage</b>	<b>Fuel Height</b>	<b>Water Height</b>	<b>Water Volume</b>	<b>Fuel Temp</b>	
Tank 1 :	4093	5907	38.6	3.0	100	71.9
Tank 2 :	4093	5907	38.6	3.0	100	71.9
Tank 3 :	6346	3653	54.6			75.6
Tank 4 :	1277	8722	16.7	2.5	77	76.6
All Tanks	Tank 1	Tank 2	Tank 3	Tank 4		

The Inventory Reports - Current Inventory screen lists inventory data for all currently active and configured tanks.

Note: References to probes are for probes that assigned to the tank. If the tank has no assigned probe, and probe data is not available, the related field(s) will be blank. For fields that are dependent on the capabilities of the probe, the column headings will print but the field will be blank, e.g., Water Height for probes that do not have a water float. In the All Tanks view, where it is possible that a site is configured with probes with different capabilities, some tanks will report temperature and/or water and some may not.

#### Report Column Descriptions

---

##### Fuel Volume

Allowable range: 0 to 264,172 gal (0 to 999,999L)

##### Fuel TC Volume

The Fuel TC Volume column will not be displayed unless the Print TC Volume feature is enabled in System Setup and the probe measures temperature.

Allowable range: 0 to 264,172 gal (0 to 999,999L)

**Mass**

This column will not display if the probe does not measure density.

Allowable range: Depends on tank volume and fuel density

**Fuel Density**

This column will not display if the probe does not measure density.

Allowable range: 42.139 to 56.185 lbs/ft<sup>3</sup> (675.00 to 900.00 kg/m<sup>3</sup>)

**Fuel TC Density**

This column will not display if the probe does not measure density and if TC density is not enabled.

Allowable range: 42.139 to 56.185 lbs/ft<sup>3</sup> (675.00 to 900.00 kg/m<sup>3</sup>)

**Ullage 100%**

Allowable range: 0 to 264,172 gal (0 to 999,999L)

**Ullage xx%**

The User defined ullage is only displayed if defined in 'All Tank' setup.

Allowable range: 0 to 264,172 gal (0 to 999,999L)

**Fuel Height**

Allowable range: 0 to 390.0 in. (0 to 9906.0mm)

**Water Height**

This column will be blank if the probe does not measure water.

Allowable range: 0 to 390.0 in. (0 to 9906.0mm)

**Water Volume**

This column will be blank if the probe does not measure water.

Allowable range: 0 to 264,172 gal (0 to 999,999L)

**Fuel Temp.**

This column will be blank if the probe does not measure temperature.

Allowable range: -40.0 to 140.0°F (-40.0 to 60.0°C)

**Current Inventory Report Screen Refresh Rate**

---

The current inventory data will be refreshed every 30 seconds.

## Inventory Reports - Inventory History

07/28/2008 02:44 PM		Ch 7: AUTODIAL FAILURE					
<b>Inventory History Report</b>						Tank 1 : REGULAR	
From 07/13/2008 02:44 PM TO 07/28/2008 02:44 PM							
Current Inventory	Inventory History	Shift Inventory					
Date & Time	Fuel Volume	Fuel Height	Water Height	Fuel Temp			
Tank 1 : REGULAR							
07/28/2008 02:32 PM	2694	32.7	0.0	60.0			
							Select Range
 Tank 1	 Tank 2	 Tank 3					

The Inventory Reports - Inventory History screen displays the inventory history. The default view is the most recent 10 inventory history records for All Tanks.

The Inventory History report close times are configured in system setup, Date & Time - Report Times. Possible configurations are daily, at shift close (if enabled), at day close (if enabled through Variance Analysis), or hourly configurations (at specific time of day, with interval set from every 1 to 24 hours).

### Report Column Descriptions

---

#### Date and Time

Date and time entry was recorded.

Allowable range: 01/01/2005 - 12/31/2038 00:00 - 23:59

#### Fuel Volume

Allowable range: 0 to 264,172 gal (0 to 999,999L)

#### Fuel TC Volume

The Fuel TC Volume column will not be displayed unless the Print TC Volume feature is enabled in System Setup and probe measures temperature.

## **TLS-450 Setup and Operation Screens Manual**

Allowable range: 0 to 264,172 gal (0 to 999,999L)

### **Mass**

This column will not display if the probe does not measure density.

Allowable range: Depends on tank volume and fuel density

### **Fuel Density**

This column will not display if the probe does not measure density.

Allowable range: 42.139 to 56.185 lbs/ft<sup>3</sup> (675.00 to 900.00 kg/m<sup>3</sup>)

### **Fuel TC Density**

This column will not display if the probe does not measure density and if TC density is not enabled.

Allowable range: 42.139 to 56.185 lbs/ft<sup>3</sup> (675.00 to 900.00 kg/m<sup>3</sup>)

### **Fuel Height**

Allowable range: 0 to 390.0 in. (0 to 9906.0mm)

### **Water Height**

This column will be blank if the probe does not measure water.

Allowable range: 0 to 390.0 in. (0 to 9906.0mm)

### **Fuel Temp.**

This column will be blank if the probe does not measure temperature.

Allowable range: -40.0 to 140.0°F (-40.0 to 60.0°C)

## **Control Button (on right of screen)**

---

### **Select Range**

Touch this button to modify (filter) the contents of the report.

### **Period**

Default selection: All Records

### **Tank**

Default Selection: Current Tank

## Inventory Reports - Shift Inventory

10/25/2007 08:50 AM							
<b>Shift Inventory Report</b>			Tank 3 : Tank3				
Current Inventory	Inventory History	Shift Inventory					
Shift	Fuel Volume	Ullage	Delivery Vol	Fuel Height	Water Height	Water Vol	Fuel Temp
<b>Tank 3 : Tank3</b>							
10/25/2007 06:00 AM	1806	193		23.7	0.0		73.9
10/25/2007 08:43 AM	1806	193	0	23.7	0.0		74.2
10/24/2007 06:00 PM	1806	193		23.7	0.0		75.0
10/24/2007 07:00 PM	1806	193	0	23.7	0.0		74.9
10/24/2007 07:00 PM	1806	193		23.7	0.0		74.9
11/01/1970 12:00 AM	0	0	0	0.0	0.0		0.0
<div style="display: flex; justify-content: space-between; align-items: center; padding: 5px;"> <div style="display: flex; gap: 10px;"> <div style="text-align: center;"> All Tanks</div> <div style="text-align: center;"> Tank 1</div> <div style="text-align: center;"> Tank 2</div> <div style="text-align: center;"> Tank 3</div> </div> <div style="display: flex; gap: 10px;"> <div style="text-align: center;"></div> <div style="text-align: center;"></div> <div style="text-align: center;"></div> <div style="text-align: center;"></div> </div> </div>							

The Inventory Report - Shift Inventory screen displays the data for all enabled shifts. Up to four completed shifts can be displayed. Only data for shifts that have closed as well as the current shift will be displayed. Each shift record is displayed on two lines. The first line displays data for the start of the shift. The second line displays data at the shift close (for a closed shift), or at a time when Shift Report is selected (for the current shift). The Shift inventory data will be refreshed every 30 seconds.

### Report Column Descriptions

#### Shift

Allowable range: 01/01/2005 - 12/31/2038 00:00 - 23:59

#### Fuel Volume

Allowable range: 0 to 264,172 gal (0 to 999,999L)

#### Fuel TC Volume

The Fuel TC Volume column will not be displayed unless the Print TC Volume feature is enabled in System Setup and the probe measures temperature.

Allowable range: 0 to 264,172 gal (0 to 999,999L)

**Mass**

This column will not display if the probe does not measure density.

Allowable range: Depends on tank volume and fuel density

**Fuel Density**

This column will not display if the probe does not measure density.

Allowable range: 42.139 to 56.185 lbs/ft<sup>3</sup> (675.00 to 900.00 kg/m<sup>3</sup>)

**Fuel TC Density**

This column will not display if the probe does not measure density and if TC density is not enabled.

Allowable range: 42.139 to 56.185 lbs/ft<sup>3</sup> (675.00 to 900.00 kg/m<sup>3</sup>)

**Ullage 100%**

Allowable range: 0 to 264,172 gal (0 to 999,999L)

**Ullage xx%**

The User defined ullage is only displayed if defined in 'All Tank' setup.

Allowable range: 0 to 264,172 gal (0 to 999,999L)

**Delivery Volume**

A Delivery Volume entry only appears if a delivery was made during the shift.

Allowable range: 0 to 264,172 gal (0 to 999,999L).

**Fuel Height**

Allowable range: 0 to 390.0 in. (0 to 9906.0mm)

**Water Height**

This column will be blank if the probe does not measure water.

Allowable range: 0 to 390.0 in. (0 to 9906.0mm)

**Water Volume**

This column will be blank if the probe does not measure water.

Allowable range: 0 to 264,172 gal (0 to 999,999L)

**Fuel Temp.**

This column will be blank if the probe does not measure temperature.

Allowable range: -40.0 to 140.0°F (-40.0 to 60.0°C)

## Environmental Reports

### Environmental Reports - Combined Tank Test

09/03/2009 07:19 PM		Ms 11: COMMUNICATION ALARM					
Combined Tank Test Report - Passed Test Results #1						Tank 2 : PRODUCT 2	
Combined Tank Test		Line Leak	Sensor Status	Sensor History			
Report Type	Date & Time	Test Method	Total Hours	Average Volume	% June..	More	
Tank 2 : PRODUCT 2							
Last Gross	10/21/2008 07:27 AM	SLD		3000	30.0		
Last Periodic	10/21/2008 05:16 AM	CSLD	38	3000	30.0		
Fullest Periodic	10/18/2008 07:57 AM	CSLD	12	3000	30.0		
Tank 1		Tank 2		Tank 3		Tank 4	
Tank 5		Tank 6					

The Environmental Reports - Combined Tank Test screen displays both Static Leak Detect (SLD) and Continuous Statistical Leak Detection (CLSD) test results on one report. This is a historic report and displays only results with a status of Passed. There are several categories of results that may be captured in this report:

- Last Gross Test Passed
- Last Periodic Test Passed
- Last Annual Test Passed
- Fullest Periodic Test Passed Each Month
- Fullest Annual Test Passed For Current Year



## **Report Column Descriptions**

---

### **Test Type**

Possible messages:

- Fullest Annual
- Fullest Periodic
- Last Annual
- Last Gross
- Last Periodic

### **Date & Time**

Date and time of test.

### **Test Method**

Possible messages:

- SLD
- CSLD

### **Total Hours**

The Total Hours field will always be blank for a gross test. Gross tests run for 30 minutes maximum; the duration is not configurable or reported.

Possible length of test: 0 to 24

### **Average Volume**

Allowable range: 0 to 264,172 gal (0 to 999,999L)

### **% Volume**

Allowable range: 0.0 to 100.0%

## **Control Buttons (on right of screen)**

---

### **Tank Test Setup**

Touch this button open the Tank Setup – Environmental Test screen.

## **Regulatory Compliance**

---

Note: In-tank leak tests will not be declared a PASS unless the product level in the tank satisfies the minimum product level defined in our Third Party certification for the leak test being performed. In-tank leak tests performed with the product level below these minimum levels will be declared Invalid. Because the minimum product level requirements vary with local, state, and federal regulations, you need to ensure that the product level complies with the applicable regulations in your location.

## Line Leak Report Passed Test Results

09/03/2009 07:20 PM		G 4: FUEL ALARM			?		?		?		?		?								
Line Leak Reports - Passed Test Results #1										Line 1 : PRESSURE LLD #1				✕							
Combined Tank Test			Line Leak		Sensor Status		Sensor History			More											
Test Type		Date & Time		Test Method		Gross Test Prev. 24 Hours			Gross Test since Midnight												
Line 1 : PRESSURE LLD #1																					
Gross				PLLD					3 3												
Last Annual		10/20/2008 02:15 PM		PLLD																	
Last Periodic		10/20/2008 01:55 PM		PLLD																	
Last Gross		10/20/2008 01:16 PM		PLLD																	
All Lines		Line 1		Line 2		Line 3		Line 4		Line 5		Line 6		▶		▶		▲		▼	

The Line Leak Reports - Passed Test Results displays information about most-recent and historical line leak tests. This report area is visible only if your console has the PLLD option.

### Report Column Descriptions

#### Test Type

- First Annual (First 0.1 gph [0.38 lph] test passed for a given month)
- First Periodic (First 0.2 gph [0.76 lph] test passed for a given month)
- Last Annual (Last 0.1 gph test passed)
- Last Gross (Last 3.0 gph [11.3 lph] test passed)
- Last Periodic (Last 0.2 gph test passed)

There will only be one entry of Gross test history for each line.

#### Date and Time

This column lists the date and time of the test.

#### Test Method

This column lists the method of the line leak test, for example, Pressure Line Leak Detection (PLLD)

**Gross Test Prev. 24 Hours**

This column lists the number of gross tests passed in the previous 24 hours. This column is for Gross tests only and may be blank. There will be only one entry of Gross test history per line.

Allowable entries: 0 to 672

**Gross Test Since Midnight**

This column lists the number of gross tests passed since midnight. This column is for Gross tests only and may be blank. There will be only one entry of Gross test history per line.

Allowable entries: 0 to 672





**Control Button (on right of screen)**

---

**Setup**

Touch this button open the Pump and Lines Setup - Lines screen.

## Environmental Reports - Sensor Status

09/03/2009 07:20 PM		T 3: PROBE OUT		    	
Sensor Status Report - All Sensors					View Data
Combined Tank Test		Line Leak	Sensor Status	Sensor History	
#	Sensor Location	Status			
L 1	Liquid Sensor 1	FUEL ALARM			
L 2	Liquid Sensor 2	FUEL ALARM			
L 3	Liquid Sensor 3	FUEL ALARM			
L 4	Liquid Sensor 4	FUEL ALARM			
G 1	GW Sensor 1	FUEL ALARM			
G 2	GW Sensor 2	FUEL ALARM			
G 3	GW Sensor 3	FUEL ALARM			
G 4	GW Sensor 4	FUEL ALARM			
C 1	Type A 1	SHORT ALARM			
C 2	Type A 2	SENSOR OUT ALARM			
C 3	Type A 3	SHORT ALARM			
C 4	Type A 4	SHORT ALARM			
H 1	Type B 1	SHORT ALARM			
H 2	Type B 2	SHORT ALARM			
H 3	Type B 3	SHORT ALARM			
H 4	Type B 4	SHORT ALARM			
Ms 1	MagSensor 1	COMMUNICATION AL/			
Ms 2	MagSensor 2	COMMUNICATION AL/			
Ms 3	MagSensor 3	COMMUNICATION AL/			
Ms 4	MagSensor 4	COMMUNICATION AL/			
Ms 5	MagSensor 5	COMMUNICATION AL/			
Ms 6	MagSensor 6	COMMUNICATION AL/			
Ms 7	MagSensor 7	COMMUNICATION AL/			

The Sensor Status Report - All Sensors screen displays a report with the current status of the following stand-alone sensors:

- Liquid
- Type A (2-Wire CL)
- Type B (3-Wire CL)
- Mag
- Ground Water
- Vapor

If a sensor is not in alarm, it will display the sensor as 'normal'. If there are any active sensor alarms they will be displayed on this screen. At most there will be only 1 line per sensor either showing the sensor in alarm or in a normal condition. Since this report displays all sensor types, there is no bottom sensor ribbon used on this report. No select range is required as this a current status report and no report filter will be used because the user can sort by sensor type.

### Report Column Descriptions

#

This column lists the device code followed by device iteration number, e.g., L1.

**Sensor Location**

This column lists the location of the sensor, e.g., Regular STP Pump.

**Status**

This column lists the sensor status, as applicable.

Possible messages (depending on sensor type):

- Normal
- Fuel Alarm
- Out Alarm
- Short Alarm
- Water Alarm
- Water Out Alarm
- High Liquid Alarm
- Low Liquid Alarm
- Liquid Warning
- Setup Data Warning
- Communication Alarm
- Fault Alarm
- Fuel Warning
- Fuel Alarm
- Water Warning
- Water Alarm
- High Liquid Warning
- High Liquid Alarm
- Low Liquid Warning
- Low Liquid Alarm
- Temperature Warning
- Relay Active
- Install Alarm

## Environmental Reports - Sensor Status History

09/03/2009 07:20 PM		R 4: DEVICE OUT WARNING					
Sensor Status History Report - All Sensors							View Data
From 08/19/2009 07:20 PM TO 09/03/2009 07:20 PM							
Combined Tank Test	Line Leak	Sensor Status	Sensor History				Report Filter
#	Sensor Location	Status	Active Time	Clear Time			
L 1	Liquid Sensor 1	NORMAL					
L 2	Liquid Sensor 2	NORMAL					
L 3	Liquid Sensor 3	NORMAL					
L 4	Liquid Sensor 4	NORMAL					
G 1	GW Sensor 1	FUEL ALARM	09/03/2009 07:18 PM				
G 2	GW Sensor 2	FUEL ALARM	09/03/2009 07:18 PM				
G 3	GW Sensor 3	FUEL ALARM	09/03/2009 07:18 PM				
G 4	GW Sensor 4	FUEL ALARM	09/03/2009 07:18 PM				
C 1	Type A 1	NORMAL					
C 2	Type A 2	SENSOR OUT ALARM	09/03/2009 07:19 PM				
C 3	Type A 3	NORMAL					
C 4	Type A 4	NORMAL					
H 1	Type B 1	NORMAL					
H 2	Type B 2	NORMAL					
H 3	Type B 3	NORMAL					
H 4	Type B 4	NORMAL					
Ms 1	MagSensor 1	COMMUNICATION AL/	09/03/2009 07:19 PM				
Ms 2	MagSensor 2	COMMUNICATION AL/	09/03/2009 07:19 PM				
Ms 3	MagSensor 3	COMMUNICATION AL/	09/03/2009 07:19 PM				
Ms 4	MagSensor 4	COMMUNICATION AL/	09/03/2009 07:19 PM				
Ms 5	MagSensor 5	COMMUNICATION AL/	09/03/2009 07:19 PM				
Ms 6	MagSensor 6	COMMUNICATION AL/	09/03/2009 07:19 PM				
							Select Range

The Sensor Status History report displays the status of all sensors over a selected time period.

There can be multiple records (or rows) displayed for each sensor, depending on the number of alarm events during the selected time period. There will always be at least one record per configured and selected sensor. If a Sensor has no Alarms during the selected time period then there will be one record with no Active Time showing a "Normal" status for that sensor.

### Screen Title Bar

The top row will show the tab selected. In the example above : Sensor Status History Report - All Sensors. The second row will show the selected data time range of the report. In the example above: From *Date/Time* To *Date/ Time*.

### Report Column Descriptions

#

This column lists the device code followed by device iteration number, e.g., C1.

### Sensor Location

This column lists the location of the sensor.

**Status**

This column lists the sensor status, as applicable.

Possible messages include:

- Normal
- Fuel Alarm
- Out Alarm
- Short Alarm
- Water Alarm
- Water Out Alarm
- High Liquid Alarm
- Low Liquid Alarm
- Liquid Warning
- Setup Data Warning
- Communication Alarm
- Fault Alarm
- Fuel Warning
- Fuel Alarm
- Water Warning
- Water Alarm
- High Liquid Warning
- High Liquid Alarm
- Low Liquid Warning
- Low Liquid Alarm
- Temperature Warning
- Relay Active
- Install Alarm

**Active Time**

Active time is the alarm post time. This column entry is blank if the device is in a "normal" status.

**Clear Time**

Clear time is the alarm post time. This column entry is blank if the device is in a "normal" status

**Control Buttons (on right of screen)**

---

**Report Filter**

Touch this button to select an individual Sensor Status Report from your available list of sensor types (selections dependent on installed sensors):

- All Sensors
- Liquid
- Type A (2-Wire CL)
- Type B (3-Wire CL)
- MAG
- Ground Water
- Vapor

**Select Range**

## **TLS-450 Setup and Operation Screens Manual**

Touch this button to open a dialog box and select a specific time span for the report.

Option selections: Week, Month, Year, Date Range (Date From and Date To only), All Records

Period range: Previous, Previous n selections.

Number of Period option selections: Weeks (1 to 156), Months (1 to 36), Years (1 to 3)

Default selections: Previous year

For more information on selecting report ranges, refer to [Report Range Selection Dialogs](#) help topic under Specialty Dialogs in the Online Help Table of Contents.



## Delivery Reports

### Delivery Report - Manual Delivery

03/05/2010 03:02 PM		Pm 1: PUMP OUT						
<b>Manual Delivery Status</b>								Start
<b>Manual Delivery</b>	<b>Last Delivery</b>	<b>Delivery History</b>	<b>Adjusted Delivery</b>					Stop
<b>Tank</b>	<b>Volume</b>	<b>Manual Delivery In Progress</b>						
Tank 1 : regular	3976	No						

The Manual Delivery report screen allows you to perform a manual delivery and is available only if the Delivery Method selected in [Delivery Setup](#) is Manual. Units are as selected in [Display Setup - Language & Units](#).

#### Report Column Descriptions

---

##### **Tank**

This column lists the configured tank label.

##### **Volume**

This column displays the non-temperature compensated volume in the tank.

##### **Manual Delivery In Progress**

Manual Delivery In Progress does not display status of a TLS detected delivery, but only of the manual delivery.

Possible messages: Yes or No

## **Control Buttons (Right Side of Screen)**

---

The **Start** and **Stop** buttons are used to perform a manual delivery to a selected tank.

1. You must determine the tank getting the delivery is in a quiet period by visual inspection of volume change (This volume is the Tank's Inventory Volume).
2. Once the **Start** button is touch to record the Delivery, there will be a 30 minute timeout period after which the Delivery will be declared ended (in case you forget to manually stop the Delivery).

### **Start (manual delivery)**

To manually start a delivery, touch the tank in the data area of the report that will receive the delivery. Notice the **Start** and **Stop** buttons are activated. Touch the Start button and begin delivering fuel to the tank.

### **Stop (manual delivery)**

Once the delivery is completed, touch the Stop to record the end of the delivery.

## Last Delivery Report

03/05/2010 03:02 PM		T 1: SETUP DATA WARNING						
Last Delivery Report							Tank 1 : regular	More
Manual Delivery	Last Delivery	Delivery History	Adjusted Delivery					
Start/End Date&Time	Fuel Volume	Fuel TC Volume	Water Height	Fuel Temp...				
All Tanks	Tank 1							

The Last Delivery Report screen serves as the default screen for the Fuel Management Reports. The purpose of the Last Delivery Report is to show the most recent increase in a tank's inventory.

The delivery record contains three lines:

- **Start** - This line contains date/tank data recorded at the start of the delivery.
- **End** - This line contains date/tank data recorded at the end of the delivery.
- **Amount (delivered)** - This line contains the difference between the start of delivery volume and end of delivery volume (standard volume and TC volume if applicable)  
Allowable range: 0 to 264,172 gal (0 to 999,999L).

For Manifolder Tanks the delivery sum of all tanks in the Manifolder set will be included (TC volume sum for the manifolded tanks will also appear if applicable).

## **Report Column Descriptions**

---

### **Start/End Date & Time**

Allowable range: 01/01/2005 to 12/31/2038 (MMDDYYYY) 00:00 to 23:59 (HH:MM)

### **Fuel Volume**

Allowable range: 0 to 264,172 gal (0 to 999,999L)

### **Fuel TC Volume**

The Fuel TC Volume column will not be displayed unless the Print TC Volume feature is enabled in System Setup and the probe measures temperature.

Allowable range: 0 to 264,172 gal (0 to 999,999L)

### **Mass**

This column will not display if the probe does not measure density.

Allowable range: Depends on tank volume and fuel density

### **Fuel Density**

This column will not display if the probe does not measure density.

Allowable range: 42.139 to 56.185 lbs/ft<sup>3</sup> (675.00 to 900.00 kg/m<sup>3</sup>)

### **Fuel TC Density**

This column will not display if the probe does not measure density and if TC density is not enabled.

Allowable range: 42.139 to 56.185 lbs/ft<sup>3</sup> (675.00 to 900.00 kg/m<sup>3</sup>)

### **Water Height**

This column will be blank if the probe does not measure water.

Allowable range: 0 to 390.0 in. (0 to 9906.0mm)

### **Fuel Temp.**

This column will be blank if the probe does not measure temperature.

Allowable range: -40.0 to 140.0°F (-40.0 to 60.0°C)

### **Fuel Height**

Allowable range: 0 to 390.0 in. (0 to 9906.0mm)

## Delivery History Report

03/05/2010 03:02 PM		F 1: SETUP DATA WARNING					
<b>Delivery Report</b>						Tank 1 : regular	More
Current Month							
Manual Delivery	Last Delivery	Delivery History	Adjusted Delivery				
Start/End Date&Time	Fuel Volume	Fuel TC Volume	Water Height	Fuel Temp...			
Tank 1 : regular							
							Select Range
 Tank 1						 	

The Delivery History Report screen shows the last 10 deliveries for the selected tank.

Each delivery record contains three lines:

- **Start** - This line contains date/tank data recorded at the start of the delivery.
- **End** - This line contains date/tank data recorded at the end of the delivery.
- **Amount (delivered)** - This line contains the difference between the start of delivery volume and end of delivery volume (standard volume and TC volume if applicable).  
Allowable range: 0 to 264,172 gal (0 to 999,999L)

### Report Column Descriptions

---

#### Start/End Date & Time

Allowable range: 01/01/2005 to 12/31/2038 00:00 - 23:59

**Final Volume**

Allowable range: 0 to 264,172 gal (0 to 999,999L)

**Fuel TC Volume**

The Fuel TC Volume column will not be displayed unless the Print TC Volume feature is enabled in System Setup and the probe measures temperature.

Allowable range: 0 to 264,172 gal (0 to 999,999L)

**Mass**

This column will not display if the probe does not measure density.

Allowable range: Depends on tank volume and fuel density

**Fuel Density**

This column will not display if the probe does not measure density.

Allowable range: 42.139 to 56.185 lbs/ft<sup>3</sup> (675.00 to 900.00 kg/m<sup>3</sup>)

**Fuel TC Density**

This column will not display if the probe does not measure density and if TC density is not enabled.

Allowable range: 42.139 to 56.185 lbs/ft<sup>3</sup> (675.00 to 900.00 kg/m<sup>3</sup>)

**Water Height**

This column will be blank if the probe does not measure water.

Allowable range: 0 to 390.0 in. (0 to 9906.0mm)

**Fuel Temp.**

This column will be blank if the probe does not measure temperature.

Allowable range: -40.0 to 140.0°F (-40.0 to 60.0°C)

**Fuel Height**

Allowable range: 0 to 390.0 in. (0 to 9906.0mm)

**Control Button (on right of screen)**

---

**Select Range**

Touch this button to modify (filter) the contents of the report.

**Period**

Default selection: All Records

**Tank**

Default selection: Current Tank

## Delivery Report - Ticketed Delivery Report

03/05/2010 03:03 PM		F 1: SETUP DATA WARNING	?		7			
Ticketed Delivery Report - TC Volumes							Tank 1 : regular	Edit Record
Current Month								
Last Delivery	Delivery History	Adjusted Delivery	Ticketed Delivery			Add Record		
End Date&Time	Ticket Volume	Gauge Volume	Ticket - Gauge	Start Temp	End Temp	Estimated Delivery Temp	BOL...	
03/03/2010 01:01 PM	0	0	0	0.0	0.0	0.0		
							More	
							Select Range	
 Tank 1								

The Ticketed Delivery Report lets you view, add or edit ticketed deliveries to the selected tank.

If a delivery is in progress the data for all the columns will be 0. While a delivery is in progress, the Add button in the right column is not selectable. When the delivery in progress has completed, the 'In Progress' record will be replaced with the delivery end date and time and data.

Displayed volumes will be Standard Volumes if TC Ticketed Delivery is not enabled in Delivery Setup, or TC Volumes if TC Ticketed Delivery is enabled.

Units are as selected in [Display Setup - Language & Units](#).

### End Date

Delivery End Date and Time - MM/DD/YYYY HH:MM (default format)

### Gauge Volume

Volume in tank as read by probe.

### Ticket Volume

Volume entered from delivery ticket.

**Ticket - Gauge**

The ticket volume minus gauge volume.

**Start Temp**

Temperature of fuel in tank before the delivery.

**End Temp**

Temperature of fuel in tank after the delivery.

**Est. Delivery Temp**

Estimated temperature of the delivered fuel which the TLS derived by looking at the volume and temperature before and after the delivery and doing a mass/thermal-energy calculation.

**BOL**

The bill of lading entered for the delivery.

**Delivery ID**

This column displays any entered delivery identification.

**Control Button (on right of screen)**

---

**Edit Record**

NOTE: At least a single row of data must be present and selected before the 'Edit Record' button is activated.

Touch this button to edit the selected ticketed delivery record in the [Edit Ticket Delivery screen](#).

**Add Record**

Touch this button to add a ticketed delivery record in the [Add Ticket Delivery screen](#).

**More**

Touch this button to cause the 'Ticketed Delivery' tab screen to scroll to the right displaying columns and data that are hidden on the right and are not displayed in the data area of the screen.















**Select Range**

Touch this button to modify (filter) the contents of the report.



## Edit Delivery Ticket

This screen allows you to Edit a selected ticketed delivery record for the selected tank. Touch the Back button  to return to 'Ticketed Delivery' screen.

03/05/2010 03:35 PM		Ln 1: SETUP DATA WARNING					
<b>Edit Delivery Ticket</b>							Prev. Record
<b>Delivery End Time</b>	03/03/2010 01:01 PM						Next Record
<b>Tank</b>	Tank 1:regular						
<b>Measured Delivery</b>	0						
<b>Delivery Volume</b>	4500						
<b>TC Delivery Volume</b>	0						
<b>Bill of Lading</b>							
<b>Delivery ID</b>							
							

### Delivery End Time

Date and time delivery ended

### Tank

This is a read-only field showing the Tank receiving the delivery.

### Measured Delivery

This is a read-only field showing the delivered volume as measured by the TLS.

### Delivery Volume

Delivered volume as entered from the delivery ticket.

**TC Delivery Volume**

Visible only if TC Volume is selected for TC Ticketed Delivery in [Delivery Setup](#).

Delivered TC volume as entered from the delivery ticket.

**Bill of Lading**

Bill of lading entry.

Allowable selection: Up to 20 alpha-numeric characters

**Delivery ID**

Delivery identification entry.

Allowable selection: Up to 20 alpha-numeric characters

**Control Button (on right of screen)**

---

**Previous Record**

Touch this button to populate the 'Edit Delivery Ticket' screen with the row of data previous to the one that was selected in the 'Ticketed Delivery' screen.















**Next Record**

Touch this button to populate the 'Edit Delivery Ticket' screen with the row of data following the one that was selected in the 'Ticketed Delivery' screen.

## Add Delivery Ticket

This screen allows you to Add a ticketed delivery record for the selected tank. Touch the Back button

 to return to 'Ticketed Delivery' screen.

03/05/2010 03:35 PM		Ln 1: LINE OUT					
<b>Add Delivery Ticket</b>							
<b>Delivery End Date</b>	03/05/2010						
<b>Delivery End Time</b>	03:33 PM						
<b>Tank</b>	Tank 1:regular						
<b>Measured Delivery</b>	Not Available						
<b>Delivery Volume</b>	0						
<b>TC Delivery Volume</b>	0						
<b>Bill of Lading</b>							
							

**Delivery End Date**

Date delivery ended.

**Delivery End Time**

Time delivery ended.

**Tank**

This is a read-only field showing the Tank receiving the delivery.

**Measured Delivery**

This is a read-only field showing 'Not Available'.

**Delivery Volume**

Delivered volume as entered from the delivery ticket.

Allowable selection: 0 to 264,172 gal (0 to 999,999 liters)

**TC Delivery Volume**

Visible only if TC Volume is selected for TC Ticketed Delivery in [Delivery Setup](#).

Delivered volume as entered from the delivery ticket.

Allowable selection: 0 to 264,172 gal (0 to 999,999 liters)

**Bill of Lading**

Bill of lading entry.

Allowable selection: Up to 20 alpha-numeric characters

**Delivery ID**

Delivery identification entry.

Allowable selection: Up to 20 alpha-numeric characters

## Delivery Report - Adjusted Delivery Report

03/05/2010 03:03 PM							
<b>Adjusted Delivery Report</b>		Current Month	Tank 1 : regular				
Last Delivery	Delivery History	Adjusted Delivery	Ticketed Delivery				
Start Date	End Date	Start Volume	End Volume	Adjusted Delivery	TC Adj Delivery		
						Select Range	
 Tank 1							

This screen allows you to view adjusted delivery reports.

Units are as selected in [Display Setup - Language & Units](#).

### Report Column Descriptions

---

**Start Date**

Delivery Start Date and Time - MM/DD/YYYY HH:MM (default format)

**End Date**

Delivery End Date and Time - MM/DD/YYYY HH:MM (default format)

**Start Volume**

This column displays the volume in the tank before delivery.

**End Volume**

This column displays the volume in the tank after delivery.

**Adjusted Delivery**

This column displays the volume delivered.

**TC Adjusted Delivery**

Temperature compensated volume delivered. NOTE: This column only visible if Temperature Compensation is enabled (ref. [Tank Setup - All Tanks](#)).

**Control Button (on right of screen)**

---

**Select Range**

Touch the Select Range button to change the range of the data displayed. The default period is current month.

## BIR Reports

### Reconciliation Report - Reconciliation

03/05/2010 03:04 PM		F 1: SETUP DATA WARNING								
Reconciliation Report - Reconciliation #1								F 1:	Manual Adjust	
Current Month (Records and Summaries)										
Reconciliation	Book Variance	Reconciliation Test Report							BIR Diag	
Closing Date & Time	Variance	Opening Volume	Gauged Delivery	Metered Sales	Manual Adjust	Calculated Inventory	Ga I...	More		
								Report Filter		
 Product 1										

**NOTES:**

For Reconciliation Reports, the following conditions are true:

- The current Rolling Report starts N days ago and runs to yesterday.
- The previous Rolling Report starts N+1 days ago, and runs to the day before yesterday.
- Weekly Reports start the week on the day of the week set up in Inventory Setup - Inventory Report Times tab.
- The current week report will always be a partial report. The previous week report is a complete week.
- Monthly Reports start on the 1st of the month.
- The current Monthly report is a partial report that starts on the 1st of the month and goes to today.
- The previous Monthly report is a complete month from 1st to last day of the previous month

Units are as selected in [Display Setup - Language & Units](#).

## **Report Column Descriptions**

---

### **Date & Time**

This column contains the date/time of report (MM/DD/YYYY HH:MM - default format)

### **Shift#**

This column contains the number of the shift at the time of the report (not visible if shifts are not being used).

### **Variance**

This column contains the difference between calculated and measured volume.

### **Opening Volume**

This column contains the measured volume at start of reconciliation period.

### **Gauged Delivery**

This column contains the measured delivery increase adjusted for sales that occurred during the delivery.

### **Metered Sales**

This column contains the reported metered sales volume.

### **Calculated Inventory**

This column contains the calculated ending inventory derived from the measured starting volume minus reported sales plus measured deliveries.

### **Gauged Inventory**

This column contains the measured inventory at the end of the reconciliation period.

### **Manual Adjust**

This column contains a use-entered correction for known variance conditions, e.g., removing water from the tank, meter calibrating.

### **Water Height**

This column displays the tank's measured water height.

## **Control Buttons (on right side of screen)**

---

### **Manual Adjust**

If you need to enter an adjustment for this tank touch this button to open the 'Enter Manual Adjust' - dialog box described below. To return to the 'Reconciliation Report' tab screen, touch the Back button at the top right of the screen.

### **Product**

This field is read only and displays the tank's product.  
Possible messages: Up to 20 alpha-numeric characters.



**Date&Time**

This field is read only and displays the date and time in the MM/DD/YYYY HH:MM format (default).

**Tank**

This field displays the tank label. The Tank field defaults to the lowest tank number in the product group. If only one tank is in the product group, the selection cannot be changed. This field allows you to pick the tank of the product which needs a fuel adjustment.

**Manual Adjust**

Touch the keypad button to the right of this field to enter the desired volume adjustment.

Allowable range: 0 to 264,172 gal (0 to 999,999 Litres)

**Check (OK)**

Touch this button to accept the manual adjustment entry.

**Cancel (X)**

Touch this button to cancel the change.

**BIR Diags**

Touching the 'BIR Diags' button will display the Reconciliation Diagnostics screen:

- A Status tab displays the current status that impacts reconciliation data.
- A Reconciliation tab displays all records with Metered Sales, Variance and a reason(s) for the variance.

**More**

Touch this button to cause the 'Reconciliation' screen to scroll to the right displaying columns and data that are hidden on the right and are not displayed in the data area of the screen.

**Report Filter**

Touching the 'Report Filter' button displays the 'Report Filter' dialog. The 'Report Filter' dialog contains a 'Select Range' dialog and a 'Filter' selection dialog. The 'Select Range' dialog allows you to change the range of the displayed data. The 'Filter' selection dialog allows you to change between Daily View and Shift View.

**Daily**

- a. Select Range
  - Week Range - Current, Previous and Previous N periods
  - Month Range - Current, Previous and Previous N periods
  - Rolling - Current, Previous, and Previous n periods
  - Date Range
- b. Filter
  - Show
    - (1) Records and Summaries
    - (2) Records Only
    - (3) Summaries Only
- c. Defaults
  - Select Range

- (1) If Summary Period in Reconciliation Setup is Monthly - Current Month, displayed in terms of a By Month Range (Start is Current Month, End is Current Month)
- (2) If Summary Period in Reconciliation Setup is Rolling - Current (Displayed as Current)

- Filter

- (1) Show  
(Records and Summaries)

**Shift**

a. Select Range

- By Single Date (Using Day/Month/Year Single Date picker)
- By Week Range (Using Week/Year From/To Picker)
- By Month Range (Using Month/Year From/To Picker) N Periods)
- By Date Range (Using Day/Month/Year From/To Picker)

b. Filter

-Show

- (1) Records and Summaries
- (2) Records Only
- (3) Summaries Only

c. Defaults

- Select Range (Does not look at Summary Period Defaults in Reconciliation Setup)
  - (1) Current Day and Previous Day, displayed in terms of a Date Range (Start is Previous Day (Yesterday's Date), End is Current Day (Today's Date))

- Filter

- (1) Show  
(Records Only)

## Reconciliation Reports - Book Variance Report

03/05/2010 03:04 PM		Ln 1: SETUP DATA WARNING								
Reconciliation Report - Book Variance #1									F 1:	More
Current Month (Records and Summaries)										
Reconciliation		Book Variance		Reconciliation Test Report						
Closing Date & Time	Variance	Opening Volume	Ticketed Delivery	Metered Sales	Manual Adjust	Closed Book Inventory	G	...		
										Report Filter
 Product 1										

NOTES:

1. Book Variance report only appears when TC Ticketed Delivery is enabled in [Delivery Setup](#).
2. For Reconciliation Reports, the following conditions are true:
  - The current Rolling Report starts N days ago and runs to yesterday.
  - The previous Rolling Report starts N+1 days ago, and runs to the day before yesterday.
  - Weekly Reports start the week on the day of the week set up in Inventory Setup - Inventory Report Times tab.
  - The current week report will always be a partial report. The previous week report is a complete week.
  - Monthly Reports start on the 1st of the month.
  - The current Monthly report is a partial report that starts on the 1st of the month and goes to today.
  - The previous Monthly report is a complete month from 1st to last day of the previous month

## **Report Column Descriptions**

---

### **Date & Time**

This column contains the date/time of report (MM/DD/YYYY HH:MM - default format)

### **Opening Volume**

This column contains the measured volume at start of reconciliation period.

### **Metered Sales**

This column contains the reported metered sales volume.

### **Ticketed Delivery**

This column contains user-entered delivery volume.

### **Manual Adjust**

This column contains a user-entered correction for known variance conditions, e.g., removing water from the tank, meter calibrating.

### **Closed Book Inventory**

This column contains the calculated ending inventory derived from the measured starting volume minus reported sales plus ticketed deliveries.

### **Gauged Inventory**

This column contains the measured inventory at the end of the reconciliation period.

### **Variance**

This column contains the difference between calculated and measured volume.

### **Water Height**

This column displays the tank's measured water height.

## **Control Buttons (on right side of screen)**

---

### **More**

Touch this button to cause the 'Book Variance' screen to scroll to the right displaying columns and data that are hidden on the right and are not displayed in the data area of the screen.

### **Report Filter**

Touching the 'Report Filter' button displays the 'Report Filter' dialog. The 'Report Filter' dialog contains a 'Select Range' dialog and a 'Filter' selection dialog. The 'Select Range' dialog allows you to change the range of the displayed data. The 'Filter' selection dialog allows you to change between Daily View and Shift View.

**Daily**

- a. Select Range
  - Week Range - Current, Previous and Previous N periods
  - Month Range - Current, Previous and Previous N periods
  - Rolling - Current, Previous, and Previous n periods
  - Date Range
  
- b. Filter
  - Show
    - (1) Records and Summaries
    - (2) Records Only
    - (3) Summaries Only
  
- c. Defaults
  - Select Range
    - (1) If Summary Period in Reconciliation Setup is Monthly - Current Month, displayed in terms of a By Month Range (Start is Current Month, End is Current Month)
    - (2) If Summary Period in Reconciliation Setup is Rolling - Current (Displayed as Current)
  
  - Filter
    - (1) Show (Records and Summaries)

**Shift**

- a. Select Range
  - By Single Date (Using Day/Month/Year Single Date picker)
  - By Week Range (Using Week/Year From/To Picker)
  - By Month Range (Using Month/Year From/To Picker) N Periods)
  - By Date Range (Using Day/Month/Year From/To Picker)
  
- b. Filter
  - Show
    - (1) Records and Summaries
    - (2) Records Only
    - (3) Summaries Only
  
- c. Defaults
  - Select Range (Does not look at Summary Period Defaults in Reconciliation Setup)
    - (1) Current Day and Previous Day, displayed in terms of a Date Range (Start is Previous Day (Yesterday's Date), End is Current Day (Today's Date))
  
  - Filter
    - (1) Show (Records Only)

## Reconciliation Reports - Reconciliation Test Report

03/05/2010 03:05 PM		Pm 1: PUMP OUT						
Reconciliation Report - Reconciliation Test Report #1							F 1:	More
Current Month (Records and Summaries)								
Reconciliation	Book Variance	Reconciliation Test Report						
End Date	Test #/Type	Threshold Type	Result	Sales	Delivery	Variance	Thresho Limit...	
								Report Filter
 Product 1								

This screen contains Reconciliation Variable Threshold test results.

### Report Column Descriptions

**End Date**

Date of test.

**Threshold Type**

Disabled, Monthly, Rolling Day, Daily, Rolling Consecutive Day

**Result**

Pass/Fail

**Sales**

Sales volume in system units.

**Delivery**

Delivered volumes in system units.

**Variance**

Variance in system units.

**Threshold Limit**

Volume in system units.

**Control Buttons (on right side of screen)**

---

**More**

Touch this button to cause the 'Reconciliation Test Report' screen to scroll to the right displaying columns and data that are hidden on the right and are not displayed in the data area of the screen.

**Report Filter**

Touching the 'Report Filter' button displays the 'Report Filter' dialog. The 'Report Filter' dialog contains 'Period' dialog selections and 'Period Range' dialog selections.

## DIAGNOSTIC SCREENS

### Diagnostics Main Screen

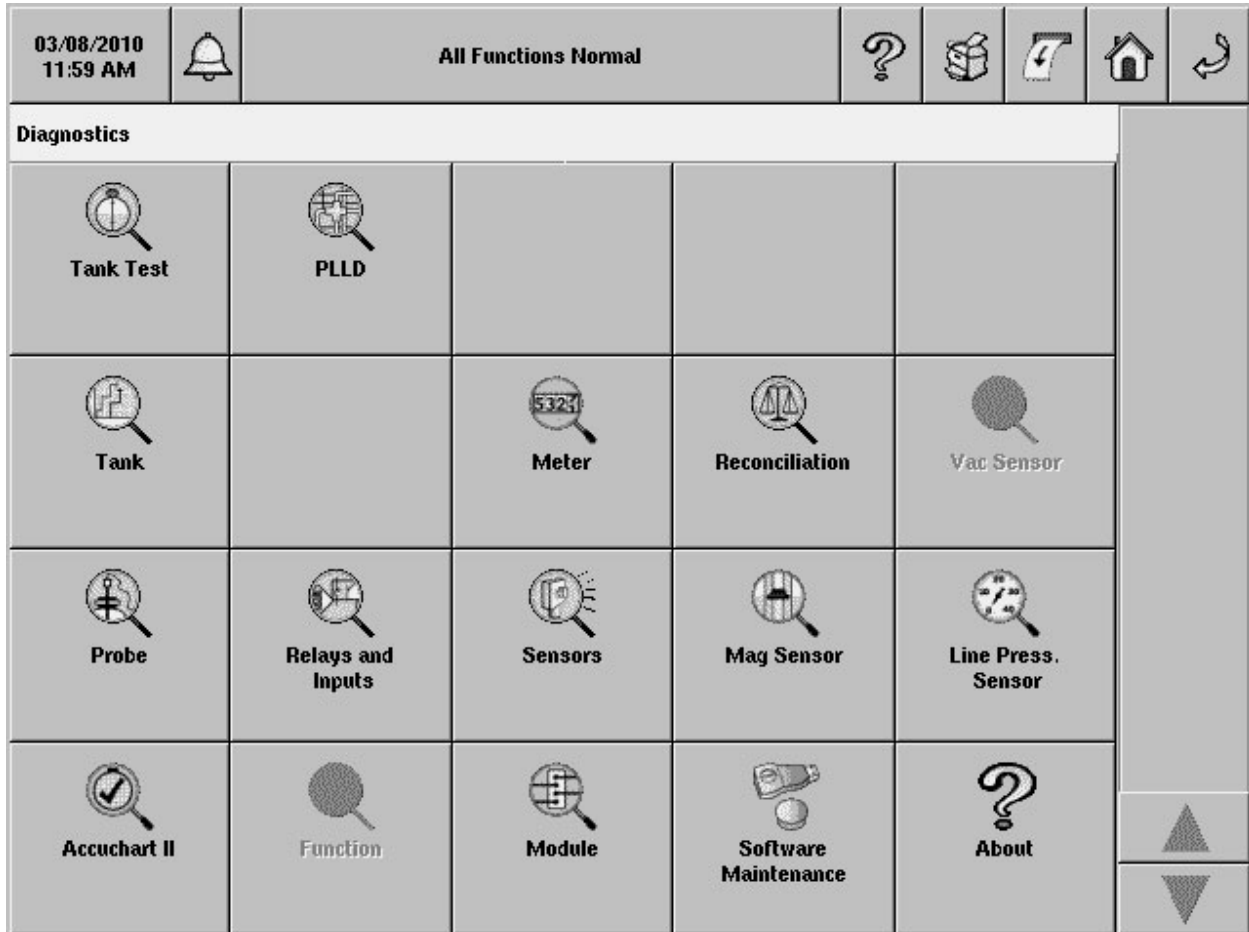

The Diagnostic main screen gives you access (depending on installed features) to the site's current and historical tank and line test results. Also from Diagnostic screens, you can manually run tank tests, PLLD line tests and view technical data from monitored devices. Detailed functions of diagnostic screens, which are used primarily by trained service personnel to analyze console/device performance, are not discussed in this manual.



## Tank Test Diagnostics

### Tank Test Diagnostics - CSLD Test Status

11/06/2007 05:42 PM		T 4: SETUP DATA WARNING				
Tank Test Diagnostics - CSLD Test Status						All Tanks
CSLD Test Status	CSLD Rate Table	CSLD Monthly	SLD Last Test			
#	Tank Label	Test Status	Minutes			
T 1	* PRODUCT1	End Delay	0.0			
T 2	* PRODUCT2	No Test	0.0			
T 3	* PRODUCT3	No Test	0.0			
T 4	* PRODUCT4	No Test	0.0			
T 5	* PRODUCT5	No Test	0.0			
T 6	* PRODUCT6	No Test	0.0			
All Tanks	Tank 1	Tank 2	Tank 3	Tank 4	Tank 5	Tank 6

The purpose of this screen is to display the CSLD current test status. The default view is all tanks. This report gives up-to-the-minute results; there is no history.

Siphon manifolded tanks are treated as one tank in CSLD. The tanks in the manifolded set share the same results.

Tanks that are not configured, do not have CSLD enabled, or are configured with a probe that does not support leak detection will not be accessible from this screen or included in this report.

#### Report Column Descriptions

#

This column lists the device code followed by device iteration number, e.g., C1.

#### Tank Label

This column lists the tank label.

## **Status**

Possible messages that will display in the Status column:

- No Test
- Test Pre-start
- Test in progress
- Test complete
- Test abort
- Test pre-delay
- Test end delay

## **Minutes**

Value range: 0.0 to 180.0 minutes

## **CSLD Test Status Refresh Rate**

---

The CSLD Test Status data will be refreshed every 30 seconds.

## **Regulatory Compliance**

---

Note: In-tank leak tests will not be declared a PASS unless the product level in the tank satisfies the minimum product level defined in our Third Party certification for the leak test being performed. In-tank leak tests performed with the product level below these minimum levels will be declared Invalid. Because the minimum product level requirements vary with local, state, and federal regulations, you need to ensure that the product level complies with the applicable regulations in your location.

## Tank Test Diagnostics - CSLD Rate Table

11/06/2007 05:43 PM		T 4: SETUP DATA WARNING					?			
Tank Test Diagnostics - CSLD Rate Table #1									All Tanks	
CSLD Test Status		CSLD Rate Table			CSLD Monthly		SLD Last Test			
Date/Time	Status	Leak Rate	Avg Temp	Top Temp	Brd Temp	Temp Rate	Disp Factor	Volume	Test Interval	
<b>Tank 1 : * PRODUCT1</b>										
10/20/2007 08:34 AM	0	-0.092	60.0	60.0	60.0	0.0	31	4947	174.5	
10/20/2007 11:34 AM	0	-0.001	60.0	60.0	60.0	0.0	26	4946	174.5	
10/20/2007 02:35 PM	0	-0.005	60.0	60.0	60.0	0.0	21	4946	174.5	
10/20/2007 05:35 PM	0	-0.005	60.0	60.0	60.0	0.0	16	4946	174.5	
10/20/2007 08:36 PM	0	-0.004	60.0	60.0	60.0	0.0	11	4946	174.5	
10/20/2007 11:36 PM	0	-0.003	60.0	60.0	60.0	0.0	7	4946	174.5	
<b>Tank 2 : * PRODUCT2</b>										
10/20/2007 01:35 PM	0	-0.008	60.0	60.0	60.0	0.0	407	4907	174.5	
10/20/2007 04:36 PM	0	-0.007	60.0	60.0	60.0	0.0	305	4907	174.5	
10/20/2007 07:36 PM	0	-0.005	60.0	60.0	60.0	0.0	267	4908	174.5	
10/20/2007 10:37 PM	0	-0.002	60.0	60.0	60.0	0.0	176	4907	174.5	
<b>Tank 3 : * PRODUCT3</b>										
10/20/2007 08:35 AM	0	-0.075	60.0	60.0	60.0	0.0	26	4956	174.5	
10/20/2007 11:35 AM	0	-0.003	60.0	60.0	60.0	0.0	21	4956	174.5	
10/20/2007 02:36 PM	0	-0.005	60.0	60.0	60.0	0.0	17	4956	174.5	
10/20/2007 05:36 PM	0	-0.003	60.0	60.0	60.0	0.0	13	4956	174.5	
10/20/2007 08:37 PM	0	-0.003	60.0	60.0	60.0	0.0	9	4956	174.5	
All Tanks	Tank 1	Tank 2	Tank 3	Tank 4	Tank 5	Tank 6				

The CSLD Rate Table diagnostic report lists detailed data for the last 30 days of CSLD leak tests. A maximum of 80 of the most recent tests are stored in the rate table. The default view is 30 days of data for all tanks.

Siphon manifolded tanks are treated as one tank in CSLD. The tanks in the manifolded set share the same table and results. Deleting the table for any tank within the set will in effect delete the table of all the members in the set.

You will only be able to access tanks that have CSLD enabled or have CSLD history.

### Report Column Descriptions

#### Date/Time

Value range: Date and Time

#### Status

- 0 = Test valid
- 1 = Test rejected - duration too short
- 2 = Test rejected - start time too close to a delivery
- 3 = Test rejected - excessive dispensing prior to test

## **TLS-450 Setup and Operation Screens Manual**

4 = Test rejected - excessive temperature change during test

6 = Test rejected -leak rate outlier

### **Leak Rate**

Value range: -26.417 to 26.417 gal/hour (-99.999 to 99.999 L/hour)

### **Avg Temp**

Value range: -40.0 to 140.0°F (-40.0 to 60.0°C)

### **Top Temp**

Value range: -40.0 to 140.0°F (-40.0 to 60.0°C)

### **Brd Temp**

Value range: -40.0 to 140.0°F (-40.0 to 60.0°C)

### **Temp Rate**

Note: The Temp rate field does not use the offset factor 32 for conversion of °C to °F

Value range: -40.0 to 99.9°F/hour (-22.2 to 55.5°C/hour)

### **Disp Factor**

Value range: 0 to 264,172 gal (0 to 999,999L)

### **Volume**

Value range: 0 to 264,172gal (0 to 999,999L)

### **Test Interval**

Value range: 0 to 672.0 hours (28 days maximum)

### **Last Divy**

Value range: 0 to 9999.9 hours

### **Ullage**

Value range: 0 to 264,172gal (0 to 999,999L)

### **Evap Rate**

Value range: 0 to 2.6 gal/Hour (0 to 9.9L/Hour)

## **Control Buttons (right of screen)**

---

### **CSLD Test Setup**

Touch this button open the Tank Setup - CSLD Test Setup screen

### **Clear Table**

You should manually clear the CSLD Rate Table if data, known to be inaccurate, had been stored in the table and the source of the inaccurate data was subsequently removed (e.g., after making tank plumbing repairs).



**IMPORTANT! DO NOT CLEAR THE CSLD RATE TABLE UNLESS IT IS ABSOLUTELY NECESSARY. DATA CLEARED FROM THIS TABLE CAN NOT BE RECOVERED!**

Touch the Clear Table button to clear the 30 day CSLD rate table. You will be prompted to confirm this action. The warning "Are you sure you want to clear the CSLD rate table?" is displayed, with OK and Cancel buttons. If the OK button is selected, the dialog is closed, the CSLD rate table is cleared, and the report is refreshed to reflect the change. If the Cancel button is selected, the dialog is closed and the report view is unchanged. If the Clear Table button is selected when the current tank selection is "All Tanks", the following error message is displayed: "This operation is valid for a single tank only".

### **Select Range**

Touch this button to setup the report's contents:

- **Select Option List** - Select data for report: All Records, Day, Week, Month, Year, Date Range
- **Period Option List** - Select period: Previous, Previous n selections
- **Select Tank(s)** - Select tank(s) to report: "All Tanks" or "Current Tank"

### **Regulatory Compliance**

---

Note: In-tank leak tests will not be declared a PASS unless the product level in the tank satisfies the minimum product level defined in our Third Party certification for the leak test being performed. In-tank leak tests performed with the product level below these minimum levels will be declared Invalid. Because the minimum product level requirements vary with local, state, and federal regulations, you need to ensure that the product level complies with the applicable regulations in your location.

## Tank Test Diagnostics - CSLD Monthly

11/05/2007 02:19 PM		T 4: PERIODIC TEST FAIL	?																					
Tank Test Diagnostics - CSLD Monthly Report						All Tanks																		
CSLD Rate Table	CSLD Monthly	SLD Last Test	SLD In Progress	S His																				
Date/Time	CSLD State Change																							
<p>Tank 1 : * PRODUCT1 Probe Serial Number : 78643211</p> <table style="width: 100%; border-collapse: collapse;"> <tr><td style="width: 20%;">11/04/2007 08:13:37 AM</td><td>Warning</td></tr> <tr><td>11/03/2007 05:11:31 PM</td><td>Pass</td></tr> <tr><td>11/02/2007 08:08:00 PM</td><td>No Results Available</td></tr> </table> <p>Tank 2 : * PRODUCT2 Probe Serial Number : 78643212</p> <table style="width: 100%; border-collapse: collapse;"> <tr><td style="width: 20%;">11/05/2007 11:17:47 AM</td><td>Fail</td></tr> <tr><td>11/03/2007 11:10:33 AM</td><td>Warning</td></tr> <tr><td>11/02/2007 08:08:01 PM</td><td>No Results Available</td></tr> </table> <p>Tank 3 : * PRODUCT3 Probe Serial Number : 78643213</p> <table style="width: 100%; border-collapse: collapse;"> <tr><td style="width: 20%;">11/03/2007 05:11:35 PM</td><td>Warning</td></tr> <tr><td>11/02/2007 08:08:02 PM</td><td>No Results Available</td></tr> </table> <p>Tank 4 : * PRODUCT4 Probe Serial Number : 78643214</p> <table style="width: 100%; border-collapse: collapse;"> <tr><td style="width: 20%;">11/05/2007 08:17:51 AM</td><td>Fail</td></tr> </table>							11/04/2007 08:13:37 AM	Warning	11/03/2007 05:11:31 PM	Pass	11/02/2007 08:08:00 PM	No Results Available	11/05/2007 11:17:47 AM	Fail	11/03/2007 11:10:33 AM	Warning	11/02/2007 08:08:01 PM	No Results Available	11/03/2007 05:11:35 PM	Warning	11/02/2007 08:08:02 PM	No Results Available	11/05/2007 08:17:51 AM	Fail
11/04/2007 08:13:37 AM	Warning																							
11/03/2007 05:11:31 PM	Pass																							
11/02/2007 08:08:00 PM	No Results Available																							
11/05/2007 11:17:47 AM	Fail																							
11/03/2007 11:10:33 AM	Warning																							
11/02/2007 08:08:01 PM	No Results Available																							
11/03/2007 05:11:35 PM	Warning																							
11/02/2007 08:08:02 PM	No Results Available																							
11/05/2007 08:17:51 AM	Fail																							
						Select Range																		
 All Tanks	 Tank 1	 Tank 2	 Tank 3	 Tank 4	 Tank 5	 Tank 6																		

The CSLD Monthly Diagnostics report displays the 0.2 gph (0.76 lph) CSLD tests for the current or previous month with state changes for each test. The default view is all tanks for the current month.

Siphon manifolded tanks are treated as one tank in CSLD. The tanks in the manifolded set share the same table and results. Deleting the table for any tank within the set will in effect delete the table of all the members in the set. All tank probe serial numbers will be listed in the report for siphon manifolded tanks.

You will only be able to access tanks that have CSLD enabled or have CSLD history.

### Report Column Descriptions

#### Date/Time

Value range: Date and Time

#### CSLD State Change

Possible results that will display in this column:

- Pass
- Fail
- Warning

- No results available
- Invalid
- Increase
- No idle data
- Active

## **CSLD Monthly Report Refresh Rate**

---

The CSLD Monthly Report data will be updated on change of state.

## **Control Buttons (on right of screen)**

---

### **Select Range**

Touch this button to setup the report's contents:

- **Select Option List** - Select data for report: All Records, Day, Week, Month, Year, Date Range
- **Period Option List** - Select period: Previous, Previous n selections
- **Select Tank(s)** - Select tank(s) to report: "All Tanks" or "Current Tank"

### **CSLD Test Setup**

Touch this button open the Tank Setup - CSLD Test Setup screen.

## **Regulatory Compliance**

---

Note: In-tank leak tests will not be declared a PASS unless the product level in the tank satisfies the minimum product level defined in our Third Party certification for the leak test being performed. In-tank leak tests performed with the product level below these minimum levels will be declared Invalid. Because the minimum product level requirements vary with local, state, and federal regulations, you need to ensure that the product level complies with the applicable regulations in your location.

## Tank Test Diagnostics - SLD Last Test

11/06/2007 05:30 PM		T 3: SETUP DATA WARNING	?				
Tank Test Diagnostics - SLD Last Test Results						All Tanks	
CSLD Monthly		SLD Last Test	SLD In Progress	SLD History	◀ ▶		
Test Type	Start Time	Test Result	Reason	Leak Rate	Hours	Tank Volume	
Tank 1 : * Regular							
Annual	11/05/2007 05:32 PM	Pass		0.00	8.0	5000.0	
Periodic	11/05/2007 05:32 PM	Pass		0.00	8.0	5000.0	
Gross	11/05/2007 05:32 PM	Pass		0.00		5000.0	
Tank 2 : * Midgrade East							
Annual	11/05/2007 05:32 PM	Fail		-0.10	8.0	4999.9	
Periodic	11/05/2007 05:32 PM	Pass		-0.10	8.0	4999.9	
Gross	11/05/2007 05:32 PM	Pass		-0.10		4999.9	
Tank 3 : * Super East							
Annual	11/05/2007 05:32 PM	Fail		-0.20	8.0	4999.9	
Periodic	11/05/2007 05:32 PM	Fail		-0.20	8.0	4999.9	
Gross	11/05/2007 05:32 PM	Pass		-0.20		4999.9	
Tank 4 : * Regular West							
Annual	11/05/2007 05:32 PM	Fail		-2.97	8.0	4998.5	
Periodic	11/05/2007 05:32 PM	Fail		-2.97	8.0	4998.5	
Gross	11/05/2007 05:32 PM	Fail		-2.97		4998.5	
All Tanks		Tank 1		Tank 2		Tank 3	
Tank 4		Tank 5		Tank 6		◀ ▶	
						▲	
						▼	

The SLD Last Test screen is a report showing the most recently completed SLD test results for all tanks or a specific tank. NOTE: Tanks must have the SLD Environmental Test Method enabled.

### Report Column Descriptions

The SLD Last Test report columns contain the following information depending on test results:

#### Test Type

Annual, Gross, or Periodic

#### Start Time

Date and time test started

#### Test Result

Pass, Fail, or Invalid

#### Reason

The possible messages that will display in this column are:



## TLS-450 Setup and Operation Screens Manual

- Head Temp Chg (probe head temperature changed too much)
- Insuf Smpl on First Per (insufficient TLS samples In first period)
- Insuf Smpl on Last Per (insufficient TLS samples In last period)
- Invalid Fuel Level (insufficient separation between fuel and water floats)
- Percent Vol Too Low (tank volume too low)
- Product Level Increase (leak rate is excessively positive)
- Recent Delivery (test started too soon after delivery)
- SLD Float size too small (fuel float diameter too small)
- SLD Low Level Err (fuel Level too low to temperature compensate)
- SLD Probe Incapable of Test (probe doesn't support test)
- Temp Chg (average fuel temperature changed too much)
- Temp out of Range (one or more in-fuel thermistors out of range)
- Test too Short (test too short)
- Zone Temp Chg (one or more in-fuel thermistors changed too much)

### Leak Rate

Value range: -26.42 to 26.42 gal (-99.99 to 99.99 L)

### Hours

Value range: 0.0 to 24.0 (blank for gross test)

### Tank Volume

Value range: 0.0 to 264,172.0 gal (0.0 to 999,999.0 L)

## Control Buttons (right of screen)

---



Touch this button to open the Tank Setup - SLD Test Setup screen

### Manual Test

Touch this button to access the Manual Static Leak Detect screen to start a SLD test.

## Regulatory Compliance

---

Note: In-tank leak tests will not be declared a PASS unless the product level in the tank satisfies the minimum product level defined in our Third Party certification for the leak test being performed. In-tank leak tests performed with the product level below these minimum levels will be declared Invalid. Because the minimum product level requirements vary with local, state, and federal regulations, you need to ensure that the product level complies with the applicable regulations in your location.

## Tank Test Diagnostics - SLD In-Progress

11/06/2007 05:31 PM		T 2: SETUP DATA WARNING														
Tank Test Diagnostics - SLD Test In-Progress						All Tanks										
CSLD Monthly	SLD Last Test	SLD In Progress	SLD History													
<p><b>Tank 1 : * Regular</b>                  Status: OFF      Test Type: 0.1 Gal/Hr                  Result: Pass                  Reason:                  Start Time: 11/05/2007 05:32 PM      Duration: 8.0 Hrs                  Start Temp: 60.0 °F      Leak Rate: 0.00 gal/Hr                  Ending Temp: 60.0 °F      Threshold: 0.07 gal/Hr                  Start Volume: 5000.0 gal      Fuel Height: 50.0 in                  Percent Volume: 50.0 %      Water Height: 0.0 in                  Cumulative Periodic Volume Change (Gal):                  0.00 0.00 0.00 0.00 0.00 0.00 0.00 0.00 0.00 0.00 0.00 0.00 0.00 0.00</p> <p><b>Tank 2 : * Midgrade East</b>                  Status: OFF      Test Type: 0.1 Gal/Hr                  Result: Fail                  Reason:                  Start Time: 11/05/2007 05:32 PM      Duration: 8.0 Hrs                  Start Temp: 60.0 °F      Leak Rate: -0.10 gal/Hr                  Ending Temp: 60.0 °F      Threshold: 0.07 gal/Hr                  Start Volume: 4999.9 gal      Fuel Height: 50.0 in                  Percent Volume: 49.0 %      Water Height: 0.0 in</p>						Manual Test										
						<table style="width: 100%; border: none;"> <tr> <td style="text-align: center;"> All Tanks</td> <td style="text-align: center;"> Tank 1</td> <td style="text-align: center;"> Tank 2</td> <td style="text-align: center;"> Tank 3</td> <td style="text-align: center;"> Tank 4</td> <td style="text-align: center;"> Tank 5</td> <td style="text-align: center;"> Tank 6</td> <td style="width: 10%; text-align: center;"></td> <td style="width: 10%; text-align: center;"></td> <td style="width: 10%; text-align: center;"></td> <td style="width: 10%; text-align: center;"></td> </tr> </table>						All Tanks	Tank 1	Tank 2	Tank 3	Tank 4
All Tanks	Tank 1	Tank 2	Tank 3	Tank 4	Tank 5	Tank 6										

The SLD In-Progress report will display any SLD tests that are currently active, or in-progress. This screen will be refreshed every 30 seconds.

The Status field will indicate if a SLD test is not active for the currently selected tank(s). All field values are displayed after the first period of the test (15 minutes for gross tests or 30 minutes for precision tests).

Tanks must have SLD enabled and be configured with a probe that supports leak detection to be visible in this report.

### Report Column Descriptions

#### Status

If there is no active SLD test, Off will be displayed in the data view for the selected tank. The status field shows Off if the test is completed (shows result of last test), else if test is active, the status field shows On.

Value range: Status of tanks under test, e.g., T 1: ON, T 2: OFF

**Test Type**

Value range: 0.1 gal/hr Test (0.38 L/hr Test), 0.2 gal/hr. Test (0.76 L/hr Test)

**Result**

Possible messages:

- Invalid
- Pass
- Fail (may be blank)

**Reason**

More than one reason may be displayed in a comma separated list. The reasons may change as the test progresses.

The possible messages that will display in this column are:

- Head Temp Chg (probe head temperature changed too much)
- Insuf Smpl on First Per (insufficient TLS samples In first period)
- Insuf Smpl on Last Per (insufficient TLS samples In last period)
- Invalid Fuel Level (insufficient separation between fuel and water floats)
- Percent Vol Too Low (tank volume too low)
- Product Level Increase (leak rate is excessively positive)
- Recent Delivery (test started too soon after delivery)
- SLD Float size too small (fuel float diameter too small)
- SLD Low Level Err (fuel Level too low to temperature compensate)
- SLD Probe Incapable of Test (probe doesn't support test)
- Temp Chg (average fuel temperature changed too much)
- Temp out of Range (one or more in-fuel thermistors out of range)
- Test too Short (test too short)
- Zone Temp Chg (one or more in-fuel thermistors changed too much)

**Start Time**

Value range: Date/Time

**Duration**

Value range: 0 - 24 hours (blank for gross test)

**Start Temp**

Value range: -40.0 to 140.0°F (-40.0 to 60.0°C)

**Leak Rate**

Value range: -26.417 to 26.417 gal (-99.999 to 99.999L)

**End Temp**

Value range: -40.0 to 140.0°F (-40.0 to 60.0°C)

**Threshold**

Value range: 0.00 to 9.99 gal (0.00 to 37.82L)

**Start Volume**

Value range: 0 to 264,172 gal (0 to 999,999L)

**Fuel Height**

Value range: 0 to 390.0 in. (0 to 9906.0mm)

**Percent Volume**

Value range: 0.0 to 100.0

**Water Height**

Value range: 0 to 390.0 in. (0 to 9906.0mm)

**Cumulative Periodic Volume Change**

There is one Cumulative Periodic Volume Change field for each completed one half hour of test duration, up to 47 fields maximum. The fields will be displayed in rows of ten fields maximum.

Value range: -26.41 to 26.41 gal (-99.99 to 99.99L)

---

**SLD Test In-Progress Report Refresh Rate**

The SLD Test In-Progress Report data will be refreshed every 30 seconds.

---

**Test Control Buttons (on right of screen)**



Touch this button to open the Tank Setup - SLD Test Setup screen.

**Manual Test**

Touch this button to open the Manual Static Leak Detect screen to start or stop a SLD test.

---

**Regulatory Compliance**

Note: In-tank leak tests will not be declared a PASS unless the product level in the tank satisfies the minimum product level defined in our Third Party certification for the leak test being performed. In-tank leak tests performed with the product level below these minimum levels will be declared Invalid. Because the minimum product level requirements vary with local, state, and federal regulations, you need to ensure that the product level complies with the applicable regulations in your location.

## Manual Static Leak Detect screen

11/07/2007 11:48 AM		T 4: HIGH WATER WARNING				
Tank Test Diagnostics – Manual Static Leak Detect						Tank 1 : PRODUCT 1
Tests Running	T 1 : Off					Start
Test Control	Manual Stop					Stop
Test Rate[Gal/Hr]	0.2 gal/hr					Start All Tanks
						Stop All Tanks
 Tank 1						

This screen displays when you touch the Manual Test button from any of the Tank Test Diagnostic SLD screens. You select all parameters necessary to start an SLD test using this dialog. This dialog allows you to start or stop an SLD test for All Tanks or a single tank.

Notes:

1. The Test Control, Test Rate, and Test Duration fields will be disabled when an SLD Test is active.
2. Tank tests will unavailable for tanks that do not have SLD enabled, have an un-configured probe, or are configured with a probe that does not support leak detection.

### Test Running

Tests Running is a read-only field. The field will display the Tanks (i.e. T1, T2, T3, T4) that are currently under an SLD test. If a test starts or stops due to automatic Scheduling, the Tests Running field will update to reflect the current status. The Tests Running field will update immediately when a test is stopped or a test completes.

### Test Control

Allowable selections: Timed duration, Manual Stop  
Default: Timed duration

**Test Rate**

Allowable selections: 0.1 gal/hr (0.38 ltr/hr), 0.2 gal/hr (0.76 ltr/hr)  
Default: 0.2 gal/hr

**Test Duration**

The Test Duration field will be present only when the Test Control is set to Timed Duration.

Allowable selections: 2 - 24 hours  
Default: 2 hours

**Test Control Buttons (on right of screen)**

---

**Start**

Touch this button to start a manual test of a selected tank. This button is disabled if tests are running for the currently selected tank, or if Start All Tanks is selected to start tests for all tanks.

**Stop**

Touch this button to stop a manual test of a selected tank. This button is disabled if test are not running for the currently selected tank, or if Stop All Tanks is selected to stop tests for all tanks.

**Start All Tanks**

Touch this button to start an SLD test for all tanks using the field selections for an individual tank.

**Stop All Tanks**

Touch this button to stop all SLD tests that are running.

## Tank Test Diagnostics - SLD History

11/06/2007 05:31 PM		T 5: SETUP DATA WARNING	?					
Tank Test Diagnostics - SLD History						All Tanks		
CSLD Monthly		SLD Last Test	SLD In Progress	SLD History			Manual Test	
Test Type	Date & Time	Test Result	Hours	Leak Rate	Tank Volume	% Volume	Select Range	
Tank 1 : * Regular								
Annual	11/05/2007 05:32 PM	Pass	8.0	0.00	5000	50.5		
Periodic	11/05/2007 05:32 PM	Pass	8.0	0.00	5000	50.5		
Gross	11/05/2007 05:32 PM	Pass	8.0	0.00	5000	50.5		
Tank 2 : * Midgrade East								
Annual	11/05/2007 05:32 PM	Fail	8.0	-0.10	4999	49.9		
Periodic	11/05/2007 05:32 PM	Pass	8.0	-0.10	4999	49.9		
Gross	11/05/2007 05:32 PM	Pass	8.0	-0.10	4999	49.9		
Tank 3 : * Super East								
Annual	11/05/2007 05:32 PM	Fail	8.0	-0.20	4999	49.9		
Periodic	11/05/2007 05:32 PM	Fail	8.0	-0.20	4999	49.9		
Gross	11/05/2007 05:32 PM	Pass	8.0	-0.20	4999	49.9		
Tank 4 : * Regular West								
Annual	11/05/2007 05:32 PM	Fail	8.0	-2.97	4998	49.9		
Periodic	11/05/2007 05:32 PM	Fail	8.0	-2.97	4998	49.9		
Gross	11/05/2007 05:32 PM	Fail	8.0	-2.97	4998	49.9		
Tank 5 : * Mid-grade West								
Tank 6 : * Super West								
All Tanks	Tank 1	Tank 2	Tank 3	Tank 4	Tank 5	Tank 6		

The SLD history screen displays the recent 10 (Pass or Fail) records of gross test and all Pass and Fail records of precision tests. Invalid results are not displayed in this screen.

Tanks must have SLD enabled and be configured with a probe that supports leak detection to be visible in this report.

### Report Column Descriptions

#### Test Type

Value range: Annual, Gross, Periodic

#### Date & Time

Value range: Date/Time

#### Test Result

Value range: Pass, Fail

**Hours**

Value range: 0.0 to 24.0 (blank for Gross test)

**Leak Rate**

Value range: -26.42 to 26.42 gal/hour (-99.99 to 99.99L/hour)

**Tank Volume**

Value range: 0 to 264,172gal (0 to 999,999L)

**%Volume**

Value range: 0.0 to 100.0

**SLD History Report Refresh Rate**

---

The SLD History Report data will be refreshed every 30 seconds.

**Control Buttons (right of screen)**

---

**Setup**

Touch this button to open the Tank Setup - SLD Test Setup screen

**Manual Test**

Touch this button to access the Manual Static Leak Detect screen in which you can start a SLD test.

**Select Range**

Touch this button to setup the report's contents:

- **Select Option List** - Select data for report: All Records, Day, Week, Month, Year, Date Range
- **Period Option List** - Select period: Previous, Previous n selections
- **Select Tank(s)** - Select tank(s) to report: "All Tanks" or "Current Tank"

**Regulatory Compliance**

---

Note: In-tank leak tests will not be declared a PASS unless the product level in the tank satisfies the minimum product level defined in our Third Party certification for the leak test being performed. In-tank leak tests performed with the product level below these minimum levels will be declared Invalid. Because the minimum product level requirements vary with local, state, and federal regulations, you need to ensure that the product level complies with the applicable regulations in your location.



## Pumps and Lines

### PLLD Diagnostics - Manual Test

11/06/2007 05:48 PM		All Functions Normal				
PLLD Diagnostics - Manual Test						All Lines
Manual Test	PLLD Status	3.0 gph Tests	Mid-Range Tests	Next	Previous	Start
Test						Stop
		3.0				
Test	Manual Test Status	PLLD Test Status				
Line 1 : PRESSURE LLD #1		Test Complete				
Line 2 : PRESSURE LLD #2		Test Complete				
Line 3 : PRESSURE LLD #3		Test Complete				
Line 4 : PRESSURE LLD #4		Test Complete				
Line 5 : PRESSURE LLD #5		Test Complete				
Line 6 : PRESSURE LLD #6		Test Complete				
All Lines	Line 1	Line 2	Line 3	Line 4	Line 5	Line 6

The PLLD Diagnostics Manual Test screen lets you select all parameters necessary to start or stop PLLD tests (3.0 gph (11.3 lph), 0.2 gph (0.76 lph) or 0.1 gph (0.38 lph)) for individual lines or all lines at once.

#### Test Notes

1. Tests always run in the order: 3.0 (11.3), 0.2 (0.76), and 0.1 (0.38).
2. Approximate test times, assuming no dispense (which would restart the test(s) after the dispense) and no thermals, are 3.0 (11.3) - several minutes, 0.2 (0.76) - 30 minutes, and 0.1 (0.38) - 45 minutes.
3. A 3.0 (11.3) test runs that test only.
4. A 0.2 (0.76) test is automatically preceded by a 3.0 (11.3) test. Selecting a 0.2 (0.76) test bypasses the '0.2 (0.76) Line Test Auto-Confirm' PLLD setup selection (if enabled).
5. A 0.1 (0.38) test is automatically preceded by 3.0 (11.3) and 0.2 (0.76) tests. Selecting a 0.1 (0.38) test bypasses the '0.2 (0.76) Line Test Auto-Confirm' and '0.1 (0.38) Line Test Auto-Confirm' PLLD setup selections (if enabled).

## **Report Column Descriptions**

---

### **Test**

Value range: 0.1 (0.38), 0.2 (0.76), 3.0 (11.3)

### **Test Status**

Possible messages include:

- Queued (a test is pending)
- In-progress (a test is in progress)

### **PLLD Test Status**

Possible messages include:

- Disable Alarm (one of the PLLD pump disable alarms is active)
- Dispensing (product is being dispensed)
- Line Lockout (console is in a line lockout period)
- Pressure Check (checking for high pressure after a 3.0 gph (11.3 lph) test)
- Running Pump (the pump is running at the beginning of a test)
- Test Aborted (the test has aborted)
- Test Complete (the test has finished running)
- Test Delay (test is scheduled to run but it is in a delay state [usually after a line dispense])
- Test Pending (test is scheduled to run)
- 0.1 (0.38) (a 0.1 [0.38] test is in progress)
- 0.2 (0.76) (a 0.2 [0.76] test is in progress)
- 3.0 (11.3) (a 3.0 [11.3] test is in progress)

## **PLLD Manual Test - Refresh Rate**

---

The PLLD Manual Test screen is updated for every 30 seconds for change of test or line state.

## **Test Control Buttons (on right of screen)**

---

### **Start**

Touch this button to start a manual test of all lines (or an Individual Line) for the selected Test - see notes below.

1. When a test is started for a line, the Test Type will become 'Manual' and the selected test will show up in the Test column. The Test Status and Line Status will show the corresponding statuses as the test runs until it is complete or it is aborted. The 0.2 (0.76) and 0.1 (0.38) tests can be started if they have been enabled in PLLD Setup. The 3.0 (11.3) test is always available when the PLLD feature has been enabled for a line.
2. When the Start Button is pressed for the selected test, any tests that are currently in progress (Manual or Automatic) will be re-started (from the very beginning as Manual).

### **Stop**

Touch this button to stop a manual test of all lines (or an Individual Line). Note - When a test is stopped for a line, the Test Type will become blank and the Test will become blank. The Test and PLLD Test Statuses will show the status of the test and line as the test stops.

## PLLD Diagnostics - PLLD Status

11/06/2007 05:48 PM				All Functions Normal									
PLLD Diagnostics - PLLD Status										All Lines			
Manual Test		PLLD Status		3.0 gph Tests		Mid-Range Tests		N					
#	Label	Dispensing	Test Status	Pump	Handle	Pressure							
Q 1	PRESSURE LLD #1	Enabled	Test Complete	Off	Off	0.000							
Q 2	PRESSURE LLD #2	Enabled	Test Complete	Off	Off	0.000							
Q 3	PRESSURE LLD #3	Enabled	Test Complete	Off	Off	0.000							
Q 4	PRESSURE LLD #4	Enabled	Test Complete	Off	Off	0.000							
Q 5	PRESSURE LLD #5	Enabled	Test Complete	Off	Off	0.000							
Q 6	PRESSURE LLD #6	Enabled	Test Complete	Off	Off	0.000							

The PLLD Diagnostics screen displays a report with PLLD status information on all lines with PLLD.

### Report Column Descriptions

#### # (PLLD line identifier)

Device code followed by 1 to 32 (e.g., Q1)

#### Label (PLLD line label)

Label (assigned in setup)

#### Dispensing (flag)

Enabled, Disabled

#### Test Status

Possible messages include:

- Disable Alarm
- Dispensing
- Line Lockout (console is in a line lockout period)
- Pressure Check (checking for high pressure after a 3.0 gph [11.3 lph] test)
- Running Pump
- Test Aborted

## TLS-450 Setup and Operation Screens Manual

- Test Complete
- Test Delay
- Test Pending
- Testing at 0.1 (0.38)
- Testing at 0.2 (0.76)
- Testing at 3.0 (11.3)

### **Pump (state)**

On, Off

### **Handle (state)**

On, Off

### **Pressure (measured on line)**

Value range: -14.000 to 99.999 psi (-96.485 to 689.173kPa)

## **PLLD Status - Refresh Rate**

---

The PLLD Status screen will be refreshed every 4 seconds.

## **Control Buttons (right of screen)**

---

### **Setup**

Touch this button to open the PLLD Setup ['Pump and Line Setup - PLLD' screen](#).



### **Diagnostics (line pressure sensor)**

Touch this button to open the [LPR Diagnostics - Communication screen](#).

## PLLD Diagnostics - 3.0 gph (11.3lph) Test Results

11/06/2007 05:49 PM		All Functions Normal				
PLLD Diagnostics - 3.0 gph Test Results						All Lines
Manual Test	PLLD Status	3.0 gph Tests	Mid-Range Tests			
Date/Time	Pump On	First Read	Second Read	Status		
<b>Line 1 : PRESSURE LLD #1</b>						
11/01/2007 01:24 PM	39.0	20.0	20.0	Pass		
11/01/2007 12:27 PM	39.1	20.0	20.0	Pass		
11/01/2007 12:23 PM	40.0	20.0	20.0	Pass		
11/01/2007 11:51 AM	39.5	20.0	20.0	Pass		
11/01/2007 11:48 AM	40.0	20.0	20.0	Pass		
<b>Line 2 : PRESSURE LLD #2</b>						
11/01/2007 01:24 PM	39.4	20.0	20.0	Pass		
11/01/2007 12:27 PM	39.7	20.0	20.0	Pass		
11/01/2007 12:23 PM	40.0	20.0	20.0	Pass		
11/01/2007 11:52 AM	39.7	20.0	20.0	Pass		
11/01/2007 11:48 AM	40.0	20.0	20.0	Pass		
<b>Line 3 : PRESSURE LLD #3</b>						
11/01/2007 01:25 PM	39.7	20.0	20.0	Pass		
11/01/2007 12:28 PM	39.9	20.0	20.0	Pass		
11/01/2007 12:24 PM	40.0	20.0	20.0	Pass		
All Lines	Line 1	Line 2	Line 3	Line 4	Line 5	Line 6

The PLLD Diagnostics - 3.0 gph (11.3 lph) Tests screen displays a report with the last five 3.0 gph (11.3 lph) test results (including passed and failed tests) for all lines with PLLD.

### Report Column Descriptions

#### Date/Time

The Date and Time of the test.

#### Pump On

The pressure reading when turning On the pump.

Value range: -14.0 to 99.9 psi (-96.5 to 689.2kPa)

#### First Read

The first pressure reading of the 3.0 (11.3) test.

Value range: -14.0 to 99.9 psi (-96.5 to 689.2kPa)

## **Second Read**

The second pressure reading of the 3.0 (11.3) test.

Value range: -14.0 to 99.9 psi (-96.5 to 689.2kPa)

## **Status**

Possible messages:

- Pass
- Fail
- High Pressure

## **Control Buttons (right of screen)**

---



Touch this button to open the PLLD Setup ['Pump and Line Setup - PLLD' screen](#).



## **Diagnostics (line pressure sensor)**

Touch this button to open the [LPR Diagnostics - Communication screen](#).

## PLLD Diagnostics - Mid-Range Test Results

11/06/2007 05:50 PM		T 2: HIGH WATER WARNING				
PLLD Diagnostics - Mid Range Test Results						All Lines
Manual Test	PLLD Status	3.0 gph Tests	Mid-Range Tests			
Date/Time	Pump On	First Read	Second Read	Status		
<b>Line 1 : PRESSURE LLD #1</b>						
11/01/2007 01:55 PM	39.0	20.0	20.0	Pass		
11/01/2007 12:58 PM	39.1	20.0	20.0	Pass		
<b>Line 2 : PRESSURE LLD #2</b>						
11/01/2007 01:56 PM	39.4	20.0	20.0	Pass		
11/01/2007 12:59 PM	39.7	20.0	20.0	Pass		
<b>Line 3 : PRESSURE LLD #3</b>						
11/01/2007 01:57 PM	39.7	20.0	20.0	Pass		
11/01/2007 01:00 PM	39.9	20.0	20.0	Pass		
<b>Line 4 : PRESSURE LLD #4</b>						
11/01/2007 01:59 PM	39.8	20.0	20.0	Pass		
11/01/2007 01:02 PM	39.9	20.0	20.0	Pass		
<b>Line 5 : PRESSURE LLD #5</b>						
11/01/2007 02:00 PM	39.9	20.0	20.0	Pass		
11/01/2007 01:03 PM	39.9	20.0	20.0	Pass		
<b>Line 6 : PRESSURE LLD #6</b>						
All Lines	Line 1	Line 2	Line 3	Line 4	Line 5	Line 6

The PLLD Diagnostics - Mid-Range Tests screen displays a report with the last five mid-range test results (including passed and failed tests) for all lines with PLLD.

### Report Column Descriptions

#### Date/Time

Value range: The Date and Time of the test.

#### Pump On

The pressure reading when turning On the pump.

Value range: -14.0 to 99.9 psi (-96.5 to 689.2kPa)

#### First Read

The first pressure reading of the Mid-Range test.

Value range: -14.0 to 99.9 psi (-96.5 to 689.2kPa)

## **Second Read**

The second pressure reading of the Mid-Range test.

Value range: -14.0 to 99.9 psi (-96.5 to 689.2kPa)

## **Status**

Possible messages:

- Pass
- Fail

## **Control Buttons (right of screen)**

---



Touch this button to open the PLLD Setup ['Pump and Line Setup - PLLD' screen](#).



## **Diagnostics (line pressure sensor)**

Touch this button to open the [LPR Diagnostics - Communication screen](#).



## PLLD Diagnostics - No-Vent Aborts

11/06/2007 05:50 PM			T 4: HIGH WATER WARNING						
PLLD Diagnostics - No-Vent Test Aborts								All Lines	
3.0 gph Tests		Mid-Range Tests		No-Vent Aborts		0.2 gph Tests			
#	Label	Test Aborts	Total Tests						
Q 1	PRESSURE LLD #1	1	4						
Q 2	PRESSURE LLD #2	0	2						
Q 3	PRESSURE LLD #3	0	2						
Q 4	PRESSURE LLD #4	0	2						
Q 5	PRESSURE LLD #5	0	2						
Q 6	PRESSURE LLD #6	0	2						
Q 7		0	0						
Q 8		0	0						

The No-Vent Test Aborts Tab of the PLLD Diagnostics interface displays a report with No-Vent Test Aborts information about all lines with PLLD in the system.

This screen will only be available if the 0.2 gph (0.76 lph) or 0.1 gph (0.39 lph) line leak test features are available.

### Report Column Descriptions

**# (PLLD line identifier)**

Device code followed by 1 to 32 (e.g., Q1)

**Label (PLLD line label)**

Label (assigned in setup)

**Test Aborts**

Number of Tests that were aborted because of a 'No-Vent' failure.

Value range: 0 - 99

**Total Tests**

Number of total tests run.

Value range: 0- 99

**Control Buttons (right of screen)**

---



Touch this button to open the PLLD Setup ['Pump and Line Setup - PLLD' screen](#).



Touch this button to open the [LPR Diagnostics - Communication screen](#).

## PLLD Diagnostics - 0.2 gph (0.76 lph) Test Results

Date/Time	Pump On	Ratio	Duration	Results
<b>line 1: PRESSURE LLD#1</b>				
11/01/2009 01:55 PM	38.3	0.50	0:31	PASS
11/01/2009 01:55 PM	38.9	0.29	0:31	PASS

The PLLD Diagnostics 0.2 gph (0.76 lph) Tests screen displays a report with the last five 0.2 gph (0.76 lph) test results (including passed and failed tests) for all lines with PLLD.

This screen will only be available if the 0.2 Line Leak Test feature is available.

### Report Column Descriptions

#### Date/Time

The Date and Time of the test.

#### Pump On

The pressure reading when turning On the Pump.

Value range: -14.0 to 99.9 psi (-96.5 to 689.2kPa)

**Ratio**

Pump On Ratio = Ramp/Fail threshold (>1.0 = Fail and <1.0 = Pass) and is used to indicate how close the test is to fail the threshold. Large variations in ratio indicate an intermittent problem such as the valve not always seating properly.

Value range: 0.00 to 99.99

**Duration**

Test Duration in hours and fraction of an hour in minutes. Long durations indicate there was a lot of thermal activity during the test.

Value range: HH:MM (where HH = 0 to 99, MM = 0 to 59)

**Results**

The results of the test.

Possible messages:

- Pass
- Fail

**Control Buttons (right of screen)**

---



Touch this button to open the PLLD Setup ['Pump and Line Setup - PLLD' screen](#).



Touch this button to open the [LPR Diagnostics - Communication screen](#).

## PLLD Diagnostics - 0.1 gph (0.38lph) Test Results

Date/Time	Pump On	Ratio	Duration	Results
Line 1: PRESSURE LLD#1 11/02/2009 01:15 PM	39.0	0.72	0:16	PASS

The PLLD Diagnostics 0.1 gph (0.38 lph) Tests screen displays a report with the last five 0.1 gph (0.38 lph) test results (including passed and failed tests) for all lines with PLLD.

This screen will only be available if the 0.1 Line Leak Test feature is available.

### Report Column Descriptions

#### Date/Time

The Date and Time of the test.

#### Pump On

The pressure reading when turning On the Pump.

Value range: -14.0 to 99.9 psi (-96.5 to 689.2kPa)

**Ratio**

Pump On Ratio = Ramp/Fail threshold (>1.0 = Fail and <1.0 = Pass) and is used to indicate how close the test is to fail the threshold. Large variations in ratio indicate an intermittent problem such as the valve not always seating properly.

Value range: 0.00 to 99.99

**Duration**

Test Duration in hours and fraction of an hour in minutes. Long durations indicate there was a lot of thermal activity during the test.

Value range: HH:MM (where HH = 0 to 99, MM = 0 to 59)

**Results**

The results of the test.

Possible messages:

- Pass
- Fail

**Control Buttons (right of screen)**

---



Touch this button to open the PLLD Setup ['Pump and Line Setup - PLLD' screen](#).



**Diagnostics (line pressure sensor)**

Touch this button to open the [LPR Diagnostics - Communication screen](#).

# Tank

## Tank Diagnostics - 30 Second Inventory Samples

07/28/2008  
02:44 PM

Ln 2: LINE OUT

Tank Diagnostics - 30 Second Inventory Samples

Tank 1 : REGULAR

30 Second Inventory Samples

Date/Time	Samples	Volume	Height	Avg Temp	Top Temp	Bd Temp
<b>Tank 1 : REGULAR(Volume is TC)</b>						
07/28/2008 02:43:43 PM	30	2694.08	32.655	59.99	60.00	60.00
07/28/2008 02:43:13 PM	30	2693.99	32.654	59.99	60.00	60.00
07/28/2008 02:42:43 PM	30	2694.03	32.655	59.99	60.00	60.00
07/28/2008 02:42:13 PM	30	2693.99	32.654	59.99	60.00	60.00
07/28/2008 02:41:43 PM	30	2694.05	32.655	59.99	60.00	60.00
07/28/2008 02:41:13 PM	30	2694.03	32.655	59.99	60.00	60.00
07/28/2008 02:40:43 PM	30	2694.07	32.655	59.99	60.00	60.00
07/28/2008 02:40:13 PM	30	2693.99	32.654	59.99	60.00	60.00
07/28/2008 02:39:43 PM	30	2694.07	32.655	59.99	60.00	60.00
07/28/2008 02:39:13 PM	30	2693.95	32.654	59.99	60.00	60.00
07/28/2008 02:38:43 PM	30	2693.95	32.654	59.99	60.00	60.00
07/28/2008 02:38:13 PM	30	2693.93	32.654	59.99	60.00	60.00
07/28/2008 02:37:43 PM	30	2693.97	32.654	59.99	60.00	60.00
07/28/2008 02:37:13 PM	30	2694.08	32.655	59.99	60.00	60.00
07/28/2008 02:36:43 PM	30	2694.03	32.655	59.99	60.00	60.00

Tank 1

Tank 2

Tank 3

The Tank Diagnostics 30 Second Samples report is a Moving Average Table. It is used to diagnose problems with several console features, such as CSLD, ISD, etc. This report shows the last 46 inventory samples.

For the All Tanks view, if some probes measure temperature and others do not, The Avg Temp, Top Temp, and Bd Temp columns will still be visible, but the field will be left blank if the temperature is not available.

### Report Column Descriptions

---

**Date/Time**

Value range: Date and Time

**Samples**

Value range: 1-99

264

**Volume**

The volume field is temperature compensated volume if the probe has temperature measurement capability. If the probe cannot measure temperature or the TLS does not support temperature compensation, the standard volume will be displayed.

Value range: 0.00 to 264,172.00 gal (0.00 to 999,999.99L)

**Height**

Value range: 0 to 390.000 in. (0 to 9906.000mm)

**Avg. Temp**

Value range: -40.00 to 140.00°F (-40.00 to 60.00°C)

**Top Temp**

Value range: -40.00 to 140.00°F (-40.00 to 60.00°C)

**Bd Temp**

Value range: -40.00 to 140.00°F (-40.00 to 60.00°C)

**30 Second Inventory Samples Refresh Rate**

---

The 30 Second Inventory Samples screen will be refreshed every 30 seconds.



## Meter

### Meter Diagnostics - Meter Events

03/08/2010 10:04 AM		Ln 1: SETUP DATA WARNING								
Meter Diagnostics - Meter Events										Clear All
Meter Events	Tank Map	Manual Mapping								
Date & Time	Fuel Position	Meter	User FP	Event Type	Transaction Volume					

The Meter Events screen lists up to one page of time-ordered meter start/stop events.

**Date & Time**

Date/time of start or stop meter event.

**Fuel Position**

Fueling position reported by the POS terminal.

**Meter**

Meter number reported by the POS terminal.

**User FP**

Fuel position as labeled by the station operator.

**Event Type**

POS reported meter events as they occurred in time, prefixed by Start or Stop as applicable.

**Transaction Volume**

Volume dispensed as reported by the POS terminal with stopped meter event.

**Control Button (Right side of Screen)**

---

**Clear All**

The Clear All button is only enabled when at least one record is available. Touch this button to clear all meter events from screen.

## Meter Diagnostics - Tank Map

03/08/2010 10:04 AM				M 1: SETUP DATA WARNING							
Meter Diagnostics - Tank Map											Edit
Meter Events			Tank Map		Manual Mapping						Lock All
Source	User FP	Real FP	Real Meter	Tank/Blend		Locked	Last Report Time				Unlock All
											Clear All

This screen displays the meter-to-tank map. This is the screen you want to use to verify meter mapping, or to view if the site should go unmapped, suspending BIR.

**Source**

DIM module connected to reporting POS terminal.

**User FP**

Fuel position as labeled by the operator.

**Real FP**

Fuel position reported by the POS terminal.

**Real Meter**

Meter number reported by the POS terminal.

## **Tank/Blend**

Possible messages:

- Tank Label
- Blend Label
- Unmapped
- Probeless (unmonitored tanks, such as propane)
- R (retired) - If an unmapped meter has not been reported by a POS within 24 hours of the last report, the meter is declared 'retired'. A retired meter may be a phantom meter incorrectly reported by the POS, or it may be a seldom heard from meter, such as one connected to a kerosene tank. Until the 'retired' meter is mapped, every time the meter is activated, and for 24 hours thereafter, BIR is suspended.

## **Locked**

User has locked tank-to-meter mapping for this meter. Auto meter mapping will not change it.

## **Last Report Time**

Last transaction reported for this meter.

## **Control Buttons (Right side of screen)**

---

### **Edit**

This button is grayed out unless at least one record in the data view area is selected. When the desired record is highlighted, touch the Edit button to display the 'Edit Tank Map' - dialog box which is described below:

### **Edit Tank Map - Dialog Box**

The selected record will populate the appropriate fields in the 'Edit Tank Map' dialog. When the 'Tank Map' record has been edited using the 'Edit Tank Map' dialog, the new data will replace the old data in the selected record. The fields of the Edit Tank Map dialog are described below:

- **Locked** - The user can only lock an entry if it is mapped or probeless. Retired entries are unmapped, and cannot be locked. A Probeless tank assignment will be locked. You cannot unlock the meter assignment (the Locked field is inactive). Touch the Down arrow to select: Yes or No.
- **Tank/Blend** - Touch the Down arrow to select:
- **Tank Label**
- **Blend Label**
- **Unmapped** - Select this entry if the meter was incorrectly mapped and you want the automapping feature to correctly map the meter (This suspends BIR until the meters are all mapped).
- **Probeless** - Select this entry for meters from which the POS reports activity, but that are not monitored by the TLS, such as propane or kerosene.
- **User FP** - Touch the numeric keypad button to enter the desired fuel position. Allowable selections: 1 to 72
- **Real FP** - This field is read only and the entry is based on the selected Map Record.
- **Real Meter** - This field is read only and the entry is based on the selected Map Record.

**Lock All**

This button is grayed out unless at least one record is in the data view area. Touch this button to lock all entries in the tank map.

**Unlock All**

This button is grayed out unless at least one record is in the data view area. Touch this button to unlock all entries in the tank map.

**Clear All**

This button is grayed out unless at least one record is in the data view area. Touch this button to clear all entries in the data view area.

## Meter Diagnostics - Manual Mapping

03/08/2010 10:04 AM				Ln 1: SETUP DATA WARNING							
Meter Diagnostics - Manual Mapping										Edit	
Meter Events		Tank Map		Manual Mapping						Max Meas Volume	
Transaction Time	Source	Real FP	Real Meter	Volume	Tank/Blend		User FP	...	Clear All	More	

The Manual Mapping diagnostic screen will help you assign meters to tanks with small volume dispensing events and to identify post-blend metering. This screen displays active events as they are reported by the POS terminal.

### Report Column Descriptions

#### Transaction Time

Date/time of transaction.

#### Real FP

Fueling position reported by the POS terminal.

#### Real Meter

Meter number reported by the POS terminal.

#### Volume

This volume dispensed to manually map the meters you set in the 'Enter Max Meas. Volume' dialog box described below.

### **Tank/Blend**

Possible messages: Tank Label, Blend Label, Unmapped, Probeless or R (retired)

### **User FP**

Fuel position as labeled by the station operator.

### **Locked**

Possible messages: Yes or No. If yes, user has locked tank to meter mapping for this meter. Auto meter mapping will not change it.

## **Control Buttons (Right side of screen)**

---

### **Edit**

This button is grayed out unless at least one record in the data view area is selected. When the desired record is highlighted, touch the Edit button to display the 'Edit Tank Map' - dialog box which is described below.

### **Edit Tank Map - Dialog Box**



The selected record will populate the appropriate fields in the 'Edit Tank Map' dialog. When the 'Tank Map' record has been edited using the 'Edit Tank Map' dialog, the new data will replace the old data in the selected record. The fields of the Edit Tank Map dialog are described below:

- **Locked** - The user can only lock an entry if it is mapped or probeless. Retired entries are unmapped, and cannot be locked. A Probeless tank assignment will be locked. You cannot unlock the meter assignment (the Locked field is inactive). Touch the Down arrow to select: Yes or No
- **Tank/Blend** - Touch the Down arrow to select: Tank Label, Blend Label, Unmapped, Probeless or R (retired)
- **User FP** - Fuel position as labeled by the station operator. Allowable selections: 1 to 72
- **Real FP** - This field is read only - Fueling position reported by the POS terminal.
- **Real Meter** - This field is read only - Meter number reported by the POS terminal.

### **Max Meas. Volume**

Touching this button displays the 'Enter Maximum Measured Volume' - dialog described below:

**Volume** - Touch the numeric keypad to the right of the Volume field and enter a desired maximum measuring volume. This volume is the maximum allowed into the Manual Mapping screen. The normally higher dispenses associated with commercial transactions are filtered out while you are manually mapping meters. Allowable selections: 0 - 2.58 gal (0 to 10 litres).

Touch the  button to accept edited value or  button to abort the change and close the 'Enter Maximum Measured Volume' dialog box.

### **Clear All**

When at least one event record is visible in the data view area this button is active. Touch the Clear All button to remove all event records from the data view area.

### **More**

Touching the 'More' button will shift the report over (right or left) to reveal additional columns outside of the data view area.

## Reconciliation

### Reconciliation Diagnostics - Status

03/08/2010 10:17 AM		T 1: SETUP DATA WARNING					
Reconciliation Diagnostics - Status							Manual Clear
Status	Reconciliation						
Status Warning Reasons							
DIM Out Meter Map Not Complete							

This screen contains a list of causes for Reconciliation events.

#### Report Column Description

---

##### Reason

Each of the possible reasons is described below:

- DIM out/alarm/setup issues - Any dim alarms. All tanks will be set.
- DIM missing starts or stops - Set when a fake start or fake end event is generated. A fake start indicates we received an end event but no start event. A fake end indicates we have received a start event and no event. Normal trigger time is 15 minutes. All tanks will be set.
- DIM data from phantom meters - When an 'invalid meter' (end event and meter count = 0 or > 2) is received All tanks will be set.



## **TLS-450 Setup and Operation Screens Manual**

- Meter-map - not complete - Set when any dim events received and one of the tanks is not mapped. All tanks will be set.
- Meter-map - unstable/changes during period - Any time the meter map table is changed (reset, clear, unlock, lock, mapped). All tanks will be set.
- Invalid fuel height - When an 'Invalid Fuel Height' is triggered. Set per individual tank.
- Probe-out - When a 'Probe Out Alarm' is triggered. Set per individual tank.
- Water removed - Check at Daily /Shift close time. Set when the water height from the previous close is greater then the current water height. Set per individual tank.
- Power outage - Always get set on power up or system reset. All tanks will be set.
- Tank Chart Change (indicate what tank chart is used, and its quality level) [set per tank] - Check at Daily /Shift close time.  
Set when the time of the tank chart from the previous close is different from the current recorded time. Set per individual tank.
- DIM Queue Over Run - When we are receiving more Dim events then can be handled. All tanks will be set.

### **Control Buttons (on right side of screen)**

---

#### **Manual Clear**

Touching the 'Manual Clear' button causes the 'Confirm Manual Clear' dialog to display in which you can clear the events from the screen.

## Reconciliation Diagnostics - Reconciliation

03/08/2010 10:18 AM		M 1: DISABLED DIM ALARM							
Reconciliation Diagnostics - Reconciliation #1								Product 1 :	More
From 02/21/2010 10:17 AM TO 03/08/2010 10:17 AM									
Status	Reconciliation							BIR Report	
Date & Time	Metered Sales	Variance	Status Warning Reasons...						
Product 1 :									
								Select Range	
Product 1									

This screen contains every daily Reconciliation record, including total sales and variance for the day. If during the day an event occurred that could have affected the variance, the reasons column will show one or more possible causes.

1. Variances are calculated daily as follows:
  - Computed Daily end volume = Start volume - total sales + deliveries
  - Daily variance = Computed daily end volume - measured end volume
2. Daily sales and variances are totaled over the defined reconciliation period.
3. The total variance over the defined reconciliation period is compared to the Periodic Reconciliation Alarm Threshold (User programmed % of total metered sales + offset).
4. If the total variance over the defined reconciliation period exceeds the Periodic Reconciliation Alarm Threshold, the event is added to this report.

## **Report Column Descriptions**

---

### **Date & Time**

Time the reconciliation record was added.

### **Metered Sales**

The total metered sales over the defined reconciliation period.

### **Variance**

Total variance over the defined reconciliation period.

### **Reasons**

Possible messages:

- DIM out/alarm/setup issues - Any dim alarms. All tanks will be set.
- DIM missing starts or stops - Set when a fake start or fake end event is generated. A fake start indicates we received an end event but no start event. A fake end indicates we have received a start event and no event. Normal trigger time is 15 minutes. All tanks will be set.
- DIM data from phantom meters - When an 'invalid meter' (end event and meter count = 0 or > 2) is received All tanks will be set.
- Meter-map - not complete - Set when any dim events received and one of the tanks is not mapped. All tanks will be set.
- Meter-map - unstable/changes during period - Any time the meter map table is changed (reset, clear, unlock, lock, mapped). All tanks will be set.
- Invalid fuel height - When an 'Invalid Fuel Height' is triggered. Set per individual tank.
- Probe out - When a 'Probe Out Alarm' is triggered. Set per individual tank.
- Water removed - Check at Daily /Shift close time. Set when the water height from the previous close is greater then the current water height. Set per individual tank.
- Power outage - Always get set on power up or system reset. All tanks will be set.
- Tank Chart Change (indicate what tank chart is used, and its quality level) [set per tank] - Check at Daily /Shift close time.  
Set when the time of the tank chart from the previous close is different from the current recorded time. Set per individual tank.
- DIM Queue Overrun - When we are receiving more Dim events then can be handled. All tanks will be set.

## **Control Buttons (on right side of screen)**

---

### **More**

Touching the 'More' button will shift the report over (right or left) to reveal additional columns outside of the data view area.

### **BIR Report**

Touch this button to view the daily record Reconciliation Report for the selected product.

### **Select Range**

Touch this button to select whether to filter the contents of the report by a Date Range, by week, by month or a rolling period.

## Probe

### Probe Diagnostics - General

07/28/2008 02:32 PM		Pm 2: PUMP OUT							
Diagnostics - Probes - General #1								Probe 1	More
General		Reference Distance	Channel	MAG Options	Communication				
Type	Code	Length	Serial No.	Date (Yr/Wk)	Rev.....				
Probe 1: REGULAR - Tank 1									
MAG1	c000	96.00	176011		0				
Probe 1		Probe 2		Probe 3					

The Probe Diagnostics - General screen displays a report with general information about each probe.

#### Report Column Descriptions

##### Type

Probe Type Description (e.g., Mag 1)

##### Code

Circuit Code (Hex number)  
Value range: 0000-FFFF

##### Length

Probe Length  
Value range: 0.00 to 390.99 in. (0.00 to 9906.00mm)

**Serial No.**

Probe Serial Number  
Value range: 0 to 7 characters

**Date (Yr/Wk)**

Build Date by Year / Week  
Value range: YY/0 - 52

**Rev**

Revision Number  
Value range: 00 to 99

**Gradient**

Probe Gradient  
Value range: 0.000 to 999.999

**Probe Diagnostics - General Screen Refresh Rate**

---

The General Probe Diagnostics data will be refreshed every 30 seconds.

**Control Button (right of screen)**

---

**Probe Setup** 

Touch this button open the [Device Setup - Probes](#) screen.

## Probe Diagnostics - Reference Distance

2007/11/06 11:08 AM		T 1: DELIVERY NEEDED	?			
Diagnostics - Probes - Reference Distance						All Probes
General	Reference Distance	Channel	MAG Options	Communication		
Type	Serial No.	Original Date	Original Reference	Current Date	Current Reference	
Probe 1: - Tank 1						
MAG7	3555185547	2007/11/06	102.15	2007/11/06	102.15	
Probe 2: - Tank 2						
MAG7	3555185547	2007/11/06	102.15	2007/11/06	102.15	
Probe 3: - Tank 3						
MAG10	3555185550	2007/11/06	102.23	2007/11/06	102.23	
Probe 4: - Tank 4						
MAG1	3270820499	2007/11/06	43.70	2007/11/06	43.70	
All Probe	Probe 1	Probe 2	Probe 3	Probe 4		

The Probe Diagnostics - Reference Distance screen displays a report with Original and Current Reference distances for each probe.

### Report Column Descriptions

**Type**

Probe Type Description (e.g., Mag 1)

**Serial No.**

Probe Serial Number

Value range: 0 to 7 characters

**Original Date**

Original Reference Distance Reading Date

Value range: Year, month, and day

**Original Reference**

Original Reference Distance Reading

Value: 0.00 to 390.00 in. (0.00 to 9906.00mm)

**Current Date**

Current Reference Distance Reading Date

Value: Year, month, and day

**Current Reference**

Current Reference Distance Reading

Value: 0.00 to 390.00 in. (0.00 to 9906.00mm)

**Probe Diagnostics - Reference Distance Screen Refresh Rate**

---

The Probe Reference Distance data will be refreshed every 30 seconds.

**Control Buttons (right of screen)**

---

**Probe Setup** 

Touch this button open the [Device Setup - Probes](#) screen.



## Probe Diagnostics - Channel

07/28/2008  
02:32 PM

Cn 8: SETUP DATA WARNING

Diagnostics - Probes - Last Sample #1
Probe 1

General
Reference Distance
Channel
MAG Options
Communication

	0	1	2	3	4	5	6	7.....	
<b>Probe 1: REGULAR - Tank 1</b>									
00	49152.00	568.00	5830.00	5830.00	5830.00	5830.00	5830.00	5829.00	
10	5829.00	5829.00	40000.00	21993.00	21993.00	21993.00	21993.00	21993.00	
20	11.00	1200.00	40768.00	32770.00	63232.00	1.00	0.00	1.00	

Probe 1

Probe 2

Probe 3

The Probe Diagnostics - Channel screen displays a report with Channel data information for each probe.

### Report Description

Each probe's channel data is preceded by the following header information:

- Probe label (e.g., 1) and type (e.g., Mag 1)
- Probe serial number (up to 7 digits)
- Date and time (time channel data was received)
- Channel Data - Label for the Channel Section

Channel data (Hex number) is read from the report as shown in the example below:

Row	Col. 0	Col. 1	Col. 2	Col. 3	Col. 4	Col. 5	Col. 6	Col. 7	Col. 8	Col. 9
00	<b>B610</b>	05EB	29FC	<b>0235</b>	2C32	29FD	E240	0001	0008	C941
10	0001	61A7	0000	0000	0000	0000	<b>00A1</b>	80C4	0081	80C4

In the example above, the last sample for Channel 0 is **B610**, for Channel 3 it is **0235**, and for channel 16 it is **00A1**.

## **Probe Diagnostics Channel Refresh Rate**

---

The Probe Diagnostics Channel data will be refreshed every 5 seconds.

## **Control Button (right of screen)**

---

### **Probe Setup**

Touch this button open the [Device Setup - Probes](#) screen.

## Probe Diagnostics - Mag Options

07/28/2008 02:32 PM		Pm 2: PUMP OUT						
Diagnostics - Probes - MAG Options #1							Probe 1	More
General	Reference Distance	Channel	MAG Options	Communication				
Low Temperature	Water	Leak 0.1	Leak 0.2	Leak 3.0.....				
Probe 1: REGULAR - Tank 1								
NO	YES	YES	YES	YES				
Probe 1	Probe 2	Probe 3						

The Probe Diagnostics - Mag Options screen displays a report with options supported by Mag Probes.

### Report Column Descriptions

#### Low Temp

Indicates whether or not the probe supports the low temperature option.

Possible messages:

- Yes
- No

#### Water

Indicates whether or not the probe supports the water option.

Possible messages:

- Yes
- No

**Leak 0.1(0.38)**

Indicates whether or not the probe supports the leak 0.1 (gph [0.38 lph]) option.

Possible messages:

- Yes
- No

**Leak 0.2 (0.76)**

Indicates whether or not the probe supports the leak 0.2 (gph [0.76 lph]) option.

Possible messages:

- Yes
- No

**Leak 3.0 (11.3)**

Indicates whether or not the probe supports the leak 3.0 (gph [11.3 lph]) option.

Possible messages:

- Yes
- No

**Probe Diagnostics - Mag Options Screen Refresh Rate**

---

The Mag Options data will be refreshed every 30 seconds.

**Control Button (right of screen)**

---

**Probe Setup** 

Touch this button open the [Device Setup - Probes](#) screen.

## Probe Diagnostics - Communication

07/28/2008 02:33 PM		R 3: DEVICE OUT WARNING						
Diagnostics - Probes - Communication #1							Probe 1	More
General	Reference Distance	Channel	MAG Options	Communication				
Type	Status	Samples Read	Samples Used	Parity.....				
Probe 1: REGULAR - Tank 1 MAG1	OK	232	231	0				

The Probe Diagnostics - Communication screen displays a report with communication health and status parameters for each probe.

### Report Column Descriptions

#### Type

Probe type (e.g., Mag 1)

#### Status

Probe Status.

Possible messages:

- OK
- OUT

#### Samples Read

Number of samples read.

Value range: 0 to 4294967295

**Samples Used**

Number of samples used.

Value range: 0 to 4294967295

**Parity**

Number of parity errors.

Value range: 0 to 999999

**Partial**

Number of partial errors.

Value range: 0 to 999999

**Comm Errors**

Number of comm errors.

Value range: 0 to 999999

**Probe Diagnostics - Communication Refresh Rate**

---

The communication data will be refreshed every 5 seconds.

**Control Button (right of screen)**

---

**Probe Setup** 

Touch this button open the [Device Setup - Probes](#) screen.

## Relays & Inputs

### Relays and External Inputs Diagnostics - Relays

03/08/2010 10:06 AM				Pm 1: SETUP DATA WARNING							
Relays and External Inputs Diagnostics - Relays											
Relays		External Inputs									
	#	Address	Status	Duration	Type						Test Relays
<input checked="" type="checkbox"/>	R 1	B1.S1.5	Inactive	0000 00:45:29	Standard						Activate Relays
											Deactivate Relays
											Finish Test

The Relays and External Inputs Diagnostics - Relays screen lets you test all configured relays (except PLLD relays). Two types of relay tests are available:

1. Sequential Test: This test sets selected relays to INACTIVE for two seconds and then sets them to ACTIVE for two seconds. When the test is complete the relays are automatically reset to their original state.
2. Relay Inspection Test: This test sets selected relays to a selectable state, ACTIVE or INACTIVE, until the test is complete. When you finish the test the relays are automatically reset to their original state.

## **Column Descriptions**

---

### **Relay Selection Check boxes**

Check boxes are unchecked when the screen first opens. Relays can be individually selected / deselected by touching the check box by a specific relay. PLLD relays cannot be selected for these tests, so their check boxes will be grayed out in the relay list.

### **# (Relay identifier)**

Device code followed by 1 to 32 (e.g., R1)

### **Address**

Relay Device Address

Value: Console Number/Module slot/Module connection (e.g., B0.S5.2)

### **Status**

Relay State.

Possible messages: Active, Inactive

### **Duration**

Time the Relay has been in the current state.

### **Type**

The Relay type. Possible messages include:

- **STANDARD** - The On/Off state is determined by assigned alarms/warnings.
- **MOMENTARY** - The On/Off state is determined by assigned alarms/warnings. However, relay returns to the inactive state after the Alarm button is touched to acknowledge the alarm.

## **Control Buttons (right of screen)**

---

- **Setup** - touch to return to the Device Setup - Relays screen.
- **Test Relays** button - see Sequential Testing Procedure below.
- **Activate Relays, Deactivate Relays** and **Finish Test** buttons - see Inspection Testing Procedure below.

## **Sequential Testing Procedure**

---

To perform this test:

1. Select one or more relays. When the first relay is selected, the Test Relays button will become active (e.g. not grayed-out). After all the relays required for the test have been selected (checked), touch the Test Relays button to start the sequential test.



2. For each selected relay, the system will perform the following sequence:
  - **Save State:** The current relay state will be saved before a test is run on that specific relay.
  - **Highlight Relay:** For the relay being tested, the screen will highlight that relay during its test.
  - **Deactivate Relay:** The relay being tested will be put in an Inactive state for 2 seconds and the status of the relay on the screen will be set to Sw Test.
  - **Activate Relay:** The relay being tested will be put in an Active state for 2 seconds and the status of the relay on the screen will be set to Sw Test.
  - **Reset Relay:** Once the test completes, the relay will be returned to its original status which was saved at the beginning of the test. The status of the relay on the screen will be reset to its original status and it will no longer be highlighted. The test will continue with the next relay.
3. **Test Completion:** When the test has run through all the selected relays, the check boxes of the selected relays will remain selected. Touch the selected relays to deselect them or close the screen.

## **Inspection Testing Procedure**

---









1. **Select relays:** When the first relay is selected, the Activate Relays and Deactivate Relays buttons will become active (e.g. not grayed-out). Notice the Finish Test button is still grayed-out. The Test Relays button will be grayed-out (used for sequential testing only).
2. **Start the Test:** After all the relays required for the test have been selected (checked), touch either the Activate Relays or Deactivate Relays button to start the Relay Inspection test. The relays should be set to either Active or Inactive depending on the button pushed. Notice the Finish Test button is not grayed-out.
  - **Save State:** For each selected relay, its current state will be saved before the test is run on all selected relays.
  - **Highlight Relay:** All selected relays being tested will be highlighted on the screen during the test.
  - **Set Relays:** All the selected relays will be set to the Active or Inactive state depending on the button touched. The relays will remain in the selected state until the Finish Test button is touched. The status for each relay will be updated to indicate the test being performed (e.g. Active or Inactive).

**Finish Test:** To finish the test, touch the Finish Test button and the following occurs:

- **Reset Relay:** All selected relays will be returned their original state which was previously saved at the beginning of the test. The state of the relays on the screen should be set to their previous state as well.
- **Reset Screen:** All selected relays will be set to normal on the screen (e.g. highlight removed).

**Test Completion:** When the test completes, the selected relays will remain selected. Touch the selected relays to deselect them or close the screen.

## Relays and External Inputs Diagnostics - External Inputs

2007/11/06 04:24 PM			T 4: HIGH PRODUCT ALARM					
Relays and External Inputs Diagnostics - External Inputs								
Relays		External Inputs						
#	Address	Status	Duration	Type				
E1	B1.S3.2	Inactive	0028 18:14:06	Standard				
								
								

The Relays and External Inputs Diagnostics - External Inputs screen displays a report with diagnostic information about each external input.

### Report Column Descriptions

#### # (External input identifier)

External Input Identifier

Value: Device code followed by 1 to 32 (e.g., I1)

#### Address

External Input Device Address

Value: Box/slot/connection (e.g., B0.S5.2)

**Status**

External Input State

Possible messages: Active, Inactive

**Duration**

Time the External Input has been in the current state.

Value range: 0000 to 9999 days plus hh:mm:ss (e.g., 00001 03:05:48)

**Type**

The External Input type.

Possible messages:

- Standard
- Generator
- Pump Sense
- Standard ACK

**External Input Diagnostic Screen Refresh Rate**

---

The External Input data will be updated on change of state.

**Control Button (right of screen)**

---



Touch this button to open the "[Device Setup - External Inputs](#)" screen.

## Sensor

### Sensor Diagnostics - Liquid

2007/11/06 04:25 PM		T 4: HIGH PRODUCT ALARM				
Diagnostics - Sensors - Liquid						Sensor 1:
Liquid	Vapor	Groundwater	2-Wire CL	3-Wire CL		
Type	Category	Sample Counter	Value	Status		
Sensor 1:						
Tri-State(Single Float)	Other Sensors	0	0.000	Normal		

The Sensor Diagnostics - Liquid screen displays a report with information about each Liquid Sensor.

### Report Column Descriptions

#### Type

Sensor Type Description

Possible messages:

- Tri-State (Single Float)
- Normally Closed
- Dual Point Hydrostatic
- Dual Float Discriminating
- Dual Float High Vapor
- Interceptor Sensor

### **Category**

Sensor Category Description

Possible messages:

- Other Sensors
- Annular
- Dispenser Pan
- Monitoring Well
- STP Sump
- Containment Sump

### **Sample Counter**

Sensor Sample Counter value

Value range: 0 to 99

### **Value**

Resistance value

Value range: 0 to 1000000000

### **Status**

Sensor Status

Possible messages:

- Normal
- Unknown
- Setup Data Warning
- Fuel Alarm
- Out Alarm
- Short Alarm
- Water Alarm
- Water Out Alarm
- High Liquid Alarm
- Low Liquid Alarm
- Liquid Warning

## **Sensor Diagnostics Liquid Sensor Refresh Rate**

---

The Liquid Sensor Diagnostics data will be refreshed every 5 seconds.

### **Control Button (right of screen)**

---



Touch this button open the [Device Setup – Liquid Sensor](#) screen.

## Sensor Diagnostics - Vapor

2007/11/06 04:26 PM				T 2: SETUP DATA WARNING									
Diagnostics - Sensors - Vapor											Sensor 1:		
Liquid		Vapor		Groundwater		2-Wire CL		3-Wire CL					
Category		Sample Counter	Value 1	Value 2	Vapor Concentration	Status							
Sensor 1:													
Other Sensors		0	0.000	0.000	0	Normal							

The Sensor Diagnostics - Vapor screen displays a report with information about each Vapor Sensor.

### Report Column Descriptions

#### Category

Sensor Category Description

Possible messages:

- Other Sensors
- Annular
- Dispenser Pan
- Monitoring Well
- STP Sump
- Containment Sump

#### Sample Counter

Sensor Sample Counter value

Value range: 0 to 99

**Value 1**

Resistance value 1

Value range: 0 to 1000000000

**Value 2**

Resistance value 2

Value range: 0 to 1000000000

**Vapor Concentration**

The Vapor Concentration value in Parts Per Million

Value range: 0 to 999999999

**Status**

Sensor Status

Possible messages:

- Normal
- Unknown
- Setup Data Warning
- Fuel Alarm
- Out Alarm
- Short Alarm
- Water Alarm
- Water Out Alarm
- High Liquid Alarm
- Low Liquid Alarm
- Liquid Warning

**Sensor Diagnostics Vapor Sensor Refresh Rate**

---

The Vapor Sensor Diagnostics data will be refreshed every 5 seconds.

**Control Button (right of screen)**

---



Touch this button open the [Device Setup – Vapor Sensor](#) screen.

## Sensor Diagnostics - Groundwater

2007/11/06 04:26 PM		T 1: SUDDEN LOSS ALARM				
Diagnostics - Sensors - Groundwater						Sensor 1:
Liquid	Vapor	Groundwater	2-Wire CL	3-Wire CL		
Category	Sample Counter	Value 1	Value 2	Status		
Sensor 1: Other Sensors	0	0.000	0.000	Normal		

The Sensor Diagnostics - Groundwater screen displays a report with information about each Groundwater Sensor.

### Report Column Descriptions

#### Category

Sensor Category Description

Possible messages:

- Other Sensors
- Annular
- Dispenser Pan
- Monitoring Well
- STP Sump
- Containment Sump

#### Sample Counter

Sensor Sample Counter value

Value range: 0 to 99



**Value 1**

Resistance value 1

Value range: 0 to 1000000000

**Value 2**

Resistance value 2

Value range: 0 to 1000000000

**Status**

Sensor Status

Possible messages:

- Normal
- Unknown
- Setup Data Warning
- Fuel Alarm
- Out Alarm
- Short Alarm
- Water Alarm
- Water Out Alarm
- High Liquid Alarm
- Low Liquid Alarm
- Liquid Warning

---

**Sensor Diagnostics Groundwater Sensor Refresh Rate**

The Groundwater Sensor Diagnostics data will be refreshed every 5 seconds.

---

**Control Button (right of screen)**



Touch this button open the [Device Setup – Groundwater Sensor](#) screen

## Sensor Diagnostics - 2-Wire CL

2007/11/06 04:26 PM			T 2: SETUP DATA WARNING					
Diagnostics - Sensors - 2-Wire CL #1								Sensor 1:
Liquid	Vapor	Groundwater	2-Wire CL	3-Wire CL				
Type	Category	Sample Counter	Value	Status.....				
Sensor 1:								
Discrim. Interstitial	Other Sensors	0	0.000	Normal				

The Sensor Diagnostics 2-Wire CL screen displays a report with information about each Type A 2-Wire CL Sensor.

### Report Column Descriptions

#### Type

Sensor Type Description

Possible messages:

- ULTRA 2
- Discriminating Interstitial

#### Category

Sensor Category Description

Possible messages:

- Other Sensors
- Annular
- Dispenser Pan
- Monitoring Well
- STP Sump

- Containment Sump

**Sample Counter**

Sensor Sample Counter value

Value range: 0 to 99

**Value**

Resistance or current value

Value range: 0 to 1000000000 (Resistance Value) or 0.0 to 50.0 (Current Value in microamps)

**Status**

Sensor Status

Possible messages:

- Normal
- Unknown
- Setup Data Warning
- Fuel Alarm
- Out Alarm
- Short Alarm
- Water Alarm
- Water Out Alarm
- High Liquid Alarm
- Low Liquid Alarm
- Liquid Warning

**Sensor Diagnostics 2-Wire CL Sensor Refresh Rate**

---

The 2-Wire CL Sensor Diagnostics data will be refreshed every 5 seconds.

**Control Button (right of screen)**

---



Touch this button open the [Device Setup – Type A Sensor \(2-Wire CL\)](#) screen.

## Sensor Diagnostics - 3-Wire CL

2007/11/06 04:27 PM			T 3: SETUP DATA WARNING					
Diagnostics - Sensors - 3-Wire CL #1							Sensor 1:	More
Liquid	Vapor	Groundwater	2-Wire CL	3-Wire CL				
Type	Category	Sample Counter	Value 1	Value 2	Status.....			
Sensor 1: Ultra/Z-1                      Other Sensors                      0                      0.000                      0.000 Normal								

The Sensor Diagnostics 3-Wire CL screen displays a report with information about each Type B 3-Wire CL Sensor.

### Report Column Descriptions

#### Type

Sensor Type Description

Possible messages:

- Ultra/Z-1 (4Site Pan/Sump:Standard)
- Ultra/Z-1 HV (4Site Pan/Sump:Hi Vapor)

#### Category

Sensor Category Description

Possible messages:

- Other Sensors
- Annular
- Dispenser Pan

## TLS-450 Setup and Operation Screens Manual

- Monitoring Well
- STP Sump
- Containment Sump

### Sample Counter

Sensor Sample Counter value

Value range: 0 to 99

### Value 1

Resistance or current value

Value range: 0 to 1000000000 (Resistance Value) or 0.0 to 50.0 (Current Value in microamps)

### Value 2

Resistance value

Value range: 0 to 1000000000

### Status

Sensor Status

Possible messages:

- Normal
- Unknown
- Setup Data Warning
- Fuel Alarm
- Out Alarm
- Short Alarm
- Water Alarm
- Water Out Alarm
- High Liquid Alarm
- Low Liquid Alarm
- Liquid Warning

## Sensor Diagnostics 3-Wire CL Sensor Refresh Rate

---

The 3-Wire CL Sensor Diagnostics data will be refreshed every 5 seconds.

## Control Button (right of screen)

---



Touch this button open the [Device Setup – Type B Sensor \(3-Wire CL\)](#) screen.

## Mag Sensor

### Mag Sensor Diagnostics - General

12/07/2007 09:32 AM				T 1: OVERFILL ALARM									
Diagnostics - General											MAG		
General			Comm		Constants			Channel					
Type	Status	Serial Number	Date	Fuel Height	Water Height	Total Height							
059-MAG SENSOR	SENSOR NORMAL	0000000	00/00	0.00	0.00	0.00							
059-MAG SENSOR	SENSOR NORMAL	0000000	00/00	0.00	0.00	0.00							
059-MAG SENSOR	SENSOR NORMAL	0000000	00/00	0.00	0.00	0.00							
059-MAG SENSOR	SENSOR NORMAL	0000000	00/00	0.00	0.00	0.00							
059-MAG SENSOR	SENSOR NORMAL	0000000	00/00	0.00	0.00	0.00							
059-MAG SENSOR	SENSOR NORMAL	0000000	00/00	0.00	0.00	0.00							
059-MAG SENSOR	SENSOR NORMAL	0000000	00/00	0.00	0.00	0.00							
059-MAG SENSOR	SENSOR NORMAL	0000000	00/00	0.00	0.00	0.00							
059-MAG SENSOR	SENSOR NORMAL	0000000	00/00	0.00	0.00	0.00							
059-MAG SENSOR	SENSOR NORMAL	0000000	00/00	0.00	0.00	0.00							
059-MAG SENSOR	SENSOR NORMAL	0000000	00/00	0.00	0.00	0.00							
059-MAG SENSOR	SENSOR NORMAL	0000000	00/00	0.00	0.00	0.00							
059-MAG SENSOR	SENSOR NORMAL	0000000	00/00	0.00	0.00	0.00							
059-MAG SENSOR	SENSOR NORMAL	0000000	00/00	0.00	0.00	0.00							
059-MAG SENSOR	SENSOR NORMAL	0000000	00/00	0.00	0.00	0.00							
059-MAG SENSOR	SENSOR NORMAL	0000000	00/00	0.00	0.00	0.00							
059-MAG SENSOR	SENSOR NORMAL	0000000	00/00	0.00	0.00	0.00							
059-MAG SENSOR	SENSOR NORMAL	0000000	00/00	0.00	0.00	0.00							
059-MAG SENSOR	SENSOR NORMAL	0000000	00/00	0.00	0.00	0.00							
059-MAG SENSOR	SENSOR NORMAL	0000000	00/00	0.00	0.00	0.00							
059-MAG SENSOR	SENSOR NORMAL	0000000	00/00	0.00	0.00	0.00							

The Mag Sensor Diagnostics - General screen displays a report with general diagnostic information about all Mag Sensors.

#### Report Column Descriptions

##### Type

Sensor Type Description

Possible messages:

- 059-MAG Sensor

##### Status

Sensor Status. Multiple alarms will be shown in the same cell on separate lines.

Possible messages:

- Normal

## TLS-450 Setup and Operation Screens Manual

- Communication Alarm
- Fault Alarm
- Install Alarm

### **Serial Number**

Sensor Serial Number

Value: XXXXXXXX

### **Date**

Sensor Date Code

Value: Year/week (YY/WW)

### **Fuel Height**

Fuel Height detected by the Mag Sensor

Value range: 0.00 to 48.00 in. (0.00 to 1219.20mm)

### **Water Height**

Water Height detected by the Mag Sensor

Value range: 0.00 to 48.00 in. (0.00 to 1219.20mm)

### **Total Height**

Absolute liquid height as measured by the Mag Sensor

Value range: 0.00 to 48.00 in. (0.00 to 1219.20mm)

### **Fluid Temp**

Temperature of the fluid in which the Mag Sensor is submerged

Value range: -40.0 to 140.0°F (-40.0 to 60.0°C)

### **Brd Temp**

Temperature of the Mag Sensor's printed circuit board

Value range: -40.0 to 140.0°F (-40.0 to 60.0°C)

## **Mag Sensor Diagnostics - General Screen Refresh Rate**

---

The Mag Sensor Diagnostics - General data will be refreshed every 8 seconds.

### **Control Button (right of screen)**

---



Touch this button open the [Device Setup - Mag Sensor](#) screen.

## Mag Sensor Diagnostics - Comm

2007/11/06 11:03 AM		T 4: SETUP DATA WARNING				
Diagnostics - Comm						MAG
General	Comm	Constants	Channel			
Samples Read	Samples Used	Parity Errors	Partial Read	Comm Errors	Restarts	
MAG 1:	49	48	0	0	0	0

The Mag Sensor Diagnostics - Comm screen displays a report with communication diagnostic information about all Mag Sensors.

### Report Column Descriptions

#### Samples Read

Number of Samples Read

Value range: 0 to 4294967295

#### Samples Used

Number of Samples Used

Value range: 0 to 4294967295

#### Parity Errors

Number of Parity Errors

Value range: 0 to 999999



**Partial Read**

Number of Partial Errors

Value range: 0 to 999999

**Comm Errors**

Number of Comm Errors

Value range: 0 to 999999

**Restarts**

Number of Restarts

Value range: 0 to 999999

**Mag Sensor Diagnostics - Comm Screen Refresh Rate**

---

The Mag Sensor Diagnostics - Comm data will be refreshed every 8 seconds.

**Control Button (right of screen)**

---



Touch this button open the [Device Setup - Mag Sensor](#) screen.

## Mag Sensor Diagnostics - Constants

2007/11/06 11:04 AM		T 1: DELIVERY NEEDED						
Diagnostics - Constants						MAG		
General	Comm	Constants	Channel					
Serial Number	Model	Length	Gradient	Min Threshold	Max Threshold	Num Floats	Temp	Install Pos
MAG 1:								
0017945	112	24.00	395.420	1.7	22.0	2	Yes	Yes

The Mag Sensor Diagnostics - Constants screen displays a report with constants diagnostic information about all Mag Sensors.

### Report Column Descriptions

#### Serial Number

Mag Sensor Serial Number

Value: XXXXXXXX

#### Model

Mag Sensor Model Number

Value range: 0 to 65535

#### Length

Mag Sensor Length

Value range: 0.00 to 144.00 in. (0.00 to 3657.60mm)

**Gradient**

Mag Sensor Gradient - counts per inch (no conversion here)

Value range: 100.000 to 400.000

**Min. Threshold**

Mag Sensor Minimum Threshold

Value range: 0.1 to 144.0 in. (2.5 to 3657.6mm)

**Max. Threshold**

Mag Sensor Maximum Threshold

Value range: 0.1 to 144.0 in. (2.5 to 3657.6mm)

**Num. Floats**

Mag Sensor Number of Floats

Possible messages:

- 1
- 2

**Temp.**

Mag Sensor Temperature Enabled Flag

Possible messages:

- Yes
- No

**Install Pos.**

Mag Sensor Install Position Enabled Flag

Possible messages:

- Yes
- No

**Control Buttons (right of screen)**

---



Touch this button open the [Device Setup - Mag Sensor](#) screen.

## Mag Sensor Diagnostics - Channel

2007/11/06 11:05 AM				T 4: SETUP DATA WARNING						
Diagnostics - Channel										MAG
General		Comm	Constants		Channel					
#	0	1	2	3	4	5	6	7	8	9
MAG 1: '945 AM Data										
00	B610	05CD	297D	0235	2BB2	297D	4619	0000	0008	C862
10	0001	4025	B0BC	4372	41CE	B0B9	00A1	80C4	0081	80C4
20	83A4	83B2	0000	0000	7366	41E7	251C	0258	01F4	02BC
30	0228	2B2F	0898	00AA	0FFE	0070	0960	0004	0924	3FCC
40	CCCD	0F45	4000	0000	0346	40A0	0000	016D	4080	0000
50	81B9									

The Mag Sensor Diagnostics - Channel screen displays a report with channel diagnostic information about all Mag Sensors.

### Report Description

Each Mag Sensor's channel data is preceded by the following information:

- Mag Sensor number (e.g., 1) and label (e.g., Mag Sensor 1)
- Mag Sensor serial number (up to 7 digits)
- Date and time (time channel data was received)

Channel data (Hex number) is read from the report as shown in the example below:

Row	Col. 0	Col. 1	Col. 2	Col. 3	Col. 4	Col. 5	Col. 6	Col. 7	Col. 8	Col. 9
00	<b>B610</b>	05EB	29FC	<b>0235</b>	2C32	29FD	E240	0001	0008	C941
10	0001	61A7	0000	0000	0000	0000	<b>00A1</b>	80C4	0081	80C4

In the example above, the last sample for Channel 0 is **B610**, for Channel 3 it is **0235**, and for channel 16 it is **00A1**.

## **Mag Sensor Diagnostics - Channel Screen Refresh Rate**

---

The Mag Sensor Diagnostics - Channel data will be refreshed every 8 seconds.

### **Control Buttons (right of screen)**

---



Touch this button open the [Device Setup - Mag Sensor](#) screen.

## Line Pressure Sensor

### LPR Sensor Diagnostics - General

2007/11/06 04:28 PM		T 1: SUDDEN LOSS ALARM					
LPR Sensor Diagnostics - Communications						LPSensr	More
General	Comm	Constants	Channel				
Samples Read	Samples Used	Parity Errors	Partial Read	Comm Errors	Restarts		
LPSensr 1:	0	0	0	0	0	0	
LPSensr 2:	0	0	0	0	0	0	
LPSensr 3:	0	0	0	0	0	0	
LPSensr 4:	0	0	0	0	0	0	
LPSensr 5:	0	0	0	0	0	0	
LPSensr 6:	0	0	0	0	0	0	
LPSensr 7:	0	0	0	0	0	0	
LPSensr 8:	0	0	0	0	0	0	
	0	0	0	0	0	0	

The LPR Sensor Diagnostics - General screen displays a report with general diagnostic information about all Line Pressure Sensors in the system. This screen is reached by selecting the Line Pressure Sensor icon in the diagnostic main screen.

#### Report Column Descriptions

##### Type

Sensor Type

Value: 063 -Line P Sensor

##### Status

Sensor Status

Possible messages:

- Normal
- Inactive

**Serial Number**

Sensor Serial Number

Value: XXXXXXXXXXX

**Date**

Build Date by Year / Week

Value: Year/week (YY/WW)

**Pressure**

Pressure detected by the Line Pressure Sensor

Value range: -14.000 to 99.999 psi (-96.485 to 689.173kPa)

**Diagnostics - LPR Sensor - General screen refresh rate**

---

The LPR Sensor Diagnostics - General data will be refreshed every second.

**Control Buttons (right of screen)**

---

**More**

Touching the 'More' button will shift the report over (right or left) to reveal additional columns outside of the data view area.

**Setup** 

Touch this button open the [Device Setup - Line Pressure Sensor](#) screen.

**PLLD Diagnostic** 

Touch this button to open the PLLD [Diagnostics – PLLD Status](#) screen.

## LPR Sensor Diagnostics - Communications

2007/11/06 04:28 PM		T 1: SUDDEN LOSS ALARM					
LPR Sensor Diagnostics - Communications						LPSensr	More
General	Comm	Constants	Channel				
Samples Read	Samples Used	Parity Errors	Partial Read	Comm Errors	Restarts		
LPSensr 1:	0	0	0	0	0	0	 
LPSensr 2:	0	0	0	0	0	0	
LPSensr 3:	0	0	0	0	0	0	
LPSensr 4:	0	0	0	0	0	0	
LPSensr 5:	0	0	0	0	0	0	
LPSensr 6:	0	0	0	0	0	0	
LPSensr 7:	0	0	0	0	0	0	
LPSensr 8:	0	0	0	0	0	0	

The LPR Sensor Diagnostics - Communication screen displays a report with communication diagnostic information for all Line Pressure Sensors.

### Report Column Descriptions

#### Samples Read

Number of Samples Read

Value range: 0 to 4294967295

#### Samples Used

Number of Samples Used

Value range: 0 to 4294967295

#### Parity Errors

Number of Parity Errors

Value range: 0 to 999999



**Partial Read**

Number of Partial Errors

Value range: 0 to 999999

**Comm Errors**

Number of Comm Errors

Value range: 0 to 999999

**Restarts**

Number of Restarts

Value range: 0 to 999999

**Diagnostics - LPR Sensor - Comm screen refresh rate**

---

The LPR Sensor Diagnostics - Communication data will be refreshed every 8 seconds.

**Control Buttons (right of screen)**

---

**More**

Touching the 'More' button will shift the report over (right or left) to reveal additional columns outside of the data view area.

**Setup** 

Touch this button open the [Device Setup - Line Pressure Sensor](#) screen.

**PLLD Diagnostic** 

Touch this button to open the PLLD [Diagnostics – PLLD Status](#) screen.

## LPR Sensor Diagnostics - Constants

2007/11/06 04:29 PM		T 1: DELIVERY NEEDED					
LPR Sensor Diagnostics - Constants						LPSensr	
General	Comm	Constants	Channel				More
Serial Number	Model	Firmware Version	Slope	Offset			
LPSensr 1:	1179467423	1	1	500.0	10000.0		
LPSensr 2:	1179532959	1	1	500.0	10000.0		
LPSensr 3:	1179598495	1	1	500.0	10000.0		
LPSensr 4:	1179664031	1	1	500.0	10000.0		
LPSensr 5:	557909571	1	1	500.0	10000.0		
LPSensr 6:	557975107	1	1	500.0	10000.0		
LPSensr 7:	558040643	1	1	500.0	10000.0		
LPSensr 8:	558106179	1	1	500.0	10000.0		

The LPR Sensor Diagnostics - Constants screen displays a report with constants diagnostic information about all Line Pressure Sensors in the system.

### Report Column Descriptions

**Serial Number**

Line Pressure Sensor Serial Number

Value: XXXXXXXXXXXX

**Model**

Line Pressure Sensor Model Number

Value range: 0 to 65535

**Firmware Version**

Line Pressure Sensor Software Version

Value range: 0 to 99

**Slope**

Line Pressure Sensor Slope

Value range: 0 to 65535

**Offset**

Line Pressure Sensor Offset

Value range: 0 to 65535

**Control Buttons (right of screen)**

---

**More**

Touching the 'More' button will shift the report over (right or left) to reveal additional columns outside of the data view area.









**Setup** 

Touch this button open the [Device Setup - Line Pressure Sensor](#) screen.

**PLLD Diagnostic** 

Touch this button to open the PLLD [Diagnostics – PLLD Status](#) screen.

## LPR Sensor Diagnostics - Channel

2007/11/06 04:29 PM		T 1: SETUP DATA WARNING									
LPR Sensor Diagnostics - Channel						LPSensr	<b>More</b>				
General	Comm	Constants	Channel								
#	0	1	2	3	4	5	6	7	8	9	
LPSensr 1:											
LPSensr 2:											
LPSensr 3:											
LPSensr 4:											
LPSensr 5:											
LPSensr 6:											
LPSensr 7:											
LPSensr 8:											

The LPR Sensor Diagnostics - Channel screen displays a report with channel diagnostic information about all Line Pressure Sensors.

### Report Description

---

Each Line Pressure Sensor's channel data is preceded by the following information:

**Sensor number:Label (e.g., Sensor 1:your label)**

**Serial number (XXXXXXXXXX)**

**Date and time (time channel data was received)**

Channel data is read from the report as shown in the example below:

Row	Col. 0	Col. 1	Col. 2	Col. 3	Col. 4	Col. 5	Col. 6	Col. 7	Col. 8	Col. 9
00	<b>B610</b>	05EB	29FC	<b>0235</b>	2C32	29FD	E240	0001	0008	C941
10	0001	61A7	0000	0000	0000	0000	<b>00A1</b>	80C4	0081	80C4

In the example above, the last sample for Channel 0 is **B610**, for Channel 3 it is **0235**, and for channel 16 it is **00A1**.

Data Type: Hexidecimal  
Value range: 0000 to FFFF

**Diagnostics - Line Pressure Sensor - Channel screen refresh rate**

---

The Line Pressure Sensor Diagnostics - Channel data will be refreshed every 8 seconds.

**Control Buttons (right of screen)**

---

**More**

Touching the 'More' button will shift the report over (right or left) to reveal additional columns outside of the data view area.

**Setup** 

Touch this button open the [Device Setup - Line Pressure Sensor](#) screen.

**PLLD Diagnostic** 

Touch this button to open the PLLD [Diagnostics – PLLD Status](#) screen.

## AccuChart II

### AccuChart II Diagnostics - Delivery Instructions

03/08/2010 04:04 PM		All Functions Normal					
AccuChart II Diagnostics - Delivery Instructions							
Delivery Instructions		Time Ordered Comparison		Histogram Comparison			
Tank		Date		Delivery Instructions			
1		03/08/2010		Schedule a delivery to fill your tank to 10000.0 GALLONS			

This screen contains instructions to help you achieve calibration data over the range of the tank. Only tanks that are actively running AccuChart II and have actionable messages will appear in this report. Messages will be generated by AccuChart II and added to this list. AccuChart II will also decide when existing messages should be changed or removed.

#### Report Column Descriptions

---

##### **Tank**

Selected tank label.

##### **Date**

Date message posted.

##### **Delivery Instructions**

Possible messages include:

1. No Message.
2. Schedule a delivery to fill your tank to xx level.
3. Postpone delivery until tank level recedes to yy level.

## AccuChart II Diagnostics - Time Ordered Comparison

03/08/2010 03:59 PM		All Functions Normal	?		7			
AccuChart II Diagnostics - Time Ordered Sales Comparison							Tank 1 : Regular	Comp.
Time Ordered Comparison		Histogram Comparison		Error Plot Comparison		◀ ▶		Show Var%
Open Date	Sales Volume	initial user chart Variance	Last AccuChart Variance					Show Deliv
10/14/2009	1157.5	-41.3	-0.4					Select Range
10/13/2009	483.3	-15.4	0.4					
10/12/2009	1155.3	-29.5	-0.6					
10/11/2009	2223.0	33.4	0.1					
10/10/2009	369.0	37.8	-0.5					
10/09/2009	1919.4	12.4	-0.8					
10/08/2009	2151.1	-62.9	0.2					
10/07/2009	1928.7	-64.2	-0.3					
10/06/2009	1481.7	-24.0	-1.0					
10/05/2009	1809.8	78.8	-0.2					
10/04/2009	1724.1	0.6	-0.4					
10/03/2009	1645.4	-46.7	0.1					
10/02/2009	217.7	-8.6	-1.0					
10/01/2009	695.9	-24.6	0.1					
09/30/2009	58.7	-1.1	0.9					
09/29/2009	2517.8	-65.9	-0.4					
09/28/2009	1782.3	40.0	0.6					
09/27/2009	283.9	26.7	0.3					
							◀ ▶	▲ ▼

This report lists all tank calibrating records applied to two selectable tank charts, over a selectable range, with variances displayed for each chart in adjoining columns. You can display the Variances as volumes or as percentage of sales volumes. A separate button gives you a report of Delivery variances made using both charts within the selected calibration period.

### Report Column Descriptions

#### Open Date & Time

Start time of tank calibration record.

#### Sales Volume

Total sales reported by the POS terminal during the tank calibration record.

#### 'Chart Name 1' Variance

Variance for the record as determined using 'Chart Name 1' calibration data.

#### Chart Name 2 Variance



Variance for the record as determined using 'Chart Name 2' calibration data.

## **Control Buttons (Right side of screen)**

---

### **Comp.**

Touching the 'Compare' button will show the 'Select Charts to Compare' dialog. You select the tank charts to compare from the drop down list beside each field.

Touch the  button to accept the selections or  button to abort and close the **Charts to Compare** dialog box.

### **Show Var %**

Touching the 'Show Var%' button will change the variance column heads from 'Variance' to 'Variance %' and the data from volume entries to percentage of sales volume entries.

### **Show Var.**

Touching the 'Show Var' button will change the variance column heads from 'Variance%' to 'Variance ' and the data from percentage of sales volume entries to volume entries.

### **Show Deliv**

Touching the 'Show Deliv(ery)' button will only be visible if Ticketed Deliveries are enabled, otherwise it will be hidden. Touching the 'Show Deliv' button; changes its label to 'Show Sales', puts 'Time Ordered Delivery Comparison' in the title bar and displays the following columns:

- End of Delivery Date & Time
- Chart label / Delivery Variance
- Chart label / Delivery Variance

Delivery variance is calculated as follows:

Delivery Variance = Ticketed Delivery volume - measured delivery volume corrected for sales during the delivery.

The delivery variance report lets you compare, side by side, the variances in deliveries as determined from the two charts you select.

### **Show Sales**

Touching the 'Show Sales' button; changes its label to 'Show Deliv', puts 'Time Ordered Sales Comparison' in the title bar and displays the following columns:

- Open Delivery Date & Time
- Sales Volume
- Chart label / Variance
- Chart label / Variance

### **More**

The More button will only be shown if Ticketed Deliveries are enabled. Otherwise it will be hidden. Touching the 'More' button will show the extra columns when deliveries are shown.

### **Select Range**

Pressing the 'Select Range' button will bring up the standard Select Range dialog. This range will be used to limit the data shown in the report. By default, it will be the last 30 days of reconciliation records.



## AccuChart II Diagnostics - Histogram Comparison

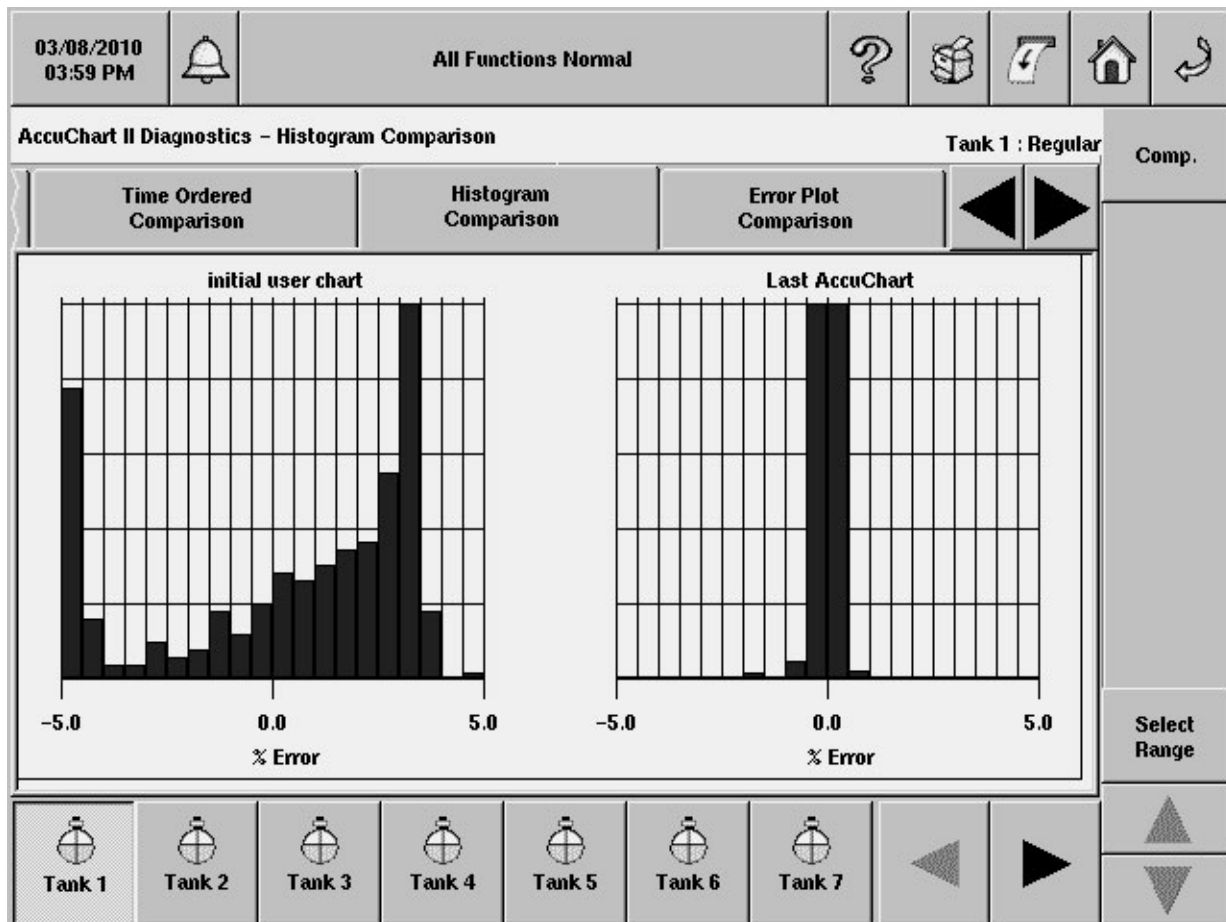



This screen lets you view a histogram comparison of two charts using the same data from one tank. The plots depict the accuracy of each of the charts over the tank's operating range - empty to full. The ideal goal of the calibration is to have one bar on the zero line across the full range of the tank (no error).

### Control Buttons (Right side of screen)

#### Comp.

Touching the 'Compare' button will show the 'Select Charts to Compare' dialog. You select the tank charts to compare from the drop down list beside each field.

Touch the  button to accept the selections or  button to abort and close the **Charts to Compare** dialog box.

#### Select Range

Pressing the 'Select Range' button will bring up the standard Select Range dialog. This range will be used to limit the data shown in the report. By default, it will be the last 30 days of reconciliation records.

## AccuChart II Diagnostics - Error Plot Comparison

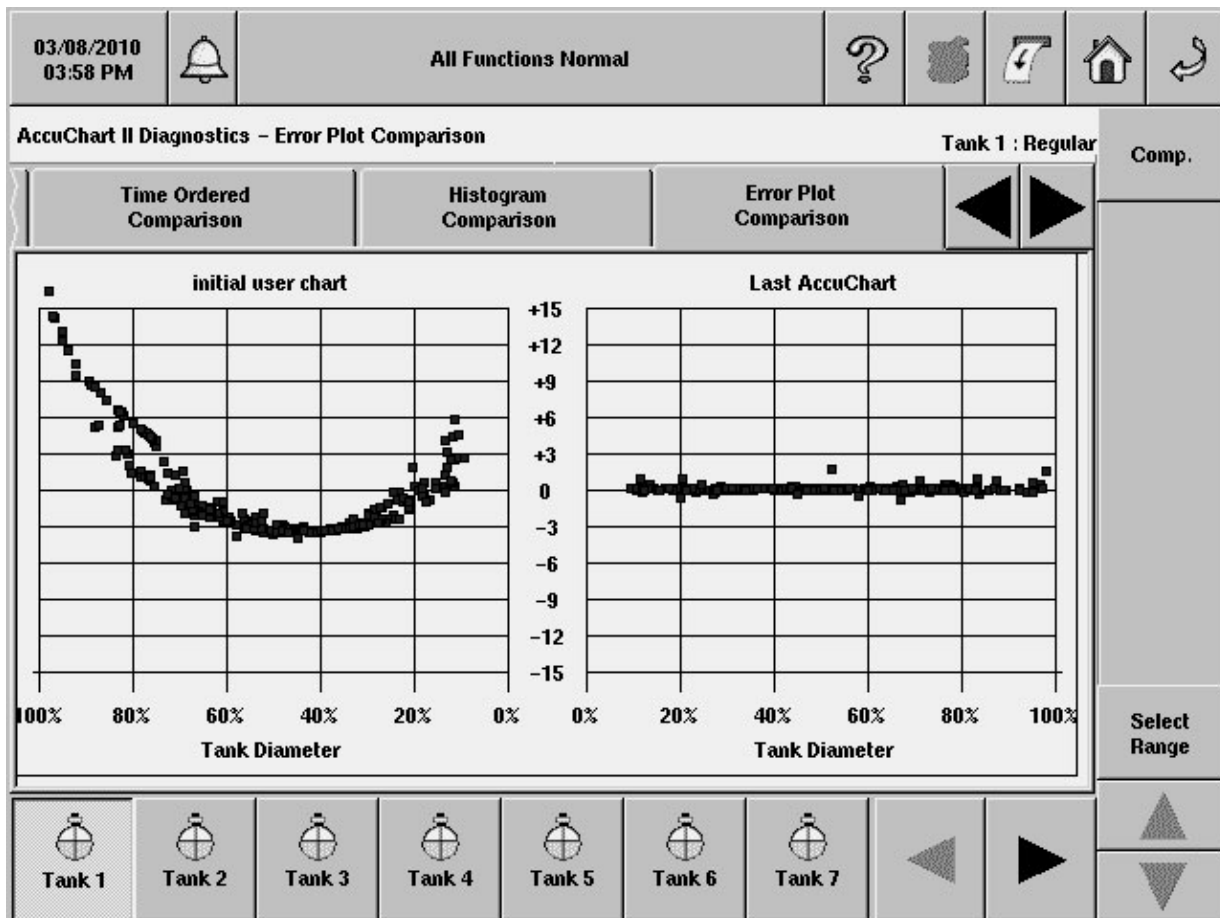



This screen lets you view an error plot comparison of two charts using the same data from one tank. The plots depict the accuracy of each of the charts over the tank's operating range - empty to full. The ideal goal of the calibration is to have all points on the zero line across the full range of the tank (no error).

### Control Buttons (Right side of screen)

#### Comp.

Touching the 'Compare' button will show the Select Charts to Compare dialog. You select the tank charts to compare from the drop down list beside each field.

Touch the  button to accept the selections or  button to abort and close the **Charts to Compare** dialog box.

#### Select Range

Pressing the 'Select Range' button will bring up the standard Select Range dialog. This range will be used to limit the data shown in the report. By default, it will be the last 30 days of reconciliation records.

## AccuChart II Diagnostics - Calibration Feedback

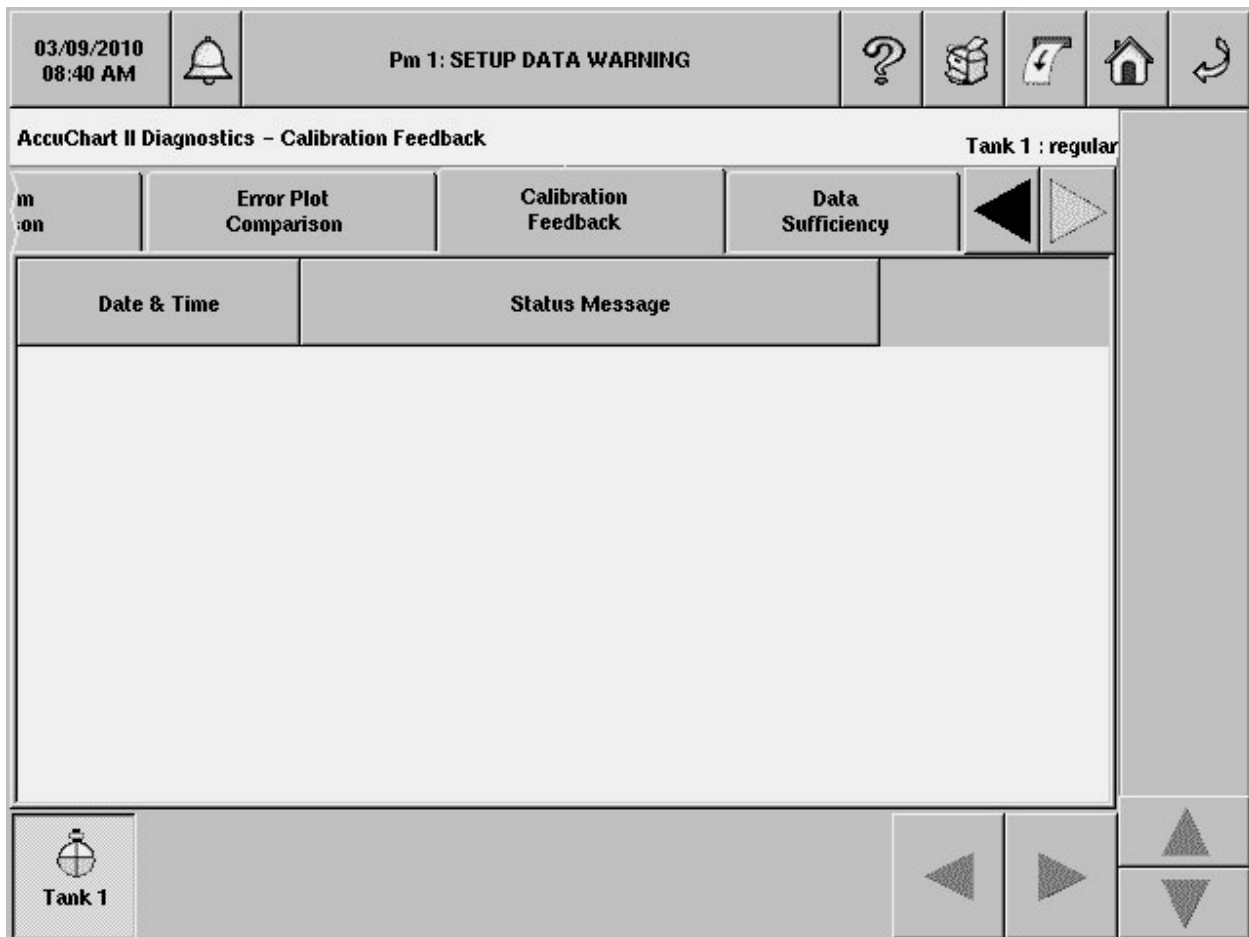

This screen contains alarms and warnings that are only issued for Automatic AccuChart II, not Manual Chart, or Remote Chart. Restarting calibration or the completion of calibration will clear these alarms, except where noted.

To minimize the risk of false/premature alarms, no warnings will be posted until Automatic AccuChart II has been running for at least 48 hours.

In addition to appearing in the AccuChart II Diagnostics - Calibration Feedback Warning Report, the warnings described below will also be displayed in the Alarm Status button and the Alarm Reports.

### Report Column Descriptions

#### Date & Time

Date and time alarm was posted.

## **Status Message**

Possible messages include:

- **Insufficient data collection rate** - Warning will be posted when the average number of records generated per day is less than N, and the throughput is below a threshold T.
- **Noisy data** - Warning will be posted after a calibration is generated, and the RMS Error of the data exceeds a threshold T.
- **Data too regionally concentrated** - Warning will be posted after N records are generated over time T, and the data sufficiency is less than the current threshold.
- **Initial tank parameters suspicious** - Warning will be posted after a calibration is generated, and the search algorithm hits a boundary.
- **Station too busy** - Warning will be posted when the average number of records generated per day is less than N, and the throughput is above a threshold T.
- **No Successful Calibration Has Happened** - Warning will be posted after a calibration should have been generated, but the algorithm was unable to generate a calibration. When you try to clear the warning, you will be prompted to extend, terminate, or restart the calibration period. Selecting any of these options will clear this warning.
- **Calibration done, quality validation required** - Warning will be posted after a calibration is generated, but the quality of the calibration is low. When you try to clear the warning, you will be prompted to extend, terminate, or restart the calibration period. Selecting any of these options will clear this warning.

## AccuChart II Diagnostics - Data Sufficiency

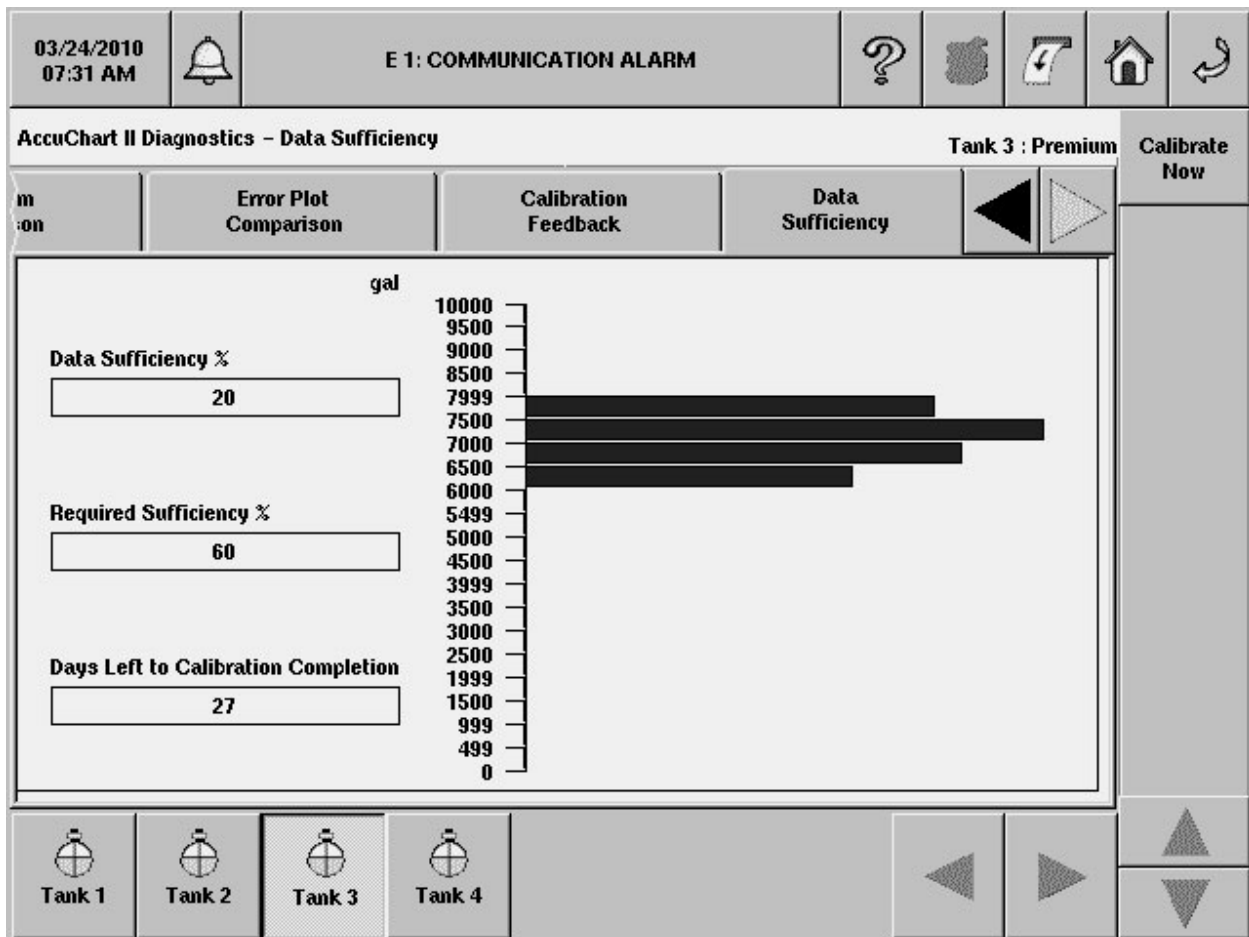

This screen lets you view a histogram of the data collected for the tank's calibration. The data in the chart will be for the current calibration if one is in progress, or for the last completed. The bars depict the concentration of data collected at different levels of the tank. Ideally you would want collected data (bars) across all levels of the tank.

When the chart calibration is applied to the tank depends on your 'Update Schedule' field's entry in the [Tank Setup - AccuChart II](#) screen.

Only tanks that are actively running AccuChart II will have tank buttons on the bottom of the screen.

### Data Sufficiency %

This read-only field contains the current percentage of collected calibration data. This percentage is updated as the data sufficiency approaches the Required Sufficiency % target. This field is updated at midnight of each day, or after you initiate a [Calibrate Now procedure](#).

### Required Sufficiency %

This read-only field contains the amount of data required to perform a calibration. Once the Data Sufficiency % achieves the Required Sufficiency % target and the calibration has been performed, the Required Sufficiency % is raised to a higher level. For example, from 60% to 70%. The tank calibration

will restart and continue until the Data Sufficiency % achieves the upgraded Required Sufficiency % value. This field is updated at midnight of each day, or after you initiate a [Calibrate Now procedure](#).

### **Days Left to Calibration Completion**

This read-only field contains the days left in the chart calibration process. The number of days to calibrate was selected in the Calibration Period field in the [Tank Setup - AccuChart II](#) screen.

### **Sufficiency Improvement Action**

The 'Sufficiency Improvement Action' field will only appear after one or more of the following warnings have been posted:

- Data Too Regionally Concentrated - Schedule more deliveries if insufficient data in top half of tank. Schedule fewer deliveries if insufficient data in bottom half of tank.
- Station Too Busy - Temporarily halt dispensing to introduce more idle periods.

The list of possible action messages in the 'Sufficiency Improvement Action' field includes:

- Stop Dispensing
- Start Dispensing
- Schedule Delivery Now
- Postpone Delivery

## **Control Buttons (Right side of screen)**

---

### **Calibrate Now**

Touching the 'Calibrate Now' button will let you force a calibration regardless of the current data sufficiency percentage. The name of the calibration will be 'Last AccuChart'. Pressing 'Calibrate Now' will bring up the 'Confirm Calibrating Now' dialog.

If a calibration is running on the selected tank, the 'Calibrate Now' button will display 'Calibrating'. If AccuChart II is not collecting data on the selected tank, the 'Calibrate Now' button will be disabled. If a calibration is running on an unselected tank, the 'Calibrate Now' button will be disabled.

Results of the Calibrate Now procedure will update the 'Data Sufficiency %' and 'Required Sufficiency %' fields.

## Modules

### Module Diagnostics - Hardware Configuration

12/07/2009 12:24 PM		L 3: SENSOR OUT ALARM		?		?		?		?	
Module Diagnostics - Hardware Configuration #1											More
Hardware Configuration			Device Directory		Device Assignments		Comm				
Address	Module Type	Board Part Number	Serial Number	HW Build Date	Fir R...						
B1.S1	USC - 16	332812-001	0000656641	12/05/2006	1-A'						
B1.S2	USC - 16	332812-001	0000656642	12/05/2006	1-A'						
B1.S3	USC - 16	332812-001	0000656643	12/05/2006	1-A'						
B1.S4	I/O - 8	332813-001	0000656804	12/05/2006	1-A'						
B1.S5	I/O - 4	332813-001	0000656805	12/05/2006	1-A'						
B8.S5	I/O - 1	332813-001	4278190081								
Slot 1	Dual RS-232	123456789ABCDEF	07121234	12/12/2007							
Slot 2	Fax Modem-alt	123456789ABCDEF	07121234	12/12/2007							
Slot 5	USB Ethernet	0332913-001	09140197	04/05/2009							

This screen lists console's module locations and hardware/software details.

#### Report Column Descriptions

##### Address

This column contains the physical address of the module, B1.S4 = Master 450/slot 4 [module bay - behind right door], Slot 1 = Comm slot 1 [comm bay - behind left door].

##### Module Type

This column contains the module type, e.g., USM-8 (Universal Sensor Module with 8 Inputs).

##### Board Part Number

This column contains the module's part number.

**Serial Number**

This column contains the module's serial number.

**HW Build Date**

This column contains the date the console was factory programmed.

**Firmware Revision**

This column contains the revision level of the console's firmware. This column will be blank for all Comm Cards.

**SW Build Date**

This column contains the date the console's software was compiled. This column will be blank for all Comm Cards except CDIMs.



## Module Diagnostics - Device Directory

12/07/2009 12:24 PM		C 2: SENSOR OUT ALARM		?		📦		📄		🏠		↶	
Module Diagnostics - Device Directory													
Hardware Configuration			Device Directory			Device Assignments			Comm				
Address		Type		Serial Number		Date Code		State					
B1.S1		UNIVERSAL SENS MODULE - 16		0000656641				In Service					
B1.S1.1		MAG PROBE		0000176011		0/00		In Service					
B1.S1.2		MAG PROBE		0000176012		0/00		In Service					
B1.S1.3		MAG PROBE		0000176013		0/00		In Service					
B1.S1.4		MAG PROBE		0000176014		0/00		In Service					
B1.S1.5		MAG PROBE		0000176015		0/00		In Service					
B1.S1.6		MAG PROBE		0000176016		0/00		In Service					
B1.S1.7		LINE P SENSOR		0547817027		0/00		In Service					
B1.S1.8		LINE P SENSOR		0547882563		0/00		In Service					
B1.S1.9		LINE P SENSOR		0547948099		0/00		In Service					
B1.S1.10		LINE P SENSOR		1179270815		0/00		In Service					
B1.S1.11		LINE P SENSOR		1179336351		0/00		In Service					
B1.S1.12		LINE P SENSOR		1179401887		0/00		In Service					
B1.S1.13		LEGACY RESISTIVE		0000165536		0/00		In Service					
B1.S1.14		LEGACY RESISTIVE		0000165536		0/00		In Service					
B1.S1.15		LEGACY RESISTIVE		0000165536		0/00		In Service					
B1.S1.16		LEGACY RESISTIVE		0000165536		0/00		In Service					
B1.S2		UNIVERSAL SENS MODULE - 16		0000656642				In Service					
B1.S2.1		LEGACY CURRENT		0000165536		0/00		In Service					
B1.S2.2		LEGACY CURRENT		0000165536		0/00		In Service					
B1.S2.3		LEGACY CURRENT		0000165536		0/00		In Service					
B1.S2.4		LEGACY CURRENT		0000165536		0/00		In Service					
B1.S2.5		LEGACY RESISTIVE		0000165536		0/00		In Service					

This screen lists the console's installed modules and their connected devices.

### Report Column Descriptions

#### Address

This column contains the physical address of the device, e.g., B1.S1 = Universal Sensor Module, B1.S1.4 = device connected to terminal 4 of the USM in slot 1).

#### Type

This column contains the device type, e.g., Universal Sensor Module, Mag Probe, etc.

#### Serial Number

This column contains the device's serial number.

#### Date Code

This column contains the factory build date (WW/YY) - product revision level.

#### State

This column contains the current status of the device. Possible messages: In Service or Out of Service

## Module Diagnostics - Device Assignments

12/07/2009 12:24 PM		Q 5: SETUP DATA WARNING		?		📦		🔍		🏠		↶	
Module Diagnostics - Device Assignments													
Hardware Configuration				Device Directory				Device Assignments				Comm	
M/Er	Bus Address	Type	Primary Assignment				Secondary Assignment						
M	B1.S1	USC - 16											
	B1.S1.1	Probe	Pb 1:				T 1: PRODUCT 1						
	B1.S1.2	Probe	Pb 2:				T 2: PRODUCT 2						
	B1.S1.3	Probe	Pb 3:				T 3: PRODUCT 3						
	B1.S1.4	Probe	Pb 4:				T 4: PRODUCT 4						
	B1.S1.5	Probe	Pb 5:				T 5: PRODUCT 5						
	B1.S1.6	Probe	Pb 6:				T 6: PRODUCT 6						
	B1.S1.7	LPSensr	PI 1:				Ln 1: PRESSURE LLD #1						
	B1.S1.8	LPSensr	PI 2:				Ln 2: PRESSURE LLD #2						
	B1.S1.9	LPSensr	PI 3:				Ln 3: PRESSURE LLD #3						
	B1.S1.10	LPSensr	PI 4:				Ln 4: PRESSURE LLD #4						
	B1.S1.11	LPSensr	PI 5:				Ln 5: PRESSURE LLD #5						
	B1.S1.12	LPSensr	PI 6:				Ln 6: PRESSURE LLD #6						
	B1.S1.13	ResSens	L 1: Liquid Sensor 1										
	B1.S1.14	ResSens	L 2: Liquid Sensor 2										
	B1.S1.15	ResSens	L 3: Liquid Sensor 3										
B1.S1.16	ResSens	L 4: Liquid Sensor 4											
M	B1.S2	USC - 16											
	B1.S2.1	CurSens	C 1: Type A 1										
	B1.S2.2	CurSens	C 2: Type A 2										
	B1.S2.3	CurSens	C 3: Type A 3										
	B1.S2.4	CurSens	C 4: Type A 4										
	B1.S2.5	ResSens	G 1: GW Sensor 1										

This screen contains modules, their connected devices and the device's primary and secondary assignments.

### Report Column Descriptions

#### M/Err

This column would be blank if everything is OK. If the device is a module, an 'M' will show up first. If there is an error it will be indicated by '!' followed by a reason code. If possible, other fields will be flagged with the '!' identifier to help point to the source of the problem. Possible errors are as follows:

- !1 missing primary assignment (if secondary missing two only !1 is displayed)
- !2 missing secondary assignment
- !3 Incorrect device assignment - device type changed

**Bus Address**

This column contains the bus address of the device, e.g., B1.S1.4 (Master 450, Slot 1, terminal 4).

**Type**

This column contains the device label, e.g., Probe

NOTES:

1. If a module slot inside the console is not populated (or recognized by the system) type will be 'None'.
2. If a device position on a module is not populated (or recognized by the system) type will be 'None'.

**Primary Assignment**

This column contains the device's primary assignment, e.g., P4. An error mark '!' is shown in case of a problem.

**Secondary Assignment**

This column contains the device's secondary assignment, e.g., T4:Product 4. An error mark '!' is shown in case of a problem.

## Module Diagnostics - Comm

12/07/2009 12:25 PM		Q 2: SETUP DATA WARNING			?		📦		🔍		🏠		↶		
Module Diagnostics - Comm #1													More		
Hardware Configuration			Device Directory			Device Assignments			Comm					Show Details	
Comm Number	Slot	Comm Type	Bytes Received	Bytes Transmitted	Parity Errors	Overrun Errors	Framing Errors	Break Interrupts							
Co 1	S1 - P1	RS232 CARD	0	0	0	0	0	0							
Co 2	S1 - P2	RS232 CARD	0	0	0	0	0	0							
Co 4	S2 - P2	INTERNAL MODEM	0	0	0	0	0	0							
													Reset Counters		
													▲		
													▼		

This screen contains a report of data transmission and reception results for installed communication modules.

### Report Column Descriptions

#### Comm Number

This column contains the comm card number, e.g., Co 1.

#### Slot

This column contains the comm bay slot and module port of the installed comm card, e.g., S1-P2 (Slot 1, Port 2).

#### Comm Type

This column contains the comm card type, e.g., RS232 card.

#### Bytes Received

This column contains the number of bytes received since the counter was reset.

**Bytes Transmitted**

This column contains the number of bytes transmitted since the counter was reset.

**Parity Errors**

This column contains the number of parity errors since the counter was reset.

**Overrun Errors**

This column contains the number of overrun errors since the counter was reset.

**Framing Errors**

This column contains the number of framing errors since the counter was reset.

**Break Interrupts**

This column contains the number of break interrupts since the counter was reset.

**Counter Reset Date and Time**

This column contains the date and time you last reset this card's counters.

**Control Buttons (right of screen)**

---

**More**

Touch this button to scroll the data area to the right to view additional columnar data.

**Show Details**

Touch a comm card's entry (row) in the screen and then touch this button to open a report showing the comm number and detailed diagnostic data.

**Reset Counters**

Touch a comm card's entry (row) in the screen and then touch this button to reset the counters for this card's comm port.

## Module Diagnostics - Firmware Upgrade

03/03/2010 02:52 PM		T 1: SETUP DATA WARNING		?		?		?		?		?		
Module Diagnostics - Firmware Upgrade												Install		
Device Directory			Device Assignments			Comm		Firmware Upgrade			◀ ▶			
Address		Module Type		Serial Number		Current Firmware Revision		Available Firmware Revision						
<input type="checkbox"/> B1.S1		IOM - 14		0000000123		001-B		001-B						
<input type="checkbox"/> B1.S2		USM - 16		0008220001		001-B		001-B						

When new software has been installed in the console, newer module firmware may also be included for your console's USM, IOM, MDIM and/or LVDIM modules. This screen lets you check for, and install, newer firmware for each of these modules (see procedure below).

### Report Column Descriptions

#### Address

This column contains the physical address of the device, e.g., B1.S1.

#### Module Type

This column contains the device type, e.g., USM-16 (Universal Sensor Module with 16 inputs).

#### Serial Number

This column contains the device's serial number.

#### Current Firmware Revision

This column contains the current firmware of the device, e.g. 001-A.

### **Available Firmware Revision**

This column contains the available revision of device's firmware, e.g. 001-B. If the current firmware revision is 001-A, and the available firmware revision is 001-B, you can install the latest firmware (B) to this device.

### **Control Buttons (Right side of screen)**

---

#### **Install**

This button is grayed out until you select a module for firmware upgrading by touching the check box beside that module.

#### **Installing a Firmware Upgrade**

1. Touch the check box beside any module that qualifies for upgrade firmware (see Available Firmware Revision paragraph above).
2. The Confirm Download dialog box appears. Touch the OK button. Note: Once the download process is initiated, you cannot cancel the download process nor to revert back to previous revision.

The GUI will display the state of the firmware download status in the status bar or in a separate progress bar dialog box. Following download states will be notified to the user:

- Firmware Download Initiated for 'device'
- Firmware Download In-Progress for 'device'
- Firmware Download Complete for 'device'
- Firmware Download Process completed
- Selected Modules: 'number of modules'; Success: 'number of modules'

## Software Maintenance

### Connecting USB Thumb Drive for Software Maintenance Procedures

Follow the steps below to connect a valid V-R Code/Features USB thumb drive or a V-R Recovery USB thumb drive to the TLS-450 console prior to performing Software Maintenance procedures.

1. Get the USB Adapter and upgrade i-button from the upgrade kit. Remove the plastic end cap from the USB Adapter and Insert the i-button in the adapter as shown in the diagram below:

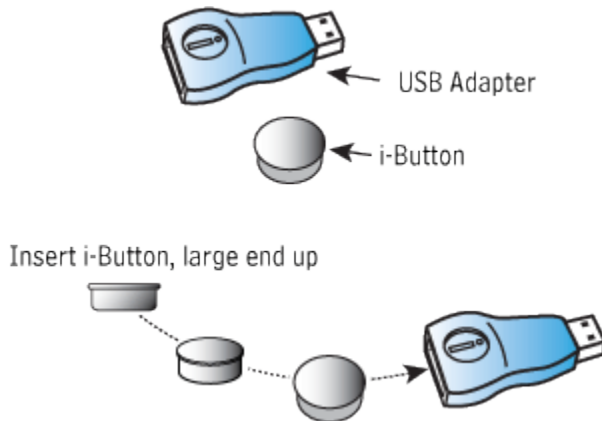

2. Replace the plastic retaining cap on the adapter after inserting the i-Button.
3. Plug the USB Adapter into the USB port of the console's Ethernet/USB card and follow the required Software Maintenance procedures. When you have completed the Software Maintenance procedure(s) remove the thumbdrive.

If the console does not have an Ethernet/USB card, continue to step 4.

4. Turn off power to the console.
5. Using a T-15 Torx driver, remove the two #8 taptite screws the left door of the console (see below):



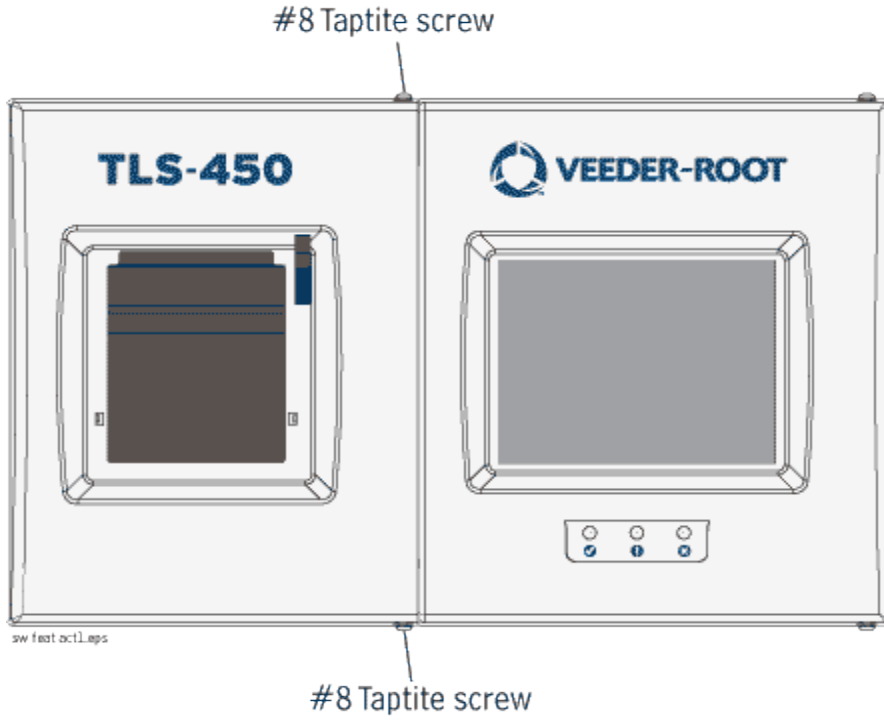

6. Disconnect the Printer's USB cable from its connector on the CPU board and insert the USB Adapter into the CPU connector (see below):

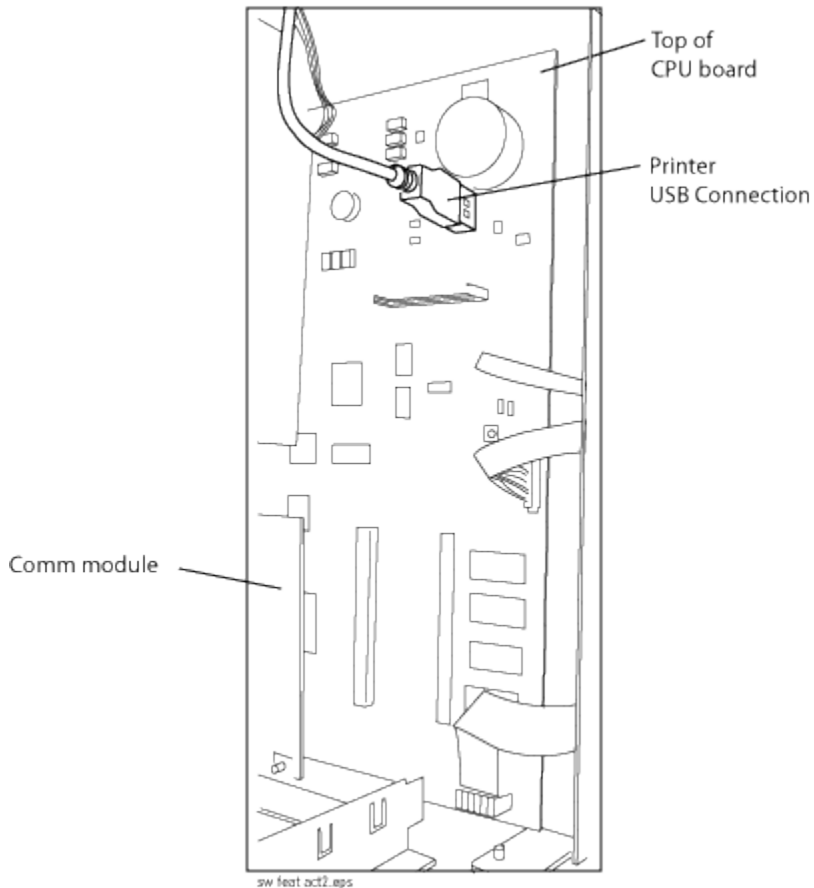

7. Plug the USB Adapter into the CPU board's printer USB port.
8. Close the door.
9. Turn on power to the console and follow the required Software Maintenance procedures. When you have completed the Software Maintenance procedure(s) reverse the steps 4 through 7 above to remove the thumbdrive and reattach the printer cable to its CPU board connector.
10. Close the door and replace the two #8 taptite screws.

## Software Maintenance - Backup Restore

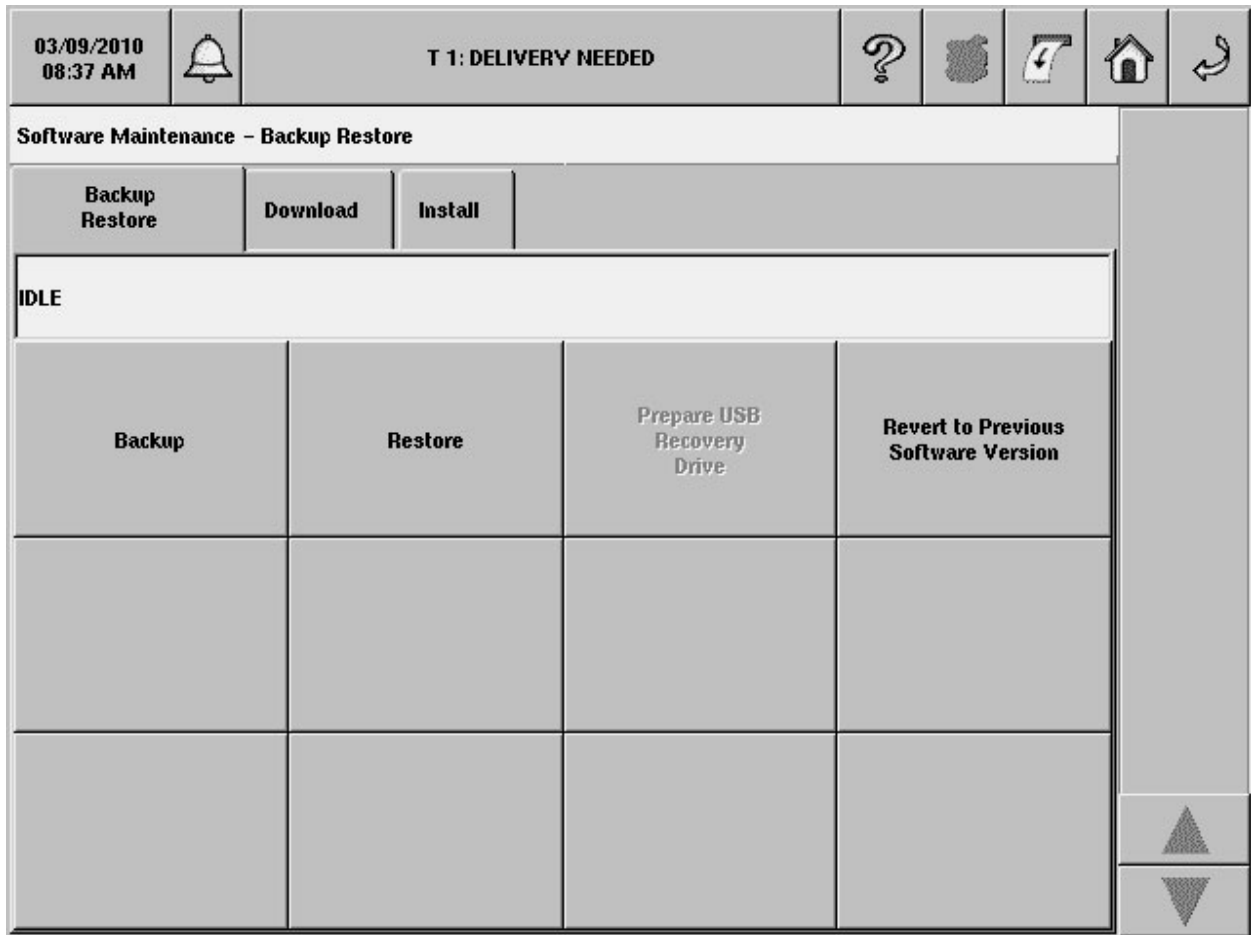

The Backup / Restore screen is used to control console system software/feature/data file backup, restore or revert operations. A valid V-R USB Recovery Thumb Drive is required for backup and recover operations. For ultimate protection against possible loss of data and to protect against system crashes, run the Backup operation daily.

NOTE: It is very important that you keep the V-R Code/Feature and Recovery USB thumb drives in a secure location.

### Backup/Restore Screen Fields and Buttons

#### Status Bar

Displays the current operation in progress. Possible messages include:

- Idle
- Discovering Backup Device
- Backup Operation has started
- Restore Operation in Progress

### **Backup Button**

At regular intervals (ideally once a day), insert your V-R Recovery USB Thumb Drive in the console's USB port and touch this button to launch a non-disruptive backup operation of all system setup and data files.

### **Restore Button**

After replacing a console CF card, or after a system crash, insert your V-R Recovery USB Thumb Drive in a console USB port and touch this button to launch a restore operation that reloads your console's system software, setup and data files from your recovery thumb drive onto the CF card. The Restore operation requires a 'quiet' station as it will cause an interruption in service. The console will be restarted before the Restore has completed.

### **Revert To Previous Software Version Button**

A copy of the previous (older) system software and databases is stored on your console's CF card. If the current (newer) version of system software/features does not perform properly, the Revert-To operation gives you the ability to revert to the previous software version stored in the CF card. The Revert-To operation requires a 'quiet' station as it will cause an interruption in service for about a minute. No USB devices are required for this operation.

After touching this button, a dialog box will alert you that this operation will cause an interruption in service. If you reply with 'OK', the console will then check to ensure a previous version of the applications exists, perform the Revert-To operation, notify you of its successful completion and restart the console. If the Revert-To operation cannot be performed, a dialog box will display an error message.

## Software Maintenance - Download

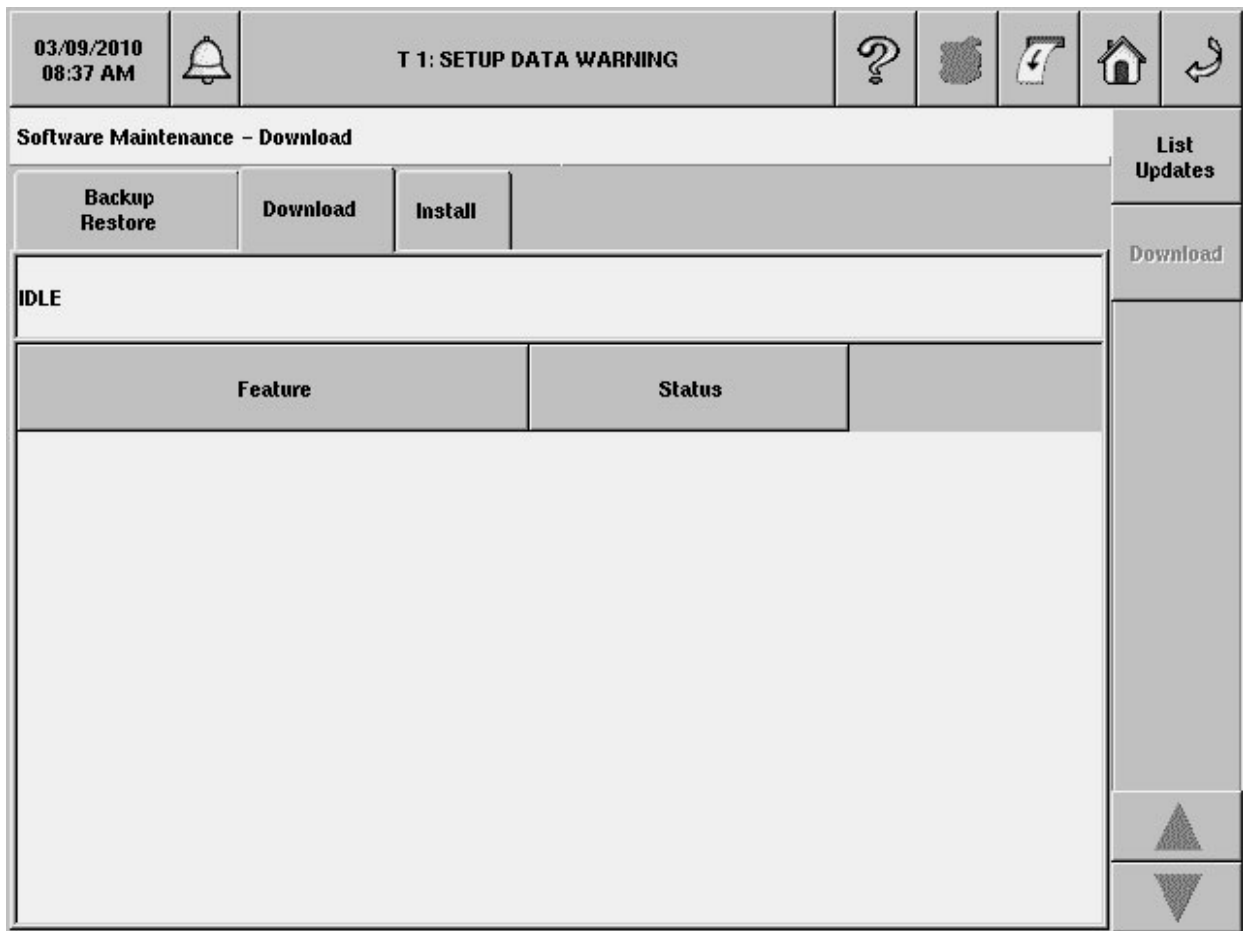

The Download tab screen is used to control USB downloads from either a valid V-R Code/Features USB thumb drive or a V-R Recovery USB thumb drive that is plugged into a USB port in the console.

### Download Procedure

When the Download tab is selected, the USB will automatically be queried for updates that are available. 'Reading Update List' is displayed in the status bar while the list is being acquired. When the list is acquired, the status bar will display 'Waiting selection'. Updates and statuses will be displayed in the Feature/Status columns. Multiple updates may be selected.

The 'List Updates' button will query for available updates and provide a list in the Feature column. When the list is acquired, a check will be made to see which updates have already been installed. A check will be made to see if a compatibility problem exists for any update. If a version compatibility problem exists, a dialog box will be displayed instructing you to contact customer service to obtain the proper version.

Touch the box beside one or more of the desired selection(s) in the Feature column that you want to download. Touch the Download button and the screen's status bar will read 'Downloading'. If pending updates are already on the CF card and were never activated, you will be asked if you want to delete the

pending updates, or to abort the operation. When the download is complete, the screen will display a dialog box notifying you of the results of the download and the status bar will return to 'Waiting Selection'.

NOTE: keep V-R Code/Feature and Recovery USB thumb drives in a secure location.

## **Download Screen Fields and Buttons**

---

### **Status Bar**

Displays the current operation in progress. Possible messages include:

- Reading Update List
- Waiting Selection
- Downloading

### **Feature**

Touch the boxes beside each of the desired items in this column. If you change your mind about a selection, touch the box again to remove the check.

### **Status**

This column lists the current status of each feature in the Software column with one of the following messages:

- Downloaded
- Ready to Download
- Incompatible

## **Control Buttons (Right Side of Screen)**

---

### **List Updates**

Touch to query for available updates.

### **Download**

Touch to download the selected (checked) software. This button is inactive until the thumb drive's contents are validated.

## Software Maintenance - Install

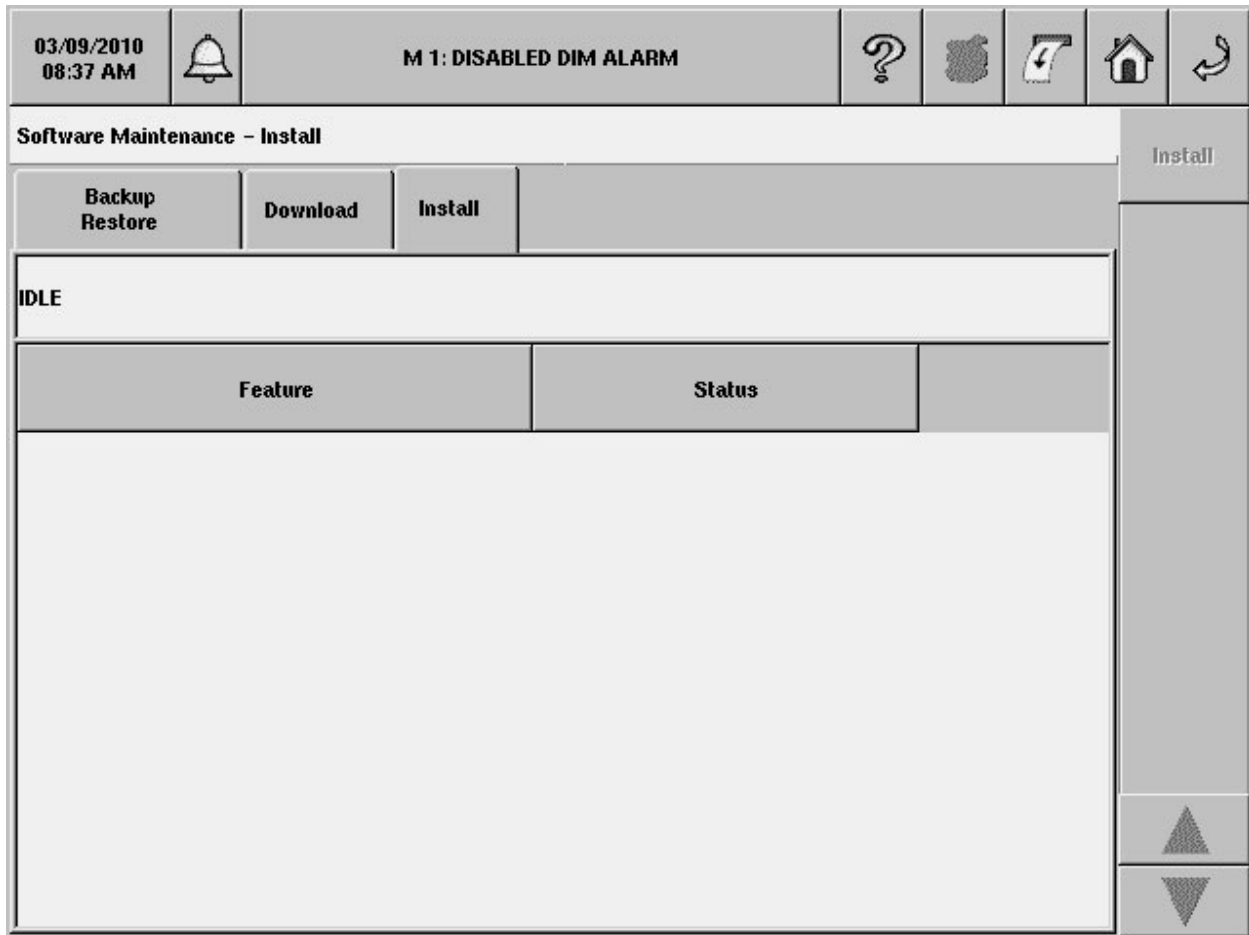

The Install tab screen is used to control the installation of downloaded software. During the installation process, several dialog boxes will be displayed to inform you of key events.

During Installation there must be no dispensing. However, the installation process only takes a few minutes. Following installation, the console converts the setup databases. If new features are installed and activated, setup(s) relevant to the new feature(s) will be required.

### Installation Procedure

1. Touch the features on the list you want to install and then touch the Install button on the right side of the screen.
2. Touch the OK button on the System Restart dialog box, or touch Cancel to abort the installation or to reselect the feature(s) you want to install. The console will restart with the newly installed features.
3. If you used the USB port of the Ethernet/USB module to install the new features, remove the USB Adapter and put it in a safe place. Perform setup for the newly installed features.
4. If you used the CPU board printer's USB port to install the new features, turn off power to the console. Open the left door of the console and remove the USB Adapter from the printer port and reconnect the Printer cable. Close the left door and replace the two #8 tap screws. Turn on power to the console and perform setup for the newly installed features.

## **Install Screen Fields**

---

### **Status Bar**

Displays the current operation in progress. Possible messages include:

- Idle
- Scanning Devices
- Reading Update List
- Waiting Selection
- Downloading

### **Feature**

This column contains a list of features which are available to be installed. Multiple features may be installed concurrently. Touch the boxes beside each of the desired items in this column. If you change your mind about a selection, touch the box again to remove the check.

### **Status**

The current status of each feature is also displayed with one of the following messages:

- Ready to Install
- Installation in Progress

## **Control Button (Right Side of Screen)**

---

### **Install**

Touch to install a selected (checked) feature. This button is inactive until at least one entry has been selected.



## About

### About - System Screen

03/09/2010 08:48 AM		T 1: DELIVERY NEEDED					
<b>About - System</b>							
<b>System</b>							
<b>Software: Part #</b>				342002.A.121.2			
<b>Created</b>				Feb 21 2010 15:58:17			
<b>Hardware Description</b>				<b>Serial #</b>			
-----							
<b>CPU</b>				YYWWXXXX			
<b>iButton</b>				000000f3c9500b			
<b>INPUT/OUTPUT MODULE (B1.S1)</b>				123			
<b>UNIVERSAL SENS MODULE (B1.S2)</b>				8220001			
<b>INPUT/OUTPUT MODULE (B8.S5)</b>				4278190081			
<b>Installed Features</b>							
-----							
<b>Total Control</b>							
* Email Notification							
* Custom On-Board Help							
* Custom Alarms							
* Custom Dashboard							
<b>TLS-450 Direct Access™ Software/Web Browser</b>							
<b>Business Inventory Reconciliation</b>							
<b>AccuChart II</b>							
<b>Continuous Statistical Leak Detection</b>							
<b>Ultimate Testing Leak Detection For DPLLD</b>							
<div style="text-align: right;">   </div>							

The About - System tab screen displays important information about your console's software version and installed features. If you should be experiencing problems with the console, please have the information on this screen available with you before calling.

The Veeder-Root Technical Support number is (800) 323-1799.

## SPECIALTY DIALOG SCREENS

### Alpha Keypad Dialog

The Alpha Keypad Dialog lets you enter letters of the alphabet for labels, names, etc.\

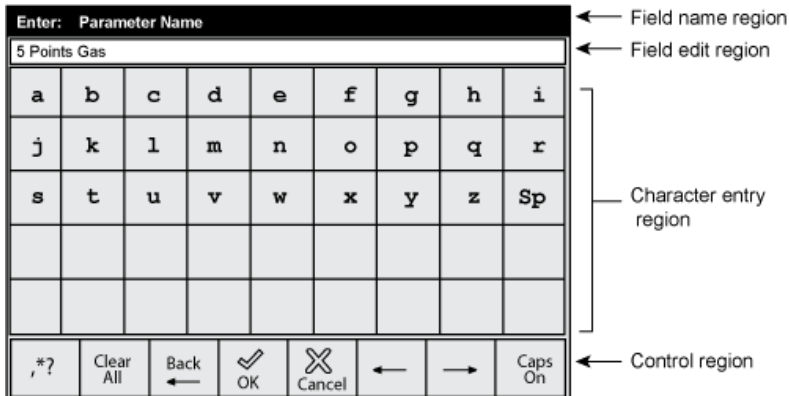

- **Field Name Region**

This is the title area that displays the name of the field value being entered.

- **Field Edit Region**

This is the view area to show the value as it is being entered (entries are left justified).

- **Character Entry Region**

This region has Buttons that enter characters in the Field Edit Line.

- **Control Region**

The region has the following buttons, from left to right:

- ,\*? - touch this button to toggle between the Enhanced Numeric and Alpha keypad interfaces. It is enabled when the field is an Alphanumeric Entry. It is disabled if the field is an Alpha only entry.
- Clear All - touch this button to clear the entire entry.
- Back - touch this button to remove a character to the left of the cursor.
- OK - touch this button to apply the selection.
- Cancel - touch this button to discard any selections that have been made.
- ← - touch this button to move the cursor to the left.
- → - touch this button to move the cursor to the right.
- Caps On - touch this button to turn on or off caps.

## Enhanced Numeric Keypad Dialog

The Enhanced Numeric Keypad Dialog provides characters that contain numeric and punctuation characters used by the alpha numeric fields for the currently selected language. This dialog is used to enter alpha numeric fields and special alpha numeric fields like phone numbers, IP addresses, etc.

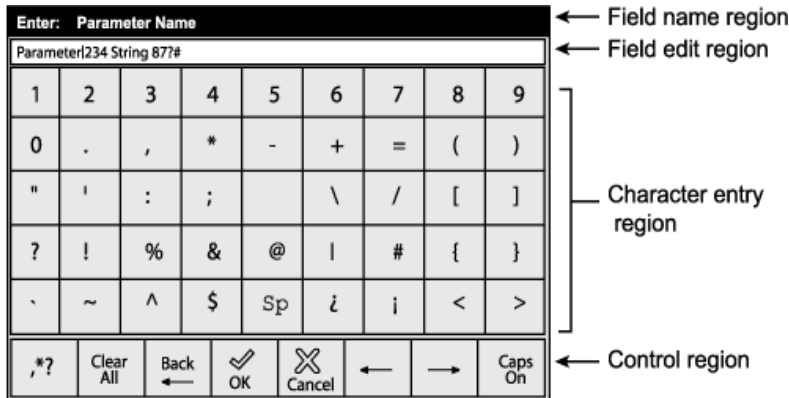

- Field Name Region**  
 This is the title area that displays the name of the field value being entered.
- Field Edit Region**  
 This is the view area to show the value as it is being entered (entries are left justified). The text will be left justified for both alphanumeric and enhanced numeric entries and right justified for both numeric and hexadecimal entries.
- Character Entry Region**  
 This region has Buttons that enter characters in the Field Edit Line. The 'Sp' button enters a Space Character.
- Control Region**  
 The region has the following buttons, from left to right:  
 ,\*? - touch this button to toggle between the Enhanced Numeric and Alpha keypad interfaces. It is enabled when the field is an Alphanumeric Entry. It is disabled if the field is an Alpha only entry.  
**Clear All** - touch this button to clear the entire entry.  
**Back** - touch this button to remove a character to the left of the cursor.  
**OK** - touch this button to apply the selection.  
**Cancel** - touch this button to discard any selections that have been made.  
 ← - touch this button to move the cursor to the left.  
 → - touch this button to move the cursor to the right.  
**Caps On** - touch this button to turn on or off caps.

NOTE: The '¿' and '¡' symbols and other language specific punctuation characters will only show up for languages that need them.

## Numeric Keypad Dialog

The Numeric Keypad dialog will display when you are required to enter integer and decimal entries:

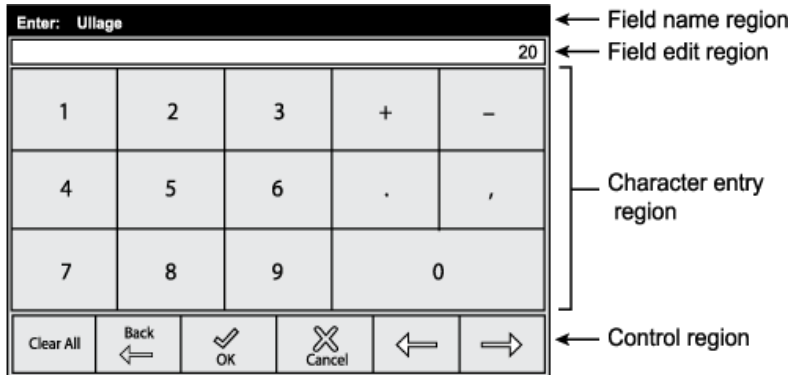

- **Field Name Region**

This is the title area that displays the name of the field value being entered.

- **Field Edit Region**

This is the view area to show the value as it is being entered (entries are right justified).

- **Character Entry Region**

This region has Buttons that enter characters in the Field Edit Line.

- **Control Region**

The region has the following buttons, from left to right:

- **Clear All** - touch this button to clear the entire entry.
- **Back** - touch this button to remove a character to the left of the cursor.
- **OK** - touch this button to apply the selection.
- **Cancel** - touch this button to discard any selections that have been made.
- ← touch this button to move the cursor to the left.
- → touch this button to move the cursor to the right.

Notes:

- Touching '+' and '-' buttons will toggle the sign of the number between positive and negative. The negative sign character will be shown to the left of the numeric entry. The positive sign will not be shown. It will be disabled if range for value does not include negative numbers.
- Touching the ',' button will insert a comma for entries that use thousands separators. This button will be enabled or disabled based on the thousands separator setting in number format section of Display Setup.

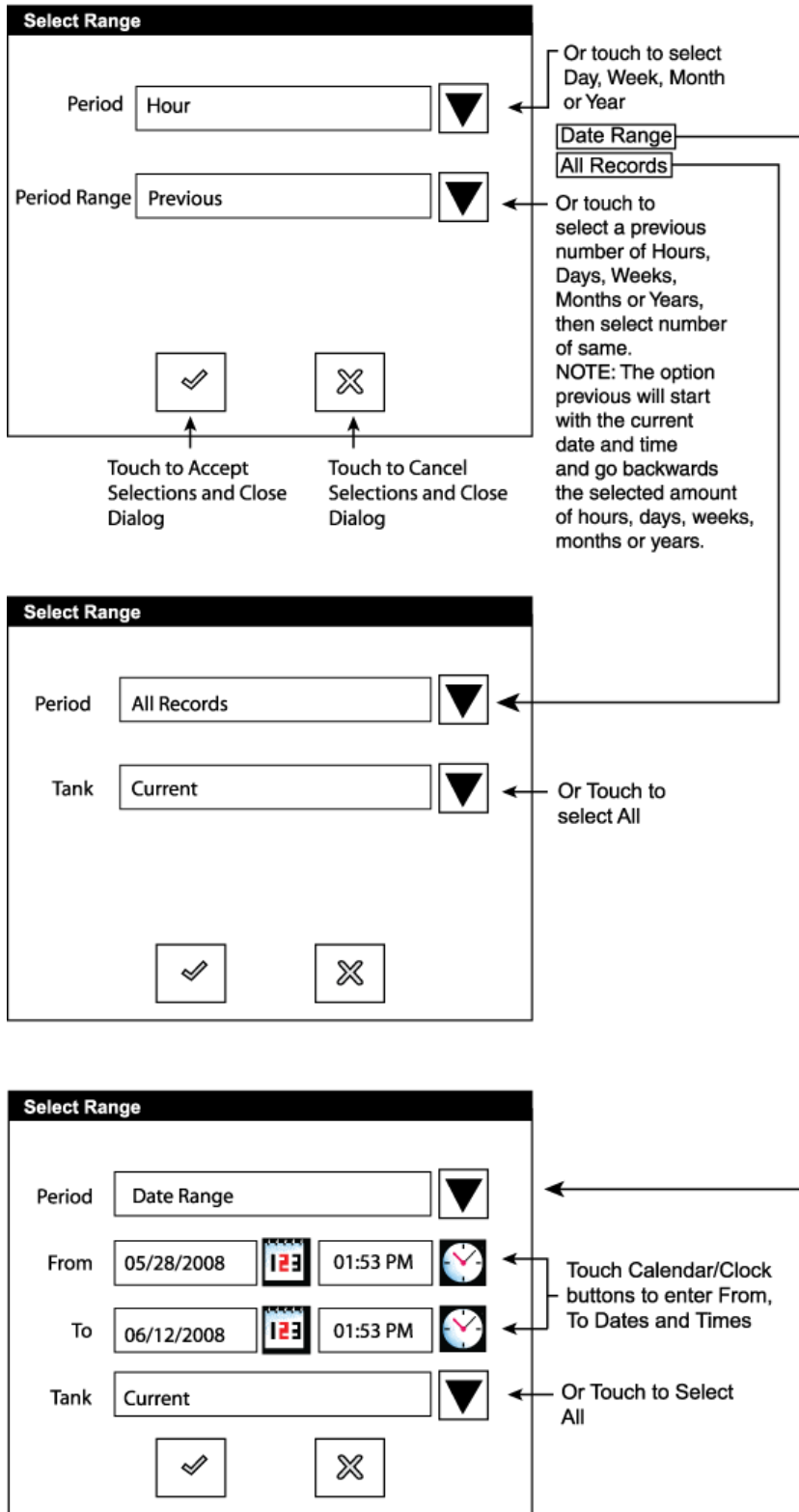

## Report Range Selection Dialogs

The dialog boxes used to define a report's content are shown below.



## PERIODIC MAINTENANCE CHECKLIST

Veeder-Root environmental monitoring consoles installed in accordance with installation manual requirements are designed to detect and report conditions that inhibit proper operation. Veeder-Root consoles self-diagnose essential components, and if a component failure is detected, will not complete and report tank and line tests. The console will issue an audible and visual alarm when a failed or disconnected sensor is detected (NOTE! The audible alarm may have been disabled in Custom Alarm Setup).

<b>⚠ WARNING!</b>	
	<b>This system operates near highly combustible fuel storage tanks. Leaking tanks can create serious environmental and health hazards.</b>
	<b>If you have not been trained in proper service procedures and hazards involved, refer all service to a qualified Veeder-Root Service Representative.</b>
	<b>Attempting to service tank monitors and equipment without proper training can cause damage to property, environment, resulting in personal injury or death.</b>

The Periodic Maintenance Checklist below, if followed, may extend the life of the system, but is not required for proper operation.

Maintenance Operation	When to Perform	What To Do
Console	Yearly	<b>A. Owner or Station Attendant</b> <ol style="list-style-type: none"> <li>1. During or immediately after running a 3.0 gph (11.3 lph) self-test, visually inspect the flexible fuel lines for leakage.</li> <li>2. Check flexible fuel control lines for any chafing or excessive corrosion.</li> </ol> <b>B. Service Contractor</b> <ol style="list-style-type: none"> <li>1. Verify epoxy kits have been installed on field wiring.</li> </ol>
Console	Yearly	<ol style="list-style-type: none"> <li>1. Check printer for paper if equipped.</li> <li>2. Print out or check system inventory and verify to actual inventory.</li> <li>3. Verify in-tank tests are being performed as required by printing reports.</li> <li>4. reports.</li> <li>5. Press Alarm/Test button to verify power, warning and alarm indicators light and audible alarm sounds.</li> </ol>

Maintenance Operation	When to Perform	What To Do
		6. Verify line leak tests are being performed (if line leak installed).
Mag Probes	Yearly	<p><b>A. Owner or Station Attendant</b></p> <ol style="list-style-type: none"> <li>1. Inspect probe cables for any cracking or swelling.</li> </ol> <p><b>B. Service Contractor</b></p> <ol style="list-style-type: none"> <li>1. Replace probe cables (ref. item A.1).</li> <li>2. Verify epoxy kits have been installed on field wiring.</li> <li>3. Mag probes only - Inspect floats and probe shaft for any residue build up. Clean with mineral spirits as necessary.</li> </ol> <p>NOTE: Mag Probes used in products such as waste oil should be checked more frequently than yearly since products of this type can leave deposits on the probe shaft and float assemblies that may restrict the probe's measurement capability.</p>
PLLD	Yearly	<p><b>A. Owner or Station Attendant</b></p> <ol style="list-style-type: none"> <li>1. Check submersible pump head for leakage at PLLD transducer port and functional element with pump On.</li> <li>2. Check PLLD transducer cable for any cracking or damage.</li> </ol> <p><b>B. Service Contractor</b></p> <ol style="list-style-type: none"> <li>1. Verify epoxy kits have been installed on field wiring.</li> <li>2. Replace PLLD transducer if cable is cracked or damaged (ref. item A.2).</li> </ol>
Dispenser Pan, Containment Sump, and Piping Sump Sensor (float type)	Yearly	<p><b>A. Owner or Station Attendant</b></p> <ol style="list-style-type: none"> <li>1. Inspect sensors to verify float moves freely.</li> <li>2. Turn sensor upside down to verify the monitor liquid alarm is activated.</li> <li>3. Inspect sensor cable for any cracking or damage.</li> </ol> <p><b>B. Service Contractor</b></p> <ol style="list-style-type: none"> <li>1. Verify epoxy kits have been installed on field wiring.</li> <li>2. Replace Dispenser Pan/Containment Sump sensor cables if cracked or damaged. Replace Piping Sump sensor if cable is cracked or damaged (ref. item A.3).</li> </ol>

Maintenance Operation	When to Perform	What To Do
Dispenser Pan Sensor (Solid-State)	Yearly	<p><b>A. Owner or Station Attendant</b></p> <ol style="list-style-type: none"> <li>1. Inspect sensor cable for any cracking or damage.</li> <li>2. Verify sensor is firmly secured in an upright position on the bottom of the pan.</li> </ol> <p><b>B. Service Contractor</b></p> <ol style="list-style-type: none"> <li>1. Verify epoxy kits have been installed on field wiring.</li> <li>2. Replace sensor cable if cracked or damaged (ref. item A.1).</li> </ol>
Containment Sump Sensor (Solid-State)	Yearly	<p><b>A. Owner or Station Attendant</b></p> <ol style="list-style-type: none"> <li>1. Inspect sensor cable for any cracking or damage.</li> <li>2. Verify sensor is firmly secured in an upright position on the bottom of the containment sump.</li> </ol> <p><b>B. Service Contractor</b></p> <ol style="list-style-type: none"> <li>1. Verify epoxy kits have been installed on field wiring.</li> <li>2. Replace sensor cable if cracked or damaged (ref. item A.1).</li> </ol>
Vapor Sensor	Yearly	<p><b>A. Owner or Station Attendant</b></p> <ol style="list-style-type: none"> <li>1. Inspect sensor cable for any cracking or damage.</li> </ol> <p><b>B. Service Contractor</b></p> <ol style="list-style-type: none"> <li>1. Verify epoxy kits have been installed on field wiring.</li> <li>2. Replace sensor cable if cracked or damaged (ref. item A.1).</li> </ol>
Groundwater Sensor	Yearly	<p><b>A. Owner or Station Attendant</b></p> <ol style="list-style-type: none"> <li>1. Inspect sensor cable for any cracking or damage.</li> <li>2. Lift sensor above water level in the well and verify the system activates a 'WATER OUT' alarm.</li> </ol> <p><b>B. Service Contractor</b></p> <ol style="list-style-type: none"> <li>1. Verify epoxy kits have been installed on field wiring.</li> <li>2. Replace sensor if cable is cracked or damaged (ref. item A.1).</li> <li>3. If the sensor does not alarm (ref. item A.2), replace the sensor.</li> </ol>
Hydrostatic Sensor	Yearly	<p><b>A. Owner or Station Attendant</b></p> <ol style="list-style-type: none"> <li>1. Inspect sensor cable for any cracking or damage.</li> </ol> <p><b>B. Service Contractor</b></p> <ol style="list-style-type: none"> <li>1. Remove sensor from brine reservoir and verify floats move freely. With</li> </ol>



Maintenance Operation	When to Perform	What To Do
		<p>sensor in its upright position, the system should activate a 'FUEL ALARM'. Turn the sensor upside down to be sure the system activates a 'WATER ALARM'. If the sensor does not alarm in both conditions, replace the sensor.</p> <ol style="list-style-type: none"> <li>2. Verify epoxy kits have been installed on field wiring.</li> <li>3. Replace sensor if cable is cracked or damaged (ref. item A.1).</li> </ol>
Mag Sensor	Yearly	<p><b>A. Owner or Station Attendant</b></p> <ol style="list-style-type: none"> <li>1. Inspect sensor cable for any cracking or damage.</li> <li>2. Check that sensor is resting firmly on bottom of monitored pan/sump.</li> </ol> <p><b>B. Service Contractor</b></p> <ol style="list-style-type: none"> <li>1. Replace Mag Sensor cable if cracked or damaged (ref. item A.1).</li> <li>2. Verify epoxy kits have been installed on field wiring.</li> </ol>

## REFERENCES

### DIM Information Tables

**DIM Quick Reference Table**

DIM P/N	SOFTWARE REV	PROTOCOL	HARDWARE TYPE	DEFAULT SETTINGS				NOTES	PASS THRU
				BAUD	PARITY	LENGTH	STOP		
330280-401	349643	Gilbarco GSite	EDIM	1200	Even	7	1	7	-----
330404-020	349634	Gilbarco CL	CDIM	Proprietary				1, 7	No
331354-001	331353	Tokheim 67A&B	CDIMII	9600	None	8	1	1, 4, 6	No
330280-201	330384	Tokheim DHC	EDIM	1200	Even	7	1	5	-----
330404-010	349633	Wayne CL	CDIM	Proprietary				1, 7	No
330404-001	330435	Schlumberger	CDIM	1200	Even	7	2	2, 5	No
330404-002	331274	Schlumberger SAM	CDIM	4800	Odd	7	1	-----	No
331001-002	349753	Gasboy RS422	LDIM	9600	None	8	1	-----	-----
331001-003	349753	Gasboy CFN	LDIM	9600	None	8	1	5	-----
330280-001	330273	V-R Protocol (BIR)	EDIM	9600	Odd	7	1	Metric, 3, 7	-----
331001-003	330270	Mechanical	MDIM	N/A				2	-----
331313-001	330270	Low Volt Mech.	LVDIM	N/A				2	-----
332328-002	349806	Wayne IDPOS	TDIM	N/A				1	-----
332328-003	349806	Smart Crind	TDIM	N/A				1	-----
331001-001	349646	Tominaga	LDIM	19200	Even	8	1	1, 3, 5, 8	-----
330404-040	349633	Bennett	CDIM	4800	Even	8	1	1, 8	No
330280-511	349631	UK Block	EDIM	2400	Even	7	1	2, 8	No
330280-601	349641	Scheidt & Bach	EDIM	1200	None	8	1	2, 8	-----

## TLS-450 Setup and Operation Screens Manual

### NOTES:

1. Parameter string is never required.
2. Will not generate Comm Alarm.
3. Metric is the default setting for unit conversion. Requires 'G' in parameter string for gallon units.
4. A two port CDIM. Normal CDIMs have 3 ports - CDIMII has two ports that monitor two comm channels each.
5. No blending.
6. Use 'P' in parameter string for Tokheim 2+1, 3+1 and 4+1 blending dispensers.
7. DIMs implemented for V402.
8. Non-U.S. DIM.

### DIM Specific Parameters

STRING	DESCRIPTION
GILBARCO GSITE (Pass Through)	
	None
GILBARCO CL	
T	Do not collect cumulative totals
R	Send captured message to TLS (Engr. use only)
W	Transaction field precision is hundredths (thousandths default)
C	Cumulative field precision is hundredths (thousandths default)
TOKHEIM 67A&B	
T	Blender only site - collects only blender messages
R	Send captured message to TLS (Engr. use only)
P	Plus one dispensers at site - use plus one algorithm
TOKHEIM DHC	
T	Tank volume enabled. TLS will report to DHC tank volumes
WAYNE CL	
R	Send protocol to TLS (Engr. use only)
SCHLUMBERGER	
R	Send protocol to TLS (Engr. use only)
SCHLUMBERGER SAM	
T	Send protocol of controller transmit line to TLS (Engr. use only)
R	Send protocol of controller receiver line to TLS (Engr. use only)
GASBOY RS422	
	None
GASBOY CFN	
	None
V-R PROTOCOL (BIR) (Pass Through)	
J	Suppress Comm Alarm
MECHANICAL	
L	Pulse out loop-back signal
	(see <a href="#">Pulse Conversion Parameters Table</a> )
LOW VOLT MECHANICAL	
L	Pulse out loop-back signal
	(see <a href="#">Pulse Conversion Parameters Table</a> )

## TLS-450 Setup and Operation Screens Manual

STRING	DESCRIPTION
	WAYNE IDPOS
	None
	SMART CRIND
	None
	TOMINAGA
	None
	BENNETT
T	Send protocol of controller transmit line to TLS (Engr. use only)
R	Send protocol of controller receiver line to TLS (Engr. use only)
	UK BLOCK
M	Manifold set
	Manifold start (followed by manifold tank numbers)
	SCHEIDT & BACH
	None

### DIM Parameter Definitions

BAUD		PARITY		STOP BITS		DATA BITS		CONVERSION	
STRING	RATE	STRING	TYPE	STRING	BITS	STRING	BITS	STRING	UNITS
B9	9600	N	None	H	1	V	7	G	Gallons
B4	4800	E	Even	S	2	D	8	M	Metric
B2	2400	O	Odd	-----	-----	-----	-----	I	Imperial
B1	1200	-----	-----	-----	-----	-----	-----	-----	-----
B6	600	-----	-----	-----	-----	-----	-----	-----	-----
B3	300	-----	-----	-----	-----	-----	-----	-----	-----
BG	***	-----	-----	-----	-----	-----	-----	-----	-----

### Pulse Conversion Parameters for MDIM

STRING	PULSES PER UNIT VOLUME
P	100 (7697 Pulser)
F	10 (7697 on High Volume Pump)
T	25 (7874 Pulse/Totalizer) MDIM / LVDIM default
Q	2.5 (7874 on High Volume Pump)
A	1/2
S	1
W	250
X	500
Y	1000

### Female D Connector Pin Outs

PIN	FUNCTION
2	Transmit data
3	Receive data
7	Signal ground

## **Table of Acronyms**







<b>Veeder-Root Acronyms</b>	
BIR	Business Inventory Reconciliation
BOL	Bill of Lading
CDIM	Current Loop Dispenser Interface Module
CRLD	Continuous Reconciliation Leak Detect (Tank and Line)
CSLD	Continuous Statistical Leak Detection (Tank)
CSTP	Contained Submersible Turbine Pump
CVLD	Continuous Vapor Leak Detect (ISD)
DCD	Driver Controlled Delivery
DIM	Dispenser Interface Module
EDIM	Electronic DIM
EVR	Enhanced Vapor Recovery (ISD)
HRM	Hourly Reconciliation Monitoring
I/O	Input/Output
iButton	An object that has bit encoded data that controls available features
ILS	Interstitial Level Sensor
ISD	In-Station Diagnostics
LVDIM	Low Voltage Dispenser Interface Module
MAG	MAGnetostrictive technology
MDIM	Mechanical DIM
PLLD	Pressure Line Leak Detection
PMC	Pressure Management Control (ISD)
QPLD	Quiet Period Leak Detect
RJ	Red Jacket (pumps, controls)
SLD	Static Leak Test (Tank)
TLC	Tanker Load Control
TLS	Tank Level Sensor
USM	Universal Sensor Module
<b>Industry Acronyms</b>	
ASC	Authorized Service Contractor
AST	Aboveground Storage Tank
ATG	Automatic Tank Gauge
AWG	American Wire Gauge
BOS	Back office system
C	Closed (relay)
CITLDS	Continuous In-Tank Leak Detection System
CPU	Central Processing Unit
ECS	Environmental Compliance Systems
EPA	Environmental Protection Agency
IPS	Iron Pipe Size
MOC	Major Oil Company

**TLS-450 Setup and Operation Screens Manual**

NEC	National Electric Code
NFPA	National Fire Protection Association
NC	Normally Closed (relay)
NO	Normally Open (relay)
NPT	National Pipe Thread
PMC	Primary Maintenance Contractor
POS	Point of Sale
PRS	Product Requirement Specification
SCLD	Secondary Containment Leak Detection
STP	Submersible Turbine Pump
USB	Universal Serial Bus
<b>Regulatory Acronyms</b>	
ATEX	Europe
BASEEFA	UK
C of C	Certificate of Compliance
CAPCO	The California Air Pollution Control Officers Association
CARB	California Air Resources Board
CEN	Committee European for Normalization (Standardization)
CSA	Canadian Standard Association
D of C	Declaration of Conformance
Lcaa approval	France
LOM approval	Spain
NEPSI	China
NWML	European Weights and Measures
PTB	Germany
SAA	Australia
SEV	Switzerland
TUV	Austria
UL	Underwriters Laboratory

## **Table of Alert Symbols**

Safety and Alert Symbols are used throughout the help files to alert you to important system and safety information. The table below explains symbols you may see when reading the online help setup and operation instructions for this equipment.

<b>Symbol</b>	<b>Definition</b>
	<b>ELECTRICITY</b> High voltage exists in, and is supplied to, the device. A potential shock hazard exists.
	<b>EXPLOSIVE</b> Fuels and their vapors are extremely explosive if ignited.
	<b>FLAMMABLE</b> Fuels and their vapors are extremely flammable.
	<b>TURN POWER OFF</b> Live power to a device creates a potential shock hazard. Turn Off power to the device and associated accessories when servicing the unit.
	<b>WARNING</b> Heed the adjacent instructions to avoid equipment damage or personal injury.
	<b>AUDIBLE ALARM</b> Touch the flashing System Status box to acknowledge the alarm and turn off the beeper!
	<b>READ ALL RELATED MANUALS</b> Knowledge of all related procedures before you begin work is important. Read and understand all manuals thoroughly. If you do not understand a procedure, ask someone who does.

## Table of Device Identifiers

Device Type	Short Device Identifier	Long Device Identifier	Full Device Identifier
Air Flow Meter	Af	AfMeter	Air Flow Meter
Atmospheric Sensor	At	AtmSns	Atmospheric Sensor
Automatic Event	Ae	AutoEvt	-----
Contact	Cn	Contact	-----
Comm Device	Co	Comm	Comm Device
Dispenser	d	Disp	Dispenser
EDIM,CDIM,LDIM	E	DIM	EDIM,CDIM,LDIM
External Input	I	ExtInp	External Input
Fueling Position	Fp	FPos	Fueling Position
Ground Water Sensor	G	GrndWtr	Ground Water Sensor
Hose	h	Hose	Hose
Hydrocarbon Sensor	Hy	HydcSns	Hydrocarbon Sensor
Line	Ln	Line	Line
Line Pressure Sensor (PLLD)	PI	LPSensr	Line P Sensor
Liquid Sensor	L	Liquid	Liquid Sensor
Mag Sensor	MS	MAG	Mag Sensor
Meter	m	Meter	Meter
MDIM	M	MDIM	MDIM
Module	Mo	Module	Module
PLLD Line	Q	Line	PLLD Line
Probe	Pb	Probe	Probe
Product	F	Product	Product
Pump	Pm	Pump	Pump
Pump Sense Input	S	PumpSns	Pump Sense Input
Relay	R	Relay	Relay
Siphon Set	Si	Siphon	Siphon Set
Tank	T	Tank	Tank
Type A (2-Wire CL) Sensor	C	Type A	Type A Sensor
Type B (3-Wire CL) Sensor	H	Type B	Type B Sensor
Vacuum Sensor	Vs	VacSns	Vacuum Sensor
Ullage Pressure Sensor	Pv	UVPSns	Ullage Press Sensor
Vapor Sensor	V	Vapor	Vapor Sensor



## **Table of Module Device Identifiers**

<b>Module Type</b>	<b>Short Device Identifier</b>	<b>Long Device Identifier</b>	<b>Full Device Identifier</b>
Universal Sensor Module	UM	USM	Universal Sensor Module
Relay/External Input Module	IO	IOM	Relay/External Input Module

## **Table of Standard Abbreviations**

<b>Word</b>	<b>English Abbreviation</b>
Alarm	Alrm
Average	Avg
Board	brd
Dispense	Disp
Delivery	dlvy or dlv
Evaporation	Evap
Factor	Fact
Height	ht
Interval	Intvl
Minutes	min or MM
Maximum	Max
Product	Prod
Seconds	sec or SS
Status	St
Standard	Stan
Test	tst
Temperature	Temp
Temperature Compensation	TC
Tank	Tnk
Volume	Vol
Warning	Warn
Water	Wtr
Year	YY or YYYY

## **Table of Unit Abbreviations**

<b>Unit</b>	<b>Abbreviation</b>
Gallon	gal
Litre	L
Inch	in
Centimeter	cm
Millimeter	mm
Degrees Fahrenheit	°F
Degrees Celcius	°C
Pounds per Square Inch	psi
Pascal	Pa
Kilo-Pascal	kPa
Foot	ft
Meter	m
Pound	lb
Kilogram	kg
Year	yr or Y (Date format)
Month	mo (Date format)
Day	d or D (Date format)
Hour	h or H (Time format)
Minute	min or MM (Time format)
Second	s or S (Time format)
Percent	%
Gallons	gph
Litres per hour	lph

## Table of Unit Conversions

Unit	Metric to U.S. Conversion	U.S. to Metric Conversion
Capacity	gal = L/3.785	L = gal * 3.7850001
Distance	in = mm/25.4, in = cm/2.54	mm = in * 25.4, cm = in * 2.54
Temperature	°F = ([9/5] * °C) + 32	°C = (5/9) * (°F - 32)
Temperature Change	delta°F = (9/5) * °C	delta°C = (5/9) * delta°F
Pressure	psi = kPa * 0.1451	kPa = psi/0.1451
Distance	ft = m/0.3048	m = ft * 0.3048
Density	lb/gal = kg/m <sup>3</sup> /119.913955	kg/m <sup>3</sup> = lb/gal * 119.913955
Mass	lb = kg/0.4539237	kg = lb * 0.4539237
Capacity/Distance	gal/in = L/cm/(3.785/25.4)	L/cm = gal/in * (3.7850001/25.4)
Thermal Coefficient	gal/gal/°F = (5/9)L/L/°C	L/L/°C = (9/5)gal/gal/°F

1 U.S. gallon = 0.8327 Imperial gallons. 1 Imperial gallon = (1/0.8327) U.S. gallons

## Table of Mag Probe Features

Circuit Code	Probe Name	Name Type	Phase Sep./ Density	Leak Detect	Water Detect
C000	Std, 0.10 GPH, 2-float	MAG1	No	0.10 GPH	Yes
C001	Std, 0.20 GPH, 2-float	MAG2	No	0.20 GPH	Yes
D000	Std, Inv only, 2-float	MAG3	No	None	Yes
D001	Alt, 0.10 GPH, 1-float	MAG4	No	0.10 GPH	No
D002	Alt, 0.20 GPH, 1-float	MAG5	No	0.20 GPH	No
D003	Alt, Inv only, 1-float	MAG6	No	None	No
D004	LRP, 0.10 GPH, 2-float	MAG7	Phase Sep.	0.10 GPH	Yes
D005	LRP, 0.20 GPH, 2-float	MAG8	Phase Sep.	0.20 GPH	Yes
D006	LRP, Inv only, 2-float	MAG9	Phase Sep.	None	Yes
D007	LRP, 0.10 GPH, 1-float	MAG10	No	0.10 GPH	No
D008	LRP, 0.20 GPH, 1-float	MAG11	No	0.20 GPH	No
D009	LRP, Inv only, 1-float	MAG12	No	None	No
D021	GLB, Inv only, 2-float	GLB8	No	None	Yes
D022	GLB, Inv only, 2-float	GLB9	No	None	Yes
D023	GLB, Inv only, 1-float	GLB10	No	None	No
D024	GLB, Inv only, 1-float	GLB11	No	None	No
D041	0.10 GPH	MAG-D	Density	0.10 GPH	Yes
D042	0.20 GPH	MAG-D	Density	0.20 GPH	Yes
D043	Inv only	MAG-D	Density	None	Yes

# Web Access Overview

## Introduction

Veeder-Root's Web Access software lets you monitor the TLS-450 console remotely on your PC anywhere you have internet access. Once connected to the console, you can view many current and historical reports including tank inventory, tank delivery, sensor status, alarm status and compliance in the language and units selected in console setup. Web Access software does not provide access to console setup or diagnostics screens.

All report screens support scrolling and are printable. Screens that have dynamic data will refresh automatically. The refresh rate is dependent on the data viewed.

## System Requirements:

- a. Java Applet enabled in your browser.  
For help enabling the applet go to  
[http://www.java.com/en/download/help/enable\\_browser.xml](http://www.java.com/en/download/help/enable_browser.xml)
- b. JVM version 1.4 or newer installed.  
To download the latest JVM version go to  
<http://java.sun.com/j2se/1.4.2/download.html>

## Connecting to the TLS-450 Console

You need the IP address of the console which can be found in Communications Setup. On the console's Home screen, touch the Setup button, touch the Comm button, touch the down arrow to see the next page of the General Tab Screen and you will see the IP address (of the console) in the IP Address field.

Open Internet Explorer on your PC and enter the IP address of the console followed by /tls.html (lowercase) in the URL bar of the browser as shown below:

`http://xxxx.xxxx.xxxx.xxxx/tls.html`  
(where xxxx.xxxx.xxxx.xxxx = console IP address).

The TLS-450 Web Access home page will display the system status report (see example below):

The screenshot shows the VEEDER-ROOT web interface. At the top, there is a navigation menu with tabs for Home, Reports, Alarms, Tanks, Lines, Sensors, BIR, Diags, RS-232, Setup, and About. The main content area displays the date and time 'MAR 10, 2010 10:12 AM' and the location 'BIG 3 GASOLINE, 123 POWER LN, HELENA, MT 59601'. Below this is a 'SYSTEM STATUS REPORT' table with columns for ID, CATEGORY, DESCRIPTION, ALARM TYPE, STATE, DATE, and TIME. The table lists various alarms such as 'INVALID FUEL LEVEL', 'LOW PRODUCT ALARM', 'DELIVERY NEEDED', 'PROBE OUT', and 'MISSING TICKET WARN'. At the bottom of the interface is a 'Refresh System Status' button.

ID	CATEGORY	DESCRIPTION	ALARM TYPE	STATE	DATE	TIME
T 1	Tank	SUPREME	INVALID FUEL LEVEL	CLEAR	03-09-10	05:04 PM
T 1	Tank	SUPREME	LOW PRODUCT ALARM	CLEAR	03-09-10	02:07 PM
T 3	Tank	REGULAR	DELIVERY NEEDED	CLEAR	03-09-10	01:26 PM
T 2	Tank	REGULAR	DELIVERY NEEDED	CLEAR	03-09-10	11:49 AM
T 1	Tank	SUPREME	DELIVERY NEEDED	CLEAR	03-09-10	09:42 AM
T 2	Tank	REGULAR	PROBE OUT	CLEAR	03-09-10	08:51 AM
T 3	Tank	REGULAR	PROBE OUT	CLEAR	03-09-10	08:51 AM
T 1	Tank	SUPREME	PROBE OUT	CLEAR	03-09-10	08:51 AM
T 3	Tank	REGULAR	LOW PRODUCT ALARM	CLEAR	03-09-10	07:15 AM
T 2	Tank	REGULAR	LOW PRODUCT ALARM	CLEAR	03-09-10	07:01 AM
E 1	DIM		COMMUNICATION ALARM	CLEAR	03-04-10	01:12 PM
T 2	Tank	REGULAR	MISSING TICKET WARN	ALARM	03-01-10	07:08 PM
T 1	Tank	SUPREME	MISSING TICKET WARN	ALARM	03-01-10	06:47 PM

## TLS-450 Web Pages

Click on any of the tabs in the menu bar at the top of the home screen to display the desired page. Viewable pages are as follows (report content is dependent on installed hardware and console features):

- **Reports**
  - Inventory (current)
  - Delivery (Last delivery record per tank)
  - Shift
- **Alarms**
  - Active Alarms (all active alarms in chronological order)
  - Priority Alarms
  - Non-Priority Alarms

- **Tanks**
  - Tank Status (current alarm status per tank)
  - Alarm History
  - Leak Test Results (last gross, periodic, annual test results per tank)
  - Leak Test History
  
- **Lines**
  - Line Status (current PLLD status per line)
  - Alarm History
  - O.2 Test Results
  - 0.2 Test (Results) History
  - 0.1 Test Results
  - 0.1 Test (Results) History
  
- **Sensors**
  - Liquid Sensor
    - Status
    - Alarm History
  - Vapor Sensor
    - Status
    - Alarm History
  - Groundwater Sensor
    - Status
    - Alarm History
  - 2 Wire CL Sensor
    - Status
    - Alarm History
  - 3 Wire CL Sensor
    - Status
    - Alarm History
  - Mag Sensor
    - Status
    - Alarm History
  
- **BIR**
  - Current BIR Report
  - Previous BIR Report
  - Current Book Report
  - Previous Book Report
  - Test Results Report
  
- **Diags**

This page lists hardware/software features about the TLS-450.

## Web Access

- **RS-232**  
This page lets you communicate with the TLS-450 using RS-232 commands.
- **Setup**  
This page lets you enter an access password and set page data refresh rates.
- **About**  
This page displays your installed TLS-450 Web Access software version.

# Web Access Home Page

The TLS-450 Web Home page is shown below:

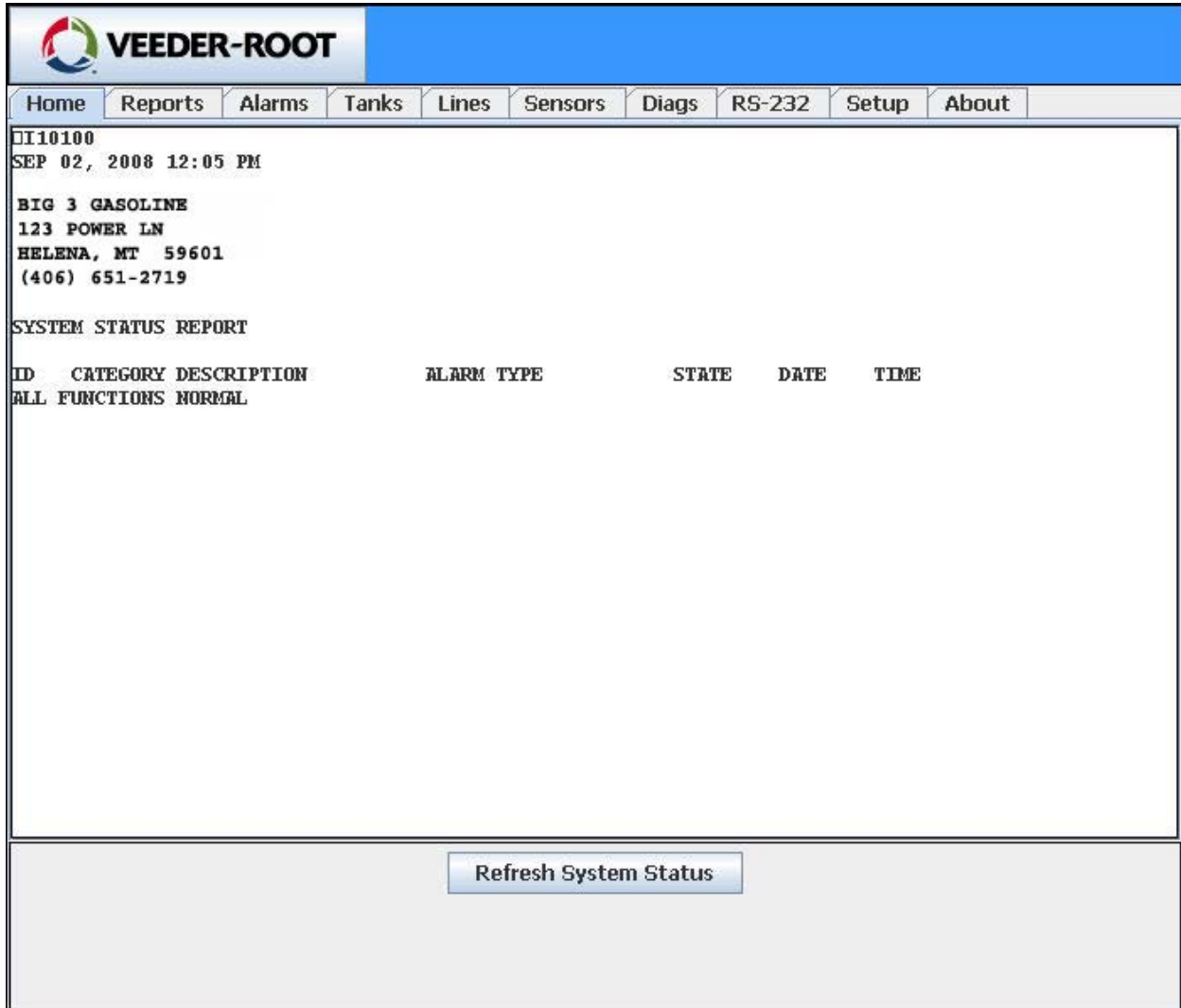

**VEEDER-ROOT**

Home Reports Alarms Tanks Lines Sensors Diags RS-232 Setup About

DI10100  
SEP 02, 2008 12:05 PM

**BIG 3 GASOLINE**  
123 POWER LN  
HELENA, MT 59601  
(406) 651-2719

SYSTEM STATUS REPORT

ID	CATEGORY	DESCRIPTION	ALARM TYPE	STATE	DATE	TIME
ALL	FUNCTIONS	NORMAL				

Refresh System Status

## Refresh System Status Button

Click on this button to refresh the report's contents (applies if new data is available).



# Web Access Reports - Inventory Page

The TLS-450 Web Access Reports - Inventory page example is shown below:

The screenshot displays the VEEDER-ROOT web interface. At the top, there is a navigation menu with buttons for Home, Reports, Alarms, Tanks, Lines, Sensors, Diags, RS-232, Setup, and About. The main content area shows the date and time 'AUG 22, 2008 11:17 AM' and the location 'BIG 3 GASOLINE, 123 POWER LN, HELENA, MT 59601, (406) 651-2719'. Below this, the section 'IN-TANK INVENTORY' contains a table with columns for TANK, PRODUCT, VOLUME TC, VOLUME, ULLAGE, HEIGHT, WATER, and TEMP. The table lists five tanks with their respective fuel types and measurements. At the bottom of the interface, there are three buttons: Inventory, Delivery, and Shift.

TANK	PRODUCT	VOLUME TC	VOLUME	ULLAGE	HEIGHT	WATER	TEMP
1	Regular	3116	3086	31331	1730.97	392.21	22.38
2	Diesel	25008	24683	9440	1530.24		24.90
3	Unleaded	23756	23442	10692	1530.24		25.07
4	Mid-grade	25008	24683	9440	1530.24		24.90
5	Super	25008	24683	9440	1530.24		24.90

# Web Access Reports - Delivery Page

The TLS-450 Web Access Reports - Delivery page example is shown below:



[Home](#) | [Reports](#) | [Alarms](#) | [Tanks](#) | [Lines](#) | [Sensors](#) | [Diags](#) | [RS-232](#) | [Setup](#) | [About](#)

```

II20200
SEP 03, 2008 01:31 PM

BIG 3 GASOLINE
123 POWER LN
HELENA, MT 59601
(406) 651-2719

DELIVERY REPORT

TANK    PRODUCT
 1      Regular 1
INCREASE  DATE / TIME          GALLONS  TC-GALLONS  WATER  TEMP-F  HEIGHT
END: AUG 26, 2008  3:40 PM      5282
START: AUG 26, 2008  3:38 PM      2820
AMOUNT:                                2462

END: AUG 26, 2008  3:19 PM      6580
START: AUG 26, 2008  3:18 PM      5956
AMOUNT:                                624

TANK    PRODUCT
 2      Regular 2
INCREASE  DATE / TIME          GALLONS  TC-GALLONS  WATER  TEMP-F  HEIGHT
END: AUG 26, 2008  3:40 PM      5465
START: AUG 26, 2008  3:38 PM      4127
AMOUNT:                                1338
          
```

## Web Access Reports - Shift Page

The TLS-450 Web Access Reports - Shift page example is shown below:

**VEEDER-ROOT**

Home Reports Alarms Tanks Lines Sensors Diags RS-232 Setup About

II20400  
SEP 02, 2008 12:07 PM

**BIG 3 GASOLINE**  
123 POWER LN  
HELENA, MT 59601  
(406) 651-2719

SHIFT INVENTORY REPORT

TANK PRODUCT  
1 Regular 1

SHIFT 3 [08/09/02 09:15 - 08/09/02 12:07] OPEN

	FUEL VOLUME	FUELTC VOLUME	ULLAGE 100%	ULLAGE 90%	FUEL HEIGHT	WATER HEIGHT	WATER VOLUME	FUEL TEMP
START	5282	5242	2218	1468	31.84	0.00	0	70.83
END	5282	5241	2218	1468	31.84	0.00	0	71.13
DELIVERY	0							
TOTALS	0							

SHIFT 2 [08/09/02 09:10 - 08/09/02 09:15] CLOSED

	FUEL VOLUME	FUELTC VOLUME	ULLAGE 100%	ULLAGE 90%	FUEL HEIGHT	WATER HEIGHT	WATER VOLUME	FUEL TEMP
START	5282	5242	2218	1468	31.84	0.00	0	70.85
END	5282	5242	2218	1468	31.84	0.00	0	70.83
DELIVERY	0							
TOTALS	-0							

Inventory Delivery Shift

Refer to the Inventory Reports - Shift Inventory topic in this manual for more information on this page.

A Delivery Volume entry only appears if a delivery was made during the shift. A Totals Volume entry only appears if a delivery was made during the shift (Totals = start volume - end volume + delivery volume). The Totals row will only show zero if there are no deliveries AND the start volume = end volume [i.e. no fuel was dispensed]).

# Web Access Active Alarms Page

The TLS-450 Web Access Active Alarms page is shown below:

**VEEDER-ROOT**

Home Reports **Alarms** Tanks Lines Sensors Diags RS-232 Setup About

DI11300  
SEP 02, 2008 12:08 PM

BIG 3 GASOLINE  
123 POWER LN  
HELENA, MT 59601  
(406) 651-2719

ACTIVE ALARM REPORT

ID	CATEGORY DESCRIPTION	ALARM TYPE	DATE	TIME
----	----------------------	------------	------	------

Active Alarms Priority Alarms Non-Priority Alarms

# Web Access Priority Alarms Page

The TLS-450 Web Access Priority Alarms page example is shown below:

**VEEDER-ROOT**

Home Reports **Alarms** Tanks Lines Sensors Diags RS-232 Setup About

DI11100  
SEP 02, 2008 12:09 PM

**BIG 3 GASOLINE**  
123 POWER LN  
HELENA, MT 59601  
(406) 651-2719

**PRIORITY ALARM HISTORY**

ID	CATEGORY	DESCRIPTION	ALARM TYPE	STATE	DATE	TIME
T 2	Tank	Regular 2	SUDDEN LOSS ALARM	CLEAR	08-26-08	3:38 PM
T 2	Tank	Regular 2	SUDDEN LOSS ALARM	ALARM	08-26-08	3:35 PM

Active Alarms **Priority Alarms** Non-Priority Alarms

## Web Access Non-Priority Alarms Page

The TLS-450 Web Access Non-Priority Alarms page example is shown below:



Home
Reports
Alarms
Tanks
Lines
Sensors
Diags
RS-232
Setup
About

DI11200  
SEP 02, 2008 12:09 PM

**BIG 3 GASOLINE**  
123 POWER LN  
HELENA, MT 59601  
(406) 651-2719

**NON-PRIORITY ALARM HISTORY**

ID	CATEGORY	DESCRIPTION	ALARM TYPE	STATE	DATE	TIME
T 1	Tank	Regular 1	NO CSLD IDLE TIME	CLEAR	08-29-08	4:10 PM
T 1	Tank	Regular 1	NO CSLD IDLE TIME	ALARM	08-29-08	3:53 PM
Ae 3	AutoEvt		SETUP DATA WARNING	CLEAR	08-20-08	3:48 PM
Ae 3	AutoEvt		SETUP DATA WARNING	ALARM	08-20-08	11:38 AM

Active Alarms
Priority Alarms
Non-Priority Alarms

# Web Access Tanks - Status Page

The TLS-450 Web Access Tanks - Status page example is shown below:

The screenshot displays the Veeder-Root web interface. At the top left is the Veeder-Root logo. A navigation bar contains the following menu items: Home, Reports, Alarms, Tanks, Lines, Sensors, Diags, RS-232, Setup, and About. The main content area shows the following information:

DI20500  
SEP 02, 2008 12:10 PM

**BIG 3 GASOLINE**  
123 POWER LN  
HELENA, MT 59601  
(406) 651-2719

**TANK STATUS REPORT**

TANK	PRODUCT	STATUS
1	Regular 1	NORMAL
2	Regular 2	NORMAL
3	Super	NORMAL
4	Diesel	NORMAL

At the bottom of the interface, there are four buttons: Tank Status, Alarm History, Leak Test Results, and Leak Test History.

## Web Access Tanks - Alarm History Page

The TLS-450 Web Access Tanks - Alarm History page example is shown below:

**VEEDER-ROOT**

Home Reports Alarms **Tanks** Lines Sensors Diags RS-232 Setup About

DI20600  
SEP 02, 2008 12:10 PM

**BIG 3 GASOLINE**  
123 POWER LN  
HELENA, MT 59601  
(406) 651-2719

**TANK ALARM HISTORY**

**TANK 1 Regular 1**

NO CSLD IDLE TIME	AUG 29, 2008 3:53 PM
PERIODIC TEST FAIL	AUG 22, 2008 6:00 AM
GROSS TEST FAIL	AUG 18, 2008 2:28 PM

**TANK 2 Regular 2**

SETUP DATA WARNING	AUG 26, 2008 3:38 PM
SUDDEN LOSS ALARM	AUG 26, 2008 3:35 PM
	AUG 26, 2008 2:46 PM

**TANK 3 Super**

HIGH WATER WARNING	AUG 28, 2008 10:25 AM
--------------------	-----------------------

**TANK 4 Diesel**

Tank Status Alarm History Leak Test Results Leak Test History



# Web Access Tanks - Leak Test Results Page

The TLS-450 Web Access Tanks - Leak Test Results page example is shown below:

**VEEDER-ROOT**

Home Reports Alarms Tanks Lines Sensors Diags RS-232 Setup About

DI20800  
SEP 03, 2008 03:20 PM

**BIG 3 GASOLINE**  
123 POWER LN  
HELENA, MT 59601  
(406) 651-2719

PREVIOUS IN TANK LEAK TEST RESULTS

TANK 1 Regular 1

TEST TYPE	START TIME	RESULT	LEAK RATE	Hrs	VOLUME	REASON
Periodic	SEP 3, 2008 4:00	AMInvalid	0.00	2	5248	Level increase
Gross	SEP 3, 2008 4:00	AMPassed	0.28		5248	

TANK 2 Regular 2

TEST TYPE	START TIME	RESULT	LEAK RATE	Hrs	VOLUME	REASON
NO TESTS AVAILABLE						

TANK 3 Super

TEST	LEAK

Tank Status Alarm History Leak Test Results Leak Test History

# Web Access Tanks - Leak Test History Page

The TLS-450 Web Access Tanks - Leak Test History page example is shown below:

**VEEDER-ROOT**

Home Reports Alarms Tanks Lines Sensors Diags RS-232 Setup About

DI20700  
SEP 03, 2008 03:21 PM

**BIG 3 GASOLINE**  
123 POWER LN  
HELENA, MT 59601  
(406) 651-2719

**TANK LEAK TEST HISTORY**

T 1: Regular 1

REPORT TYPE	DATE/TIME	METHOD	HOURS	AVERAGE VOLUME	% VOLUME
LAST GROSS	08/09/03 14:23	SLD		5240	69.9
LAST PERIODIC	08/09/02 04:00	SLD	2	5246	70.0
FULLEST PERIODIC	08/09/01 04:00	SLD	2	5249	70.0
FULLEST PERIODIC	08/09/01 00:14	CSLD	13	5250	70.0
FULLEST PERIODIC	08/08/31 07:41	CSLD	12	5255	70.1
FULLEST PERIODIC	08/08/25 04:00	SLD	2	5922	79.0

T 2: Regular 2

REPORT TYPE	DATE/TIME	METHOD	HOURS	AVERAGE VOLUME	% VOLUME

T 3: Super

AVERAGE VOLUME	% VOLUME

Tank Status Alarm History Leak Test Results Leak Test History

## Web Access Lines - Line Status

The TLS-450 Web Access Lines - Line Status page example is shown below:

**VEEDER-ROOT**

Home Reports Alarms Tanks Lines Sensors Diags RS-232 Setup About

SEP 12, 2008 04:34 PM

BIG 3 GASOLINE  
123 POWER LN  
HELENA, MT 59601  
(406) 651-2719

PRESSURE LINE LEAK STATUS

LINE	DISPENSING	TEST STATUS	PUMP	HANDLE
Ln 1: UNLEAD	ENABLED	testing at 3.00 GAL/HR	OFF	OFF

ACTIVE ALARMS:

Ln 2: ULTRA	ENABLED	test complete	OFF	OFF
-------------	---------	---------------	-----	-----

ACTIVE ALARMS:

Line Status Alarm History

0.2 Test Results 0.1 Test Results

0.2 Test History 0.1 Test History

# Web Access Lines - Alarm History Page

The TLS-450 Web Access Lines - Alarm History page example is shown below:

**VEEDER-ROOT**

Home Reports Alarms Tanks Lines Sensors Diags RS-232 Setup About

DI38100  
 SEP 02, 2008 12:11 PM

**BIG 3 GASOLINE**  
 123 POWER LN  
 HELENA, MT 59601  
 (406) 651-2719

PRESSURE LINE LEAK STATUS

LINE	DISPENSING	TEST STATUS	PUMP	HANDLE
Q 1: Regular 1	DISABLED	test aborted	OFF	OFF

ACTIVE ALARMS:

Line Status Alarm History

0.2 Test Results 0.1 Test Results

0.2 Test History 0.1 Test History

## Web Access Lines - 0.2 Test Results Page

The TLS-450 Web Access Lines - 0.2 Test Results page example is shown below:

The screenshot displays the Veeder-Root web interface. At the top left is the Veeder-Root logo. A navigation menu includes Home, Reports, Alarms, Tanks, Lines, Sensors, Diags, RS-232, Setup, and About. The main content area shows test results for 'BIG 3 GASOLINE' at '123 POWER LN, HELENA, MT 59601'. The test type is 'PRESSURE LINE LEAK TEST RESULTS' for 'Ln 1: UNLEAD'. The results show a leak rate of 3.0 GAL/HR. The last test on SEP 12, 2008 at 4:23 PM PASSED. Summary statistics show 156 tests passed in the previous 24 hours and 110 since midnight. A list of 0.2 GAL/HR test results shows three passes on SEP 7, 2008; AUG 25, 2008; and JUL 20, 2008. The 0.1 GAL/HR results section is partially visible. At the bottom, there are buttons for 'Line Status', 'Alarm History', '0.2 Test Results', '0.1 Test Results', '0.2 Test History', and '0.1 Test History'.

VEEDER-ROOT

Home Reports Alarms Tanks Lines Sensors Diags RS-232 Setup About

SEP 12, 2008 04:30 PM

**BIG 3 GASOLINE**  
123 POWER LN  
HELENA, MT 59601  
(406) 651-2719

PRESSURE LINE LEAK TEST RESULTS

Ln 1: UNLEAD

3.0 GAL/HR RESULTS:

LAST TEST:  
LAST TEST  
SEP 12, 2008 4:23 PM PASSED

NUMBER OF TESTS PASSED:  
PREV 24 HOURS : 156  
SINCE MIDNIGHT : 110

0.2 GAL/HR RESULTS:

SEP 7, 2008 10:30 PM PASSED  
AUG 25, 2008 9:39 PM PASSED  
JUL 20, 2008 9:40 PM PASSED

0.1 GAL/HR RESULTS:

Line Status Alarm History

0.2 Test Results 0.1 Test Results

0.2 Test History 0.1 Test History

## Web Access Lines - 0.2 Test History Page

The TLS-450 Web Access Lines - 0.2 Test History page example is shown below:

The screenshot displays the Veeder-Root web interface. At the top is the Veeder-Root logo and a navigation menu with tabs: Home, Reports, Alarms, Tanks, Lines, Sensors, Diags, RS-232, Setup, and About. The main content area shows test history for two lines:

**SEP 12, 2008 04:31 PM**

**BIG 3 GASOLINE**  
**123 POWER LN**  
**HELENA, MT 59601**  
**(406) 651-2719**

**PRESSURE LINE LEAK TEST HISTORY**

**Ln 1: UNLEAD**

**LAST 3.0 PASS:** SEP 12, 2008 4:31 PM

**FIRST 0.1 PASS EACH MONTH:** JUL 20, 2008 9:55 PM

**FIRST 0.2 PASS EACH MONTH:**

- SEP 7, 2008 10:30 PM
- AUG 25, 2008 9:39 PM
- JUL 20, 2008 9:40 PM

**Ln 2: ULTRA**

**LAST 3.0 PASS:** SEP 12, 2008 4:30 PM

**FIRST 0.1 PASS EACH MONTH:** JUL 18, 2008 11:28 AM

**FIRST 0.2 PASS EACH MONTH:** SEP 7, 2008 8:41 PM

At the bottom of the interface, there are two columns of buttons:

- Left column: Line Status, Alarm History
- Right column: 0.2 Test Results, 0.1 Test Results, 0.2 Test History, 0.1 Test History

# Web Access Lines - 0.1 Test Results Page

The TLS-450 Web Access Lines - 0.1 Test Results page example is shown below:

The screenshot displays the VEEDER-ROOT web interface. At the top, there is a navigation menu with tabs for Home, Reports, Alarms, Tanks, Lines, Sensors, Diags, RS-232, Setup, and About. The main content area shows test results for two lines:

SEP 12, 2008 04:32 PM

**BIG 3 GASOLINE**  
123 POWER LN  
HELENA, MT 59601  
(406) 651-2719

**PRESSURE LINE LEAK TEST RESULTS**

**Ln 1: UNLEAD**

3.0 GAL/HR RESULTS:

LAST TEST:  
SEP 12, 2008 4:31 PM PASSED

NUMBER OF TESTS PASSED:  
PREV 24 HOURS : 157  
SINCE MIDNIGHT : 111

0.1 GAL/HR RESULTS:

JUL 20, 2008 9:55 PM PASSED

**Ln 2: ULTRA**

3.0 GAL/HR RESULTS:

LAST TEST:

At the bottom of the interface, there are several buttons: "Line Status", "Alarm History", "0.2 Test Results", "0.1 Test Results", "0.2 Test History", and "0.1 Test History".

# Web Access Lines - 0.1 Test History Page

The TLS-450 Web Access Lines - 0.1 Test History page example is shown below:

									
Home	Reports	Alarms	Tanks	Lines	Sensors	Diags	RS-232	Setup	About
<p>SEP 12, 2008 04:32 PM</p> <p><b>BIG 3 GASOLINE</b>          123 POWER LN          HELENA, MT 59601          (406) 651-2719</p> <p>PRESSURE LINE LEAK TEST HISTORY</p> <p>Ln 1: UNLEAD</p> <p>LAST 3.0 PASS:                    SEP 12, 2008 4:31 PM</p> <p>FIRST 0.1 PASS EACH MONTH:    JUL 20, 2008 9:55 PM</p> <p>Ln 2: ULTRA</p> <p>LAST 3.0 PASS:                    SEP 12, 2008 4:30 PM</p> <p>FIRST 0.1 PASS EACH MONTH:    JUL 18, 2008 11:28 AM</p>									
<input type="button" value="Line Status"/> <input type="button" value="Alarm History"/>					<input type="button" value="0.2 Test Results"/> <input type="button" value="0.1 Test Results"/>				
					<input type="button" value="0.2 Test History"/> <input type="button" value="0.1 Test History"/>				



# Web Access Sensors - Sensor Status Page

The TLS-450 Web Access Sensors - Sensor Status page example is shown below:

VEEDER-ROOT

Home Reports Alarms Tanks Lines Sensors Diags RS-232 Setup About

SEP 12, 2008 04:21 PM

BIG 3 GASOLINE  
123 POWER LN  
HELENA, MT 59601  
(406) 651-2719

LIQUID STATUS REPORT

SENSOR	LOCATION	STATUS
1	UNLEAD 2 STP SUMP	Normal
2	ULTRA STP SUMP	Normal
3	DISP 1/2 PAN	Normal
4	DISP 3/4 PAN	Normal
5	DISP 5/6 PAN	Normal
6	DISP 7/8 PAN	Normal

Select Sensor: Liquid Sensor ▼

Sensor Status Alarm History

The Status page for liquid sensors is shown. Click on the arrow beside the select sensor field to open a dropdown list of available sensors. Select one to display a similar Status page for the selected sensor. Click the Alarm History button to display the Alarm History page for the selected sensor.

## Web Access Sensors - Alarm History Page

The TLS-450 Web Access Sensors - Alarm History page example is shown below:

The screenshot shows the Veeder-Root web interface. At the top, there is a navigation menu with tabs for Home, Reports, Alarms, Tanks, Lines, Sensors, Diags, RS-232, Setup, and About. Below the menu, the main content area displays the following information:

DI30100  
 SEP 02, 2008 12:15 PM

**BIG 3 GASOLINE**  
 123 POWER LN  
 HELENA, MT 59601  
 (406) 651-2719

**LIQUID STATUS REPORT**

SENSOR	LOCATION	STATUS
1	Regular 1	Normal
2	Regular 2	Normal
3	Super	Normal

At the bottom of the page, there is a control panel with a 'Select Sensor:' label, a dropdown menu currently showing 'Liquid Sensor', and two buttons: 'Sensor Status' and 'Alarm History'.

The Alarm History page for liquid sensors is shown. Click on the arrow beside the select sensor field to open a dropdown list of available sensors. Select one to display a similar Alarm History page for the selected sensor. Click the Sensor Status button to display the Status page for the selected sensor.

# Web Access BIR - Current BIR Report Page

The TLS-450 Web Access BIR – Current BIR Report page example is shown below:

The screenshot displays the VEEDER-ROOT web interface. At the top, there is a navigation menu with buttons for Home, Reports, Alarms, Tanks, Lines, Sensors, BIR, Diags, RS-232, Setup, and About. The BIR button is selected. The main content area shows the following information:

**BIG 3 GASOLINE**  
123 POWER LN  
HELENA, MT 59601  
(406) 651-2719

MAR 10, 2010 10:25 AM

**CURRENT PERIODIC RECONCILIATION REPORT**

F 2: REGULAR  
T 2: REGULAR  
T 3: REGULAR

DATE	TIME	OPENING	METERED	MANUAL	CALC'D	PHYSICAL	WATER		
		VOLUME	DLVRIES	SALES	ADJUST	INVNTY	INVNTY	HEIGHT	VARIANCE
MAR 7	02:00 AM	2215	2678	1353	0	3540	3540	0.00	0
MAR 8	02:00 AM	3540	0	1374	0	2166	2166	0.00	0
MAR 10	02:01 AM	2166	2678	1329	0	3515	3515	0.00	0
<b>TOTALS</b>		2215	5356	4056	0	3515	3515	0.00	0

THRESHOLD: 171

SIGNATURE \_\_\_\_\_

At the bottom of the interface, there are four buttons: Current BIR Report, Current Book Report, Previous BIR Report, and Previous Book Report. A Test Results Report button is also present on the right side.

## Web Access BIR - Previous BIR Report Page

The TLS-450 Web Access BIR – Previous BIR Report page example is shown below:

VEEDER-ROOT

Home
Reports
Alarms
Tanks
Lines
Sensors
BIR
Diags
RS-232
Setup
About

**BIG 3 GASOLINE**  
**123 POWDER LANE**  
**HELENA, MT 59601**  
**(406) 651-2719**

MAR 10, 2010 10:28 AM

PREVIOUS PERIODIC RECONCILIATION REPORT

F 2: REGULAR  
T 2: REGULAR  
T 3: REGULAR

DATE	TIME	OPENING	METERED	MANUAL	CALC'D	PHYSICAL	WATER		
		VOLUME	DLVRIES	SALES	ADJUST	INVNTY	INVNTY	HEIGHT	VARIANCE
MAR 4	02:00 AM	3489	0	665	0	2824	2298	0.00	-526
MAR 5	02:00 AM	2298	2678	1363	0	3613	3613	0.00	0
MAR 6	02:00 AM	3613	0	1398	0	2215	2215	0.00	0
<b>TOTALS</b>		<b>3489</b>	<b>2678</b>	<b>3426</b>	<b>0</b>	<b>2741</b>	<b>2215</b>	<b>0.00</b>	<b>-526</b>
<b>THRESHOLD:</b>									<b>164</b>

SIGNATURE \_\_\_\_\_

# Web Access BIR - Current Book Report Page

The TLS-450 Web Access BIR – Current Book Report page example is shown below:

VEEDER-ROOT

Home	Reports	Alarms	Tanks	Lines	Sensors	<b>BIR</b>	Diags	RS-232	Setup	About
------	---------	--------	-------	-------	---------	------------	-------	--------	-------	-------

DATE	TIME	OPENING VOLUME	METERED SALES	TICKET DLVY	MAN ADJ	CLS INVENTORY	BOOK INVENTORY	GAUGED INVENTORY	DAILY VARIANCE
MAR 7	2:00 AM			0	0	469	3147	2678	= 195.90%
MAR 8	2:00 AM	1836	1367	0	0	1733	1733	0	= 0.00%
MAR 9	2:00 AM	3147	1414	0	0	376	3054	2678	= 197.35%
MAR 10	2:01 AM	1733	1357	0	0				
<b>TOTALS</b>		1836	4138	0	0	-2302	3054	5356	= 129.43%
<b>THRESHOLD:</b>									171
<b>SIGNATURE</b> _____									
F 2:REGULAR									
T 2:REGULAR									
T 3:REGULAR									

DATE	TIME	OPENING VOLUME	METERED SALES	TICKET DLVY	MAN ADJ	CLS INVENTORY	BOOK INVENTORY	GAUGED INVENTORY	DAILY VARIANCE
MAR 7	2:00 AM	2215	1353	0	0	862	3540	2678	= 197.93%
MAR 8	2:00 AM	3540	1374	0	0	2166	2166	0	= 0.00%
MAR 9	2:00 AM	2166	1329	0	0	837	3515	2678	= 201.50%
MAR 10	2:01 AM	2166	1329	0	0				
<b>TOTALS</b>		2215	4056	0	0	-1841	3515	5356	= 132.05%
<b>THRESHOLD:</b>									171
<b>SIGNATURE</b> _____									

# Web Access BIR - Current Book Report Page

The TLS-450 Web Access BIR – Current Book Report page example is shown below:

VEEDER-ROOT

Home
Reports
Alarms
Tanks
Lines
Sensors
BIR
Diags
RS-232
Setup
About

DATE	TIME	OPENING VOLUME	METERED SALES	TICKET DLVY	MAN ADJ	CLS INVENTORY	BOOK INVENTORY	GAUGED INVENTORY	DAILY VARIANCE
MAR 4	2:00 AM	3131	678	0	0	2453	1888	-565	= -83.33%
MAR 5	2:00 AM	1888	1357	0	0	531	3209	2678	= 197.35%
MAR 6	2:00 AM	3209	1373	0	0	1836	1836	0	= 0.00%
<b>TOTALS</b>		3131	3408	0	0	-277	1836	2113	= 62.00%
<b>THRESHOLD:</b>									164
<b>SIGNATURE</b> _____									
F 2:REGULAR									
T 2:REGULAR									
T 3:REGULAR									

DATE	TIME	OPENING VOLUME	METERED SALES	TICKET DLVY	MAN ADJ	CLS INVENTORY	BOOK INVENTORY	GAUGED INVENTORY	DAILY VARIANCE
MAR 4	2:00 AM	3489	665	0	0	2824	2298	-526	= -79.10%
MAR 5	2:00 AM	2298	1363	0	0	935	3613	2678	= 196.48%
MAR 6	2:00 AM	3613	1398	0	0	2215	2215	0	= 0.00%
<b>TOTALS</b>		3489	3426	0	0	63	2215	2152	= 62.81%
<b>THRESHOLD:</b>									164
<b>SIGNATURE</b> _____									

Current BIR Report

Current Book Report

Test Results Report

Previous BIR Report

Previous Book Report



# Web Access BIR - Test Results Report Page

The TLS-450 Web Access BIR – Test Results Report page example is shown below:

VEEDER-ROOT

Home	Reports	Alarms	Tanks	Lines	Sensors	BIR	Diags	RS-232	Setup	About
03-08-10	03-05-10	1 - Roll	3	4114	5356	0	171 Throughput	PASS		
03-08-10	03-03-10	2 - RollC	5	1353	2678	0	180 Capacity	PASS		
03-08-10	03-07-10	3 - Daily		1353	2678	0	157 Delivery	PASS		
03-08-10	03-04-10	4 - Roll	4	4779	5356	-526	500 Fixed	FAIL		
03-07-10	03-04-10	1 - Roll	3	3426	2678	-526	164 Throughput	FAIL		
03-07-10	03-02-10	2 - RollC	5	1398	0	0	180 Capacity	PASS		
03-07-10	03-06-10	3 - Daily		1398	0	0	130 Delivery	PASS		
03-07-10	03-03-10	4 - Roll	4	4756	5356	-535	500 Fixed	FAIL		
03-06-10	03-03-10	1 - Roll	3	3358	5356	-535	164 Throughput	FAIL		
03-06-10	03-01-10	2 - RollC	5	1363	2678	0	180 Capacity	PASS		
03-06-10	03-05-10	3 - Daily		1363	2678	0	157 Delivery	PASS		
03-06-10	03-02-10	4 - Roll	4	4791	5356	-517	500 Fixed	FAIL		
03-05-10	03-02-10	1 - Roll	3	3428	2678	-517	164 Throughput	FAIL		
03-05-10	02-28-10	2 - RollC	5	1330	2678	-9	180 Capacity	PASS		
03-05-10	03-04-10	3 - Daily		665	0	-526	130 Delivery	FAIL		
03-05-10	03-01-10	4 - Roll	4	4794	5356	-535	500 Fixed	FAIL		
03-04-10	02-27-10	2 - RollC	5	1330	2678	-9	180 Capacity	PASS		
03-04-10	03-03-10	3 - Daily		1330	2678	-9	157 Delivery	PASS		
03-04-10	02-28-10	4 - Roll	4	5530	5356	0	500 Fixed	PASS		
03-03-10	02-26-10	2 - RollC	5	1433	0	18	180 Capacity	PASS		
03-03-10	03-02-10	3 - Daily		1433	0	18	130 Delivery	PASS		
03-03-10	02-27-10	4 - Roll	4	5552	5347	17	500 Fixed	PASS		
03-02-10	03-01-10	3 - Daily		1366	2678	-18	157 Delivery	PASS		
03-02-10	02-26-10	4 - Roll	4	4744	5347	-9	500 Fixed	PASS		
03-01-10	02-26-10	1 - Monthly		3378	2668	10	164 Throughput	PASS		
03-01-10	02-28-10	3 - Daily		1401	0	9	130 Delivery	PASS		
03-01-10	02-26-10	4 - Roll	3	3378	2669	9	500 Fixed	PASS		

Current BIR Report

Current Book Report

Test Results Report

Previous BIR Report

Previous Book Report

## Web Access Diags Page

The TLS-450 Web Access Diags page example is shown below:

**VEEDER-ROOT**

Home Reports Alarms Tanks Lines Sensors BIR Diags RS-232 Setup About

MAR 10, 2010 10:30 AM

SOFTWARE: 342002.A.121.2 CREATED: Feb 21 2010 15:58:17

Hardware Description	Serial Numbers
CPU	YYWXXXXX
iButton	000000bc4e090b
UNIVERSAL SENS MODULE (B1.S1)	656641
INPUT/OUTPUT MODULE (B1.S2)	656802
INPUT/OUTPUT MODULE (B8.S5)	4278190081

Installed Features

-----

Total Control

- \* Email Notification
- \* Custom On-Board Help
- \* Custom Alarms
- \* Custom Dashboard

TLS-450 Direct Access™ Software/Web Browser  
 Business Inventory Reconciliation  
 AccuChart II  
 Base Compliance Line Leak Detection For DPLD

Refresh System Revision

This page displays information about software/features installed in this TLS-450 console.



## Web Access RS-232 Page

The TLS-450 Web Access RS-232 page example is shown below:

The screenshot shows the Veeder-Root web interface for RS-232 access. The top navigation bar includes the Veeder-Root logo and a blue header. Below the header is a menu with tabs for Home, Reports, Alarms, Tanks, Lines, Sensors, BIR, Diags, RS-232, Setup, and About. The main area is a large empty terminal window. At the bottom, there is a text input field, a 'Clear' button, and a 'Reset Connections' button. Below the input field, the text '(Enter Serial Command. No <CTRL-A>)' is displayed.

This page lets you access query the TLS-450 using Veeder-Root RS-232 published commands. Type in the serial command `Ixxxxxx`, e.g., `I20200` (delivery report), in the field below the terminal window, click Enter and the TLS-450 will display the Delivery Report in the terminal window . Click the Clear button to clear the terminal window. Click the Reset Connections button and re-enter the command if the requested report does not display.

## Web Access Setup Page

The TLS-450 Web Access Setup page example is shown below:

The screenshot shows the VEEDER-ROOT Web Access Setup page. The header includes the VEEDER-ROOT logo and a navigation menu with tabs: Home, Reports, Alarms, Tanks, Lines, Sensors, BIR, Diags, RS-232, Setup, and About. The main content area is divided into two columns. The left column contains a checkbox labeled "Security Code Enable" and an empty text input field below it. The right column contains a checked checkbox labeled "Auto Refresh", a "Refresh Time" dropdown menu set to "30 Seconds", and a "Refresh Tabs" section with checkboxes for Home (checked), Reports, Alarms, Tanks, Lines, Sensors, Diags, and BIR.

### Web Access Security Password

To enable a security code to restrict access to the TLS-450 via Web Access, click the Security Code Enable box in this page and enter up to a six alph-numeric password in the field below.

### Auto Refresh Page Data

To automatically refresh page data, click the box next to Auto Refresh. Click the arrow beside the Refresh Time field and select a page refresh time of from 10 to 60 seconds. Click the boxes beside any of the Refresh Tabs to apply the Auto Refresh setting to that page's data.

## Web Access About Page

The TLS-450 Web Access About page example is shown below:

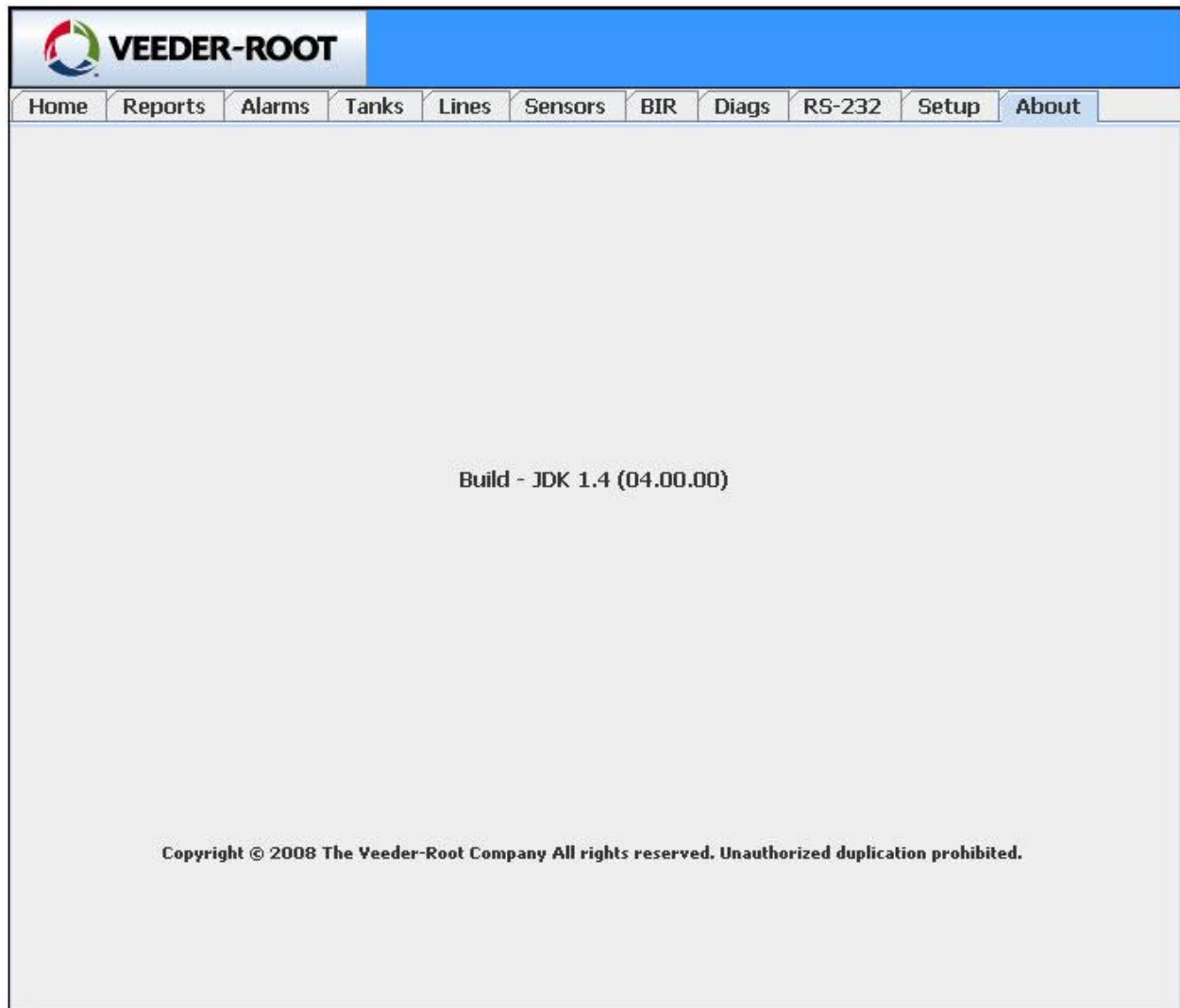

This page displays the version of Veeder-Root's Web Access software installed in the TLS-450 console.

